

Commercial Office

PRICE LIST

Effective January 1, 2017



FLEXSTEEL®

CONTRACT

DMI COLLECTION



NOTE: Prices shown herein are subject to change without prior notice. We reserve the right to make changes in design or construction detail without notice. **ALL ONLINE PRICING SUPERSEDES PRINTED MEDIA.**

Policies & Procedures

Ordering Information and Policies & Procedures 2

Traditional

Veneer Antigua 7480 11
 Balmoor 7688 15
 Keswick 7990 (GSA) 19
 Rue De Lyon 7684 31
 Walden 7859 37

Laminate Governors 7350 (GSA) 41

Contemporary / Transitional

Veneer Belmont 7130 / 7132 47
 Del Mar 7302 57

Laminate Causeway 7040 / 7041 / 7042 / 7043 / 7047 63
 Fairplex 7003 / 7004 / 7005 / 7006 / 7007 79
 Inigo 7011 / 7012 104
 Pimlico 7020 / 7027 (GSA) 105

Writing Desk

Veneer Writing / Table Desks 131

Conference Applications

Veneer Conference Tables 133

Laminate Conference Tables 142

Buffets 149
 Presentation Boards 150

Occasional Tables

Veneer Occasional Tables 151
 Made-to-Order Occasional Tables 154

Seating Solutions

Made-to-Order
 Collections 155
 Accent Chairs 162
 Ottomans & Benches 168
 Recliners 171
 Zoll 172

In-Stock Executive, Management, & Task Chairs 173
 Guest Chairs 175
 Collections (GSA) 177
 Zoll 179
 Ottomans 180

Office Accessories 181



Policies & Procedures



FLEXSTEEL®
CONTRACT

Stocked Merchandise

Conditions Of Sale

Payment terms on shipments from our Huntingburg, Indiana Distribution Center are Net 30 days. Prices are subject to change without notice. Shipping weights and cubes are estimated and are also subject to slight variations. FLEXSTEEL CONTRACT reserves the right to make changes in design and construction detail without notice. All orders are subject to acceptance by FLEXSTEEL CONTRACT. The mailing or distribution of this price list does not constitute an offer to sell. Cancellations will not be accepted unless they are received and acknowledged by the FLEXSTEEL CONTRACT Customer Service Department. Additional terms and conditions as found on FLEXSTEEL CONTRACT acknowledgements, invoices and other official communications may be considered as part of these "Conditions of Sale".

FLEXSTEEL CONTRACT Shipping Policy - Delivered Customers

- "Delivered" pricing includes freight when FLEXSTEEL CONTRACT ships by one of our contracted, dedicated, delivered furniture carriers within the continental US (excludes Alaska, Hawaii and the Florida Keys). Additionally, the receiving docks must be able to accommodate a 75' truck without having to directly back in from and back out onto a street. Standard shipping time is ten working days or less. Depending on the ship to location however, delivery may take two to three weeks.
- All orders are subject to a fuel surcharge.
- Minimum order requirement \$650 net; orders less than \$650 net will be assessed a handling charge of \$75.
- Requests by customers for orders to ship by carriers other than our contracted carriers for any reason, including but not limited to inaccessibility or length of time to delivery, are not considered part of the "Delivered" program. Such orders are not eligible for our Delivered Pricing and freight charges become the responsibility of the ordering entity. Such orders will ship pre-paid and add or third party delivery if the ordering entity makes arrangements for shipping. In these instances FLEXSTEEL CONTRACT will offset the freight charges incurred by the ordering entity by giving an additional 5% discount off LIST pricing. Arrangements for the additional 5% discount must be discussed with our Customer Service Department prior to delivery of the order.
- Added freight charges incurred for special handling to include but not limited to Lift Gate Delivery, Inside Delivery, White Glove Delivery are not included in our "Delivered" program and are the responsibility of the ordering entity and subject to a freight invoice from FLEXSTEEL CONTRACT.
- Delays in delivery resulting in fees due to incorrect or insufficient delivery address and/or delivery instructions not noted on the customer's purchase order are the responsibility of the ordering entity and FLEXSTEEL CONTRACT will invoice the ordering entity for such charges when they occur.
- Added "fees" as a result of "transfers" of freight, i.e. to smaller trucks due to inaccessibility with a 75' truck, (sometimes referred to as "residential delivery") are the responsibility of the ordering entity and FLEXSTEEL CONTRACT will invoice the ordering entity for such charges when they occur.
- No returns will be accepted without prior written authorization from FLEXSTEEL CONTRACT.
- All returns are subject to a restocking fee of 35% unless there is a prior agreement with FLEXSTEEL CONTRACT management.
- Only merchandise in unopened cartons will be considered for return authorization.
- Freight claims are the responsibility of the consignee and/or the billed to party.

DASH "Quick Ship" Program Shipping Policy - Delivered Customers

- This is a delivered "DEALER ONLY" program
- Excludes Holidays, weekends and other unforeseen circumstances beyond FLEXSTEEL CONTRACT's control
- DASH orders entered after 1PM EST will be considered next business day orders
- In order to process correctly, DASH orders must be clearly marked as "DASH" in the body of the customer order and the customer PO must be priced accordingly
- Minimum order size of \$1800 net or \$200 charge will be added
- Flexsteel Seating products or other FLEXSTEEL CONTRACT "lead time" products do not apply (Xtables with installed data ports and 7990 HPL)
- DASH purchase orders are not to be combined with regular customer POs
- For this quick delivery program, there will be a 5% charge to the dealer added to the invoice
- Standard freight policies apply as listed in the FLEXSTEEL CONTRACT price list
- Orders must be for DOCK delivery only
- FLEXSTEEL CONTRACT is not responsible for returned freight charges
- Without FLEXSTEEL CONTRACT consent, DASH orders received by FLEXSTEEL CONTRACT are noncancellable

FLEXSTEEL CONTRACT Shipping Policy - FOB Customers

- Unless otherwise agreed to by FLEXSTEEL CONTRACT management all LTL/drop ship shipments must be palletized & banded and are subject to a 5% pallet/drop ship charge.
- Prepaid and add orders are subject to a fuel surcharge.
- Freight prepaid and add shipments are subject to handling charges.
- Orders must specify the freight carrier to be used.
- Orders must specify either freight collect or 3rd party freight billing.
- Added freight charges incurred for special handling to include but not limited to Lift Gate Delivery, Inside Delivery, White Glove Delivery are the responsibility of the ordering entity.
- Delays in delivery resulting in fees from "storage" due to incorrect delivery address/instructions or insufficient delivery address or/ instructions not noted on the customer's purchase order are the responsibility of the ordering entity.
- Delays in delivery resulting in fees from "transfers" of freight, i.e. to smaller trucks due to inaccessibility, are the responsibility of the ordering entity.
- Freight claims are the responsibility of the consignee and/or the billed to party.
- No returns will be accepted without prior written authorization from FLEXSTEEL CONTRACT.
- All returns are subject to a restocking fee of 35% unless there is a prior agreement with FLEXSTEEL CONTRACT management.
- Only merchandise in unopened cartons will be considered for return authorization.

Returns And Allowances Policy

ONLY merchandise in unopened cartons will be considered for a return authorization. All returns, except for defective product, are subject to the appropriate restocking fee unless there is a prior agreement from FLEXSTEEL CONTRACT. Defects in FLEXSTEEL CONTRACT merchandise should be reported to the local FLEXSTEEL CONTRACT sales representative. The FLEXSTEEL CONTRACT sales representative is expected to inspect and report on all defective merchandise and report results of inspection to FLEXSTEEL CONTRACT's Customer Service Department. FLEXSTEEL CONTRACT's Customer Service must authorize all claims. No returns, allowances, or deductions from invoices, of any kind, will be accepted without prior written authorization. Any freight charges incurred by an unauthorized return will be invoiced to the FLEXSTEEL CONTRACT customer.



Stocked Merchandise

FLEXSTEEL CONTRACT designs and tests its products and packaging to ensure they meet or exceed furniture transport standards generally accepted in the industry. Therefore, damaged merchandise and concealed freight damage is the responsibility of the freight carrier. Claims must be filed by Consignee with the delivering freight carrier within five days of receipt of shipment. FLEXSTEEL CONTRACT accepts no responsibility for merchandise shortages or damages caused by freight carriers or consumer delivery services.

The transportation company is responsible for safe delivery of product. FLEXSTEEL CONTRACT customers should inspect all merchandise upon delivery of shipment. Any visible damage should be noted on the freight bill, signed and dated by the person accepting the delivery. In order for a concealed damage claim to be accepted it must be filled within 5 days of receipt of merchandise with the carrier. Merchandise moved from original delivery location will not qualify for concealed damage claims. Always retain the carton for possible inspection by the carrier.

Deluxing / Touch-Up

FLEXSTEEL CONTRACT strives to maintain a constant quality standard on all its products. However it is part of the FLEXSTEEL CONTRACT customers' responsibility to do a certain amount of touch-up, deluxing and, if needed, installation of replacement parts. We do not recommend that the merchandise be delivered to the consumer in the original packages from the factory.

US Distribution Center Product Pick-Up Policy

FLEXSTEEL CONTRACT Our US Distribution Center is located in Huntingburg, IN (47542). Hours of operation are 7:30am to 3:00pm Eastern Time. All product pick-ups require a dock appointment 48 hours in advance. Dock appointments are to be scheduled with the Distribution Center: phone 812-683-2123; fax 812-683-4865. All product is shipped FOB our Distribution Center. All claims for damages are to be directed to the carrier picking up the merchandise. Drivers are welcome to observe the loading of the product.

Product Warranties to the End User

- Laminate and veneer casegoods LIFETIME LIMITED WARRANTY
- Flexsteel Lounge Seating products FIVE YEAR LIMITED WARRANTY
- Office chairs TWO YEAR LIMITED WARRANTY except for THREE YEAR LIMITED WARRANTY on Pantera and Lotus chairs and ONE YEAR WARRANTY on "mesh" portion of these listed chairs.
- THREE YEAR WARRANTY on Sit-to-Stand base
- FIVE YEAR WARRANTY on Sit-to-Stand motor

Consumer Warranty Statement: If you notice a defect, it is important for you to act promptly and immediately notify the Authorized Retailer from whom you purchased your furniture. Your notification must be given to an authorized FLEXSTEEL CONTRACT dealer with proof of purchase. After notification, it may be necessary for the Authorized Dealer or the manufacturer to arrange for an inspection of your furniture to determine whether or not a covered defect exists. If a covered defect does exist, it will be repaired. If it is determined that repair is not practical; you will be supplied with new furniture of the same or similar color, design, style and quality at the current price less depreciated value of the product as based on ASB standards for straight line depreciation of Office Furniture. You will not be charged for any repair services, delivery costs.

No implied warranties, including warranties of merchantability or fitness for a particular purpose exist. By implied warranties, we mean ones that the law requires to have been given by the seller even though they are not set out in writing. Please note: some states do not allow exclusion or limitation on how long an implied warranty lasts, so the above limitation or exclusion may not apply to you.

While we believe our limited warranty is a good one, there are some limits to it. Any of the following things reduce the manufacturer's responsibility under this warranty:

- This limited warranty protects you only when you purchase furniture from an Authorized Dealer and if you are the original owner of the product.
- This limited warranty applies only when you have purchased the furniture for your own use and not for resale prior to use.

Your furniture requires some routine maintenance. Keep it clean, dusted and polished as necessary. Proper care and use are essential to preserving the rights under this limited warranty. We will not repair or replace your furniture if damage is caused by improper maintenance or by improper use.

This limited warranty does not cover damage resulting from abuse, normal wear and tear, and accidents including burns, cuts, scratches, scuffs, watermarks or indentations.

Consequential or incidental damages are not covered under this limited warranty. By this we mean any loss, expense or damage other than to the furniture itself that may result from a defect in the furniture. Please note: some states do not allow the exclusion or limitation of incidental or consequential damages, so the above limitation or exclusion may not apply to you.

Ordering Information

All orders should be mailed or faxed to:
FLEXSTEEL CONTRACT
Ste 2000
9780 Ormsby Station Road
Louisville KY 40223

Customer Service Phone: (888) 372-1927
Customer Service Fax: (800) 755-2878

Product Design and Specification Charges: FLEXSTEEL CONTRACT reserves the right to make changes in design and construction or discontinue products without prior notice.



CONDITION OF SALES

PRICES

CREDIT REQUIREMENTS

New Accounts

A complete credit application, including a financial statement and trade references, along with a 50-percent minimum deposit, must accompany your first order. If you choose not to meet our credit requirements, we will require the invoice balance before delivery. A complete credit analysis of business condition will determine the amount of credit which will be extended. You will be advised upon credit review as approved or denied.

Terms and Credit Procedures

1. Net 30 days from date of invoice on all accredited accounts.
2. Fifty-percent minimum down payment on all orders that exceed the established line of credit.
3. If balance due on the order, after the down payment of 50 percent, still exceeds the credit limit, purchaser must remit the portion of the balance that exceeds the established credit limit before delivery.
4. Our internal controls place all current orders on shipping hold if your account is in a past-due status.
5. All overdue accounts will be subject to a finance charge of 2 percent per month on the unpaid balance.
6. If it has been longer than 18 months since purchaser last placed an order, a new credit application must accompany the order. A credit review will determine purchaser's current line of open credit.
7. Our credit policies must be strictly adhered to if we are to meet delivery requirements; failure to meet our credit requirements may delay the order.

AGENT'S AUTHORITY

Purchaser understands and agrees that no agent, employee or representative of FLEXSTEEL CONTRACT has authority to bind Flexsteel Industries, Inc. to any affirmation, agreement, representation or warranty concerning the goods, and purchaser further understands and agrees that such affirmation of fact, promise or representation made by any agent, employee or representative of FLEXSTEEL CONTRACT shall not constitute a warranty or agreement unless specifically approved in writing by an authorized officer of FLEXSTEEL CONTRACT

QUOTATIONS

All quotations must be in writing from FLEXSTEEL CONTRACT and will expire if not accepted within 60 days of issuance, unless stated otherwise on the written quotation. In addition, force majeure (extraordinary costs due to hyper-inflation) overrides all quotations and orders in house.

ORDERS & CHANGES

All orders should be mailed or faxed to:

FLEXSTEEL CONTRACT
Ste 2000
9780 Ormsby Station Road
Louisville KY 40223

Customer Service Phone: (888) 372-1927

Customer Service Fax: (800) 755-2878

Orders are binding upon issuance of the FLEXSTEEL CONTRACT acknowledgment. Order changes are subject to our ability to conform and cannot be accepted after the fabric has been cut. We reserve the right to charge for processing order changes.

CANCELLATIONS

Orders may not be cancelled without written authorization from FLEXSTEEL CONTRACT. Where cancellations are possible, a cancellation charge may be required. Custom-order items cannot be cancelled.

SHIPPING

Ship/Delivery Dates

All orders are produced and shipped in full unless quotation specifies otherwise. Partial fabric delays will result in a delay of the entire order unless a new quotation is issued for the project. Shipping instructions are required in writing on the purchase order.

Storage/Construction Delay

Charges for storage will be assessed on all items not accepted by customer within one week (seven days) of scheduled delivery date at **5 percent of net invoice, per month.**

Claims

It is the purchaser's responsibility to check all items upon receipt of shipment for concealed damage and loss. All freight damage or loss claims **must be filed by consignee with the transportation company within five working days upon receipt of said shipment.** This also applies to items shipped via FLEXSTEEL CONTRACT's truck. Failure to make any claim against Flexsteel or the transportation company **within 10 working days shall constitute acceptance of the merchandise** and a waiver of any defects, errors, or shortages ascertainable upon inspection.

Returns

Merchandise cannot be returned without written authorization from our Customer Service Department. Unauthorized returns will not be accepted and will be returned to the customer.

FLEXSTEEL CONTRACT RESERVES THE RIGHT TO IMPROVE THE PRODUCT CONSTRUCTION AND SPECIFICATIONS WITHOUT PRIOR NOTICE.



FABRIC INFORMATION

CARDED FABRIC

Flexsteel offers customers an extensive carded program to help achieve the look and feel desired. Fabrics are offered in a variety of grades, patterns, and colors. Flexsteel also has the capability to grade in fabrics upon request. All fabrics are warranted for one year.

FLAME RETARDANT TREATMENTS

Many upholstery materials stocked by Flexsteel typically meet more stringent fire codes and test methods. Current information about a specific pattern is listed on the individual fabric cards, textile binder, and textile price list.

If materials, as stocked, do not meet your specific flame-retardant requirements, please contact Flexsteel to see if further treatment is available.

Most flame-retardant treatments are salt solutions. Cleaning these fabrics with water or water-based foams will result in salt ringing. Solvent-based fabric cleaners or dry cleaning are alternate methods of cleaning. However, you are cautioned to test proposed cleaning procedures on a small portion of fabric before proceeding with the cleaning of the entire installation.

Flexsteel Industries, Inc. is using state-of-the-art, fire-retardant materials that provide a product that will comply with California Technical Bulletin 133. Each product is produced using TB 117 treated HR foam and a fire-retardant barrier material. The upcharge for TB 133 is \$25 per yard (net), based on the yardage shown in the price list. If a written certification is required, a complete burn test is needed. It will cost half of the price of the piece of furniture with exact fabric used, freight, and \$450 (half the cost of the test). Styles that have buttons, sewn pulls, or any sewn type of detail may not be able to meet California TB 133.

No order will be accepted using any fabric containing more than 10-percent olefin.

CUT YARDAGE

Cut Yardage List Prices

Listed below are the per-yard prices for 54"-wide fabrics and vinyls. These coverings are shipped FOB plant or mill.

Grade	List Price	Grade	List Price
4	\$40.00	16	\$114.00
6	\$52.00	18	\$126.00
8	\$62.00	20	\$136.00
10	\$72.00	22	\$146.00
12	\$92.00	24	\$156.00
14	\$104.00	26	\$168.00

Policies & Procedures



FLEXSTEEL®
CONTRACT

Made-To-Order Merchandise

Lead Times

Lead time for in-line product is a minimum of 6-8 weeks dependent on fabric and credit availability.

Please note, all lead times are subject to change and longer lead times may apply.

WARRANTIES

All warranty time periods begin from date of delivery.

One-Year Warranty

1. FLEXSTEEL CONTRACT warrants its wood-exposed/show-wood frame products to be free from defects in materials and workmanship for one year from the date of delivery. During this period, at its option, Flexsteel will repair or replace, free of charge, products that prove to be defective.

Five-Year Warranty

1. All FLEXSTEEL CONTRACT fully upholstered styles carry a five-year warranty on the drop-in sinuous wire (zigger) unit, wood frame, and seat cushion. This warranty is based on conditions of normal use. If problems occur during the stated timeline, FLEXSTEEL CONTRACT will review incidents and determine whether or not a repair or replacement is qualified. Repairs and replacements will be free of charge on all qualified products.
2. Applies to furniture manufactured with web seat foundation. FLEXSTEEL CONTRACT warrants the web seat foundation and hardwood seat frame against breakage under conditions of normal use. This warranty is based on conditions of normal use. If problems occur during the stated timeline, FLEXSTEEL CONTRACT will review incidents and determine whether or not a repair or replacement is qualified. Repairs and replacements will be free of charge on all qualified products.
3. All FLEXSTEEL CONTRACT recliners carry a five-year warranty on the Flexsteel seat spring unit, wood frame, and recliner mechanism. All other parts, base unit, lumbar support, articulated headrest, and the power motor on the electric lift recliner carry a one-year warranty. These warranties are based on conditions of normal use.
4. Applies to the 2.5 (HR) high-resiliency, high-density urethane foam seat cushion and to the plush cushion (PC) when used on fully upholstered product.

Seven-Year Warranty

1. Applies to only the Flexsteel blue steel seat spring and frame. Flexsteel warrants these products against breakage under conditions of normal use. If problems occur during the stated timeline, Flexsteel will review incidents and determine whether or not a repair or replacement is qualified. Repairs and replacements will be free of charge on all qualified products.

Warranties not expressly stated herein, including without limitations any implied warranties or merchantability and fitness for purpose, are excluded and disclaimed by FLEXSTEEL CONTRACT. FLEXSTEEL CONTRACT will make every effort to make on-time deliveries; however, we are not responsible for loss of revenue due to late delivery.

Flexsteel shall not in any event be liable for the cost of any special direct, indirect, incidental, or consequential damages to anyone due to the breach on any warranty hereunder. FLEXSTEEL CONTRACT's sole obligation shall be to repair or replace any product that proves defective during the warranty period.

Whenever a special wood finish is requested, FLEXSTEEL CONTRACT will attempt to match for color but does not assume responsibility for color variation resulting from this finish being applied to various hardwoods.

The above warranties do not apply to damage resulting from accident, alteration, misuse, negligence, abuse, or abnormal wear.

WARNINGS

Users are urged to make PERIODIC INSPECTIONS to look for damages or signs of structural fatigue incurred in daily handling, use, and abuse. Examinations must include structural joints, corner blocks, and other points of stress. If defects are found, the product should be taken out of service.

CONSTRUCTION INFORMATION

Frame Construction

The Flexsteel frame is precision engineered, combining select kiln-dried hardwoods and laminates, using up-to-date materials and technology to create a stronger, more durable, integral frame structure that is solid, stable, and long lasting. This technology not only helps conserve precious tree resources but also uses hardwood materials that might otherwise be wasted. Standard product, unless otherwise specified, meets CAL TB117.

Seat Construction

The following types of constructions are engineered for each item and are not interchangeable.

FLEXSTEEL SPRING: DUALFLEX® SYSTEM

Features a blue steel banded platform and helical coil springs to enhance seat comfort and durability.

SINUOUS WIRE SPRING

Resilient sinuous high-carbon steel wire construction provides firm comfort.

WEB SEATING SUPPORT SYSTEM

Web is especially suited for incontinence management. It is unaffected by mildew, fungus, bacteria or urine. It has excellent strength and durability and has passed the BIFMA Cycling & Drop Test. It also meets flammability standards of UFAC Class I, NFPA 260A Classes and California TB117.

FLEXSTEEL CONTRACT DROP-IN ZIGGER UNIT

The FLEXSTEEL CONTRACT drop-in zigger unit features a unitized frame made of tubular steel.



CUSHIONING

Seat Cushions

FLEXSTEEL CONTRACT uses the highest quality urethane foam to provide comfort as well as durability. Our Design and Engineering Team determines the standard foam to be used at the time of product development. Designers select from either a 2.5-density (HR) urethane foam or a 1.8- density (LC) luxury comfort, high-density urethane, both meeting California TB117. Optional seat cushion is the 2.75 combustion modified, high-resiliency foam (CMHR).

Loose-Back Pillows

A core of pure, polyurethane foam with layers of polyester fibers bonded to both sides of the core providing comfort and shape.

Flame-Retardant Foams And Fabrics

For questions concerning flame-retardant foams and fabrics contact the Customer Care Department or your Flexsteel Hospitality Sales Representative.

Flame-Retardant Mattresses

All innerspring mattresses are manufactured to meet the requirements of U.S. Flammability Specification DOC FF4-72 as revised and California Technical Bulletin 1633. The DreamFlex mattress is UL approved. If this does not meet your specific flame-retardant requirement, innerspring mattresses can be manufactured with FireGuard, a special fiberglass, fire-blocking ticking. This ticking is manufactured by Springs Industries, which certifies that it passes NFPA 701 Small Scale and MVS 302 tests. A net upcharge of \$55.00 per mattress will be applied.

GENERAL PRODUCT INFORMATION

The descriptions and pictures contained in all catalogs or sales literature are based upon construction techniques in use at the time of publication. From time to time, new methods and materials become available which can improve quality and durability. FLEXSTEEL CONTRACT reserves the right to incorporate new materials or make changes in tailoring or frame without prior notice.

All weights and sizes shown in this price list are approximate. Special Note: Regarding recliners, if the recliner is being purchased for installation in a fire house Flexsteel will only warrant the Fire Fighter Recliners for use in this environment.

CHAISE INFORMATION

Flexsteel determines left from right by standing at the foot end of the chaise and facing the length of the piece. This determines the standard for left (-25) and right (-26).

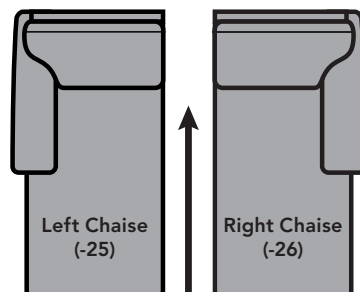

ARM CAPS

List Price

Arm caps are not standard but are available upon request on items with fully upholstered arms.

The list DPG (Difference per Grade) is \$15.00 per pair.

For example: one pair of arm caps in a Grade 6 fabric = \$50.00 + \$30.00 (2 DPG x \$15.00) = \$80.00 list price.

One pair arm caps Grade 4 fabric list price \$50.00.

WOOD FINISHES

Flexsteel uses maple for exposed wood trim. Refer to the commercial wood finish samples or www.FlexsteelHospitality.com for color representation of each finish.

Standard Finishes

Classic Cherry – Code: 35"G"
 Formal Mahogany – Code: 35"W"
 Wild Cherry – Code: 35"N"
 Honey – Code: 35"2"
 Natural – Code: 35"=
 Roast – Code: 35"\ and 34"1"
 Florentine – Code: 35"&"
 Java – Code: 35">"
 Valencia – Code: 35"<"
 Old Vine – Code: 35"X"
 Pecan – Code: 35"C"
 Ebony – Code: 35"9"
 Harbor – Code: 35"\ and 34"L"
 Smoke – Code: 35"\ and 34"E"
 Drift – Code: 35"\ and 34"3"

*For best results, Natural Finish is recommended on Beech frames.

Upon request, Flexsteel Customer Care will mail an individual wood finish sample for purchaser's reference.

FlexGuard Super Poly Finish

Standard on all FLEXSTEEL CONTRACT products is a special finish developed for contract applications. FlexGuard is applied as a topcoat to all hospitality and healthcare exposed wood trim. It forms a tough, protective barrier, resisting stains and minor surface abrasions. It is considerably more wear resistant than regular lacquer or varnish finishes.



FABRIC PATTERNS BY NUMBER

Fabric Number	Double Rubs	Fabric Grade	TB133	Fabric Number	Double Rubs	Fabric Grade	TB133	Fabric Number	Double Rubs	Fabric Grade	TB133
B00	51,000	28	A	D59	100,000	22	A	Leather			
B01	51,000	28	A	D60	100,000	4	N	D45	N/A	L8	N
B02	51,000	24	A	D61	50,000	6	N	D46	N/A	L12	N
B03	51,000	24	A	D62	80,000	6	N	D47	N/A	L21	N
B04	51,000	24	A	D63	500,000	16	A	TB133 Definition:			
B05	51,000	24	A	D64	500,000	16	A	A = Fabric has shown that when used in conjunction with a fire barrier material and proper polyfoam, it will meet the requirements of California TB133.			
B06	51,000	24	A	D65	200,000	18	N	N = Fabric has shown that when used in conjunction with a fire barrier material and proper polyfoam, it will not meet the requirements of California TB133.			
B07	51,000	24	A	D66	50,000	18	N	NOTE: FOR DOUBLE RUBS NOT LISTED, REFER TO FABRIC CARD			
B08	51,000	24	A	D67	100,000	14	N				
B09	51,000	28	A	D68	100,000	12	N				
B10	51,000	24	A	D69	100,000	14	N				
B12	51,000	24	A	D70	80,000	12	N				
B13	51,000	24	A	D71	100,000	16	N				
B14	51,000	28	A	D72	150,000	14	N				
B15	51,000	24	A	D73	200,000	10	N				
B16	51,000	24	A	D74	200,000	10	N				
B18	51,000	24	A	D75	200,000	10	N				
B19	51,000	24	A	D76	200,000	10	N				
B20	51,000	24	A	D77	200,000	10	N				
B21	51,000	28	A	D78	51,000	6	N				
B22	51,000	28	A	D79	50,000	8	N				
B32	51,000	24	A	D80	100,000	20	A				
B34	100,000	16	A	D81	300,000	20	A				
B35	50,000	16	A	D82	100,000	20	A				
B36	50,000	20	A	D83	500,000	20	A				
B37	50,000	16	A	D84	300,000	20	A				
B38	50,000	18	A	D85	300,000	20	A				
B39	50,000	18	A	D86	100,000	20	A				
B40	51,000	24	A	D87	100,000	20	A				
B41	50,000	18	A	D88	300,000	20	A				
B42	50,000	18	A	D89	100,000	20	A				
B43	51,000	16	A	D90	100,000	20	A				
B44	51,000	12	A	D91	100,000	20	A				
B48	51,000	12	A	D92	100,000	20	A				
B49	40,000	4	N	D93	100,000	20	A				
B50	200,000	4	N	D94	300,000	20	A				
B62	51,000	12	A	D95	100,000	20	A				
B63	54,000	12	A	D96	500,000	20	A				
B65	51,000	24	A	D97	100,000	20	A				
B74	500,000	12	A	D98	300,000	20	A				
B76	435,000	14	A	D99	100,000	20	A				
B93	40,000	6	N	E31	102,000	8	A				
B95	30,000	4	N	E34	102,000	6	A				
C00	500,000	32	A	E62	100,000	10	A				
C01	300,000	32	A	E86	204,000	18	A				
C02	300,000	32	A	E87	50,000	18	A				
C03	400,000	34	A	E88	138,000	18	A				
D16	30,000	4	N	E89	210,000	18	A				
D17	60,000	4	N								
D18	50,000	4	N								
D19	100,000	10	A								
D30	240,000	10	A								
D32	100,000	8	N								
D34	192,000	6	N								
D42	100,000	8	A								
D43	200,000	6	N								
D44	125,000	4	N								
D48	100,000	34	A								
D49	1,300,000	16	A								
D50	100,000	20	A								
D51	100,000	34	A								
D52	100,000	24	A								
D53	100,000	44	A								
D54	100,000	34	A								
D55	500,000	16	A								
D56	100,000	40	A								
D57	100,000	34	A								
D58	100,000	44	A								



FABRIC PATTERNS BY GRADE

Fabric Number	Fabric Grade	Fabric Number	Fabric Grade	Fabric Number	Fabric Grade
B95.....	.04	B36.....	20	Leather	
D16.....	.04	D50.....	20	D45.....	L08
B49.....	.04	D80.....	20	D46.....	L12
D18.....	.04	D82.....	20	D47.....	L21
D17.....	.04	D86.....	20		
D60.....	.04	D87.....	20		
D44.....	.04	D89.....	20		
B50.....	.04	D90.....	20		
		D91.....	20		
B93.....	.06	D92.....	20		
D61.....	.06	D93.....	20		
D78.....	.06	D95.....	20		
D62.....	.06	D97.....	20		
E34.....	.06	D99.....	20		
D34.....	.06	D81.....	20		
D43.....	.06	D84.....	20		
		D85.....	20		
D79.....	.08	D88.....	20		
D32.....	.08	D94.....	20		
D42.....	.08	D98.....	20		
E31.....	.08	D83.....	20		
		D96.....	20		
D19.....	.10				
E62.....	.10	D59.....	22		
D73.....	.10				
D74.....	.10	B02.....	24		
D75.....	.10	B03.....	24		
D76.....	.10	B04.....	24		
D77.....	.10	B05.....	24		
D30.....	.10	B06.....	24		
		B07.....	24		
B44.....	.12	B08.....	24		
B48.....	.12	B10.....	24		
B62.....	.12	B12.....	24		
B63.....	.12	B13.....	24		
D70.....	.12	B15.....	24		
D68.....	.12	B16.....	24		
B74.....	.12	B18.....	24		
		B19.....	24		
D67.....	.14	B20.....	24		
D69.....	.14	B32.....	24		
D72.....	.14	B40.....	24		
B76.....	.14	B65.....	24		
		D52.....	24		
B35.....	.16				
B37.....	.16	B00.....	28		
B43.....	.16	B01.....	28		
B34.....	.16	B09.....	28		
D71.....	.16	B14.....	28		
D55.....	.16	B21.....	28		
D63.....	.16	B22.....	28		
D64.....	.16				
D49.....	.16	C01.....	32		
		C02.....	32		
B38.....	.18	C00.....	32		
B39.....	.18				
B41.....	.18	D48.....	34		
B42.....	.18	D51.....	34		
D66.....	.18	D54.....	34		
E87.....	.18	D57.....	34		
E88.....	.18	C03.....	34		
D65.....	.18				
E86.....	.18	D56.....	40		
E89.....	.18				
		D53.....	44		
		D58.....	44		



Antigua

VENEER COLLECTION

7480 West Indies Cherry Finish

Enchanting details with casual refinement.

Bring a feeling of lush warmth to your small office with a classic design inspired by easy island living. The Antigua Collection sports marquetry cherry veneer tops and refined touches like fluted columns and carved wood knob feet.

Details:

- Construction consists of veneer constructed on wood and wood product and includes mortise and tenon, wood cleats, screws, staples and threaded inserts or bolts for strength and durability
- Top surfaces are constructed of Marquetry cherry veneers with wood substraight and NC lacquer finish
- All drawers feature a four sided plywood construction with dovetail joints and sealed interiors and are suspended on metal ball bearing slides
- Locking drawers are all keyed the same. If you need specific items keyed differently, please contact your customer service representative
- Box drawers feature a 3/4 extension and rated for 75 lbs
- File drawers are fully extending and rated for 150 lbs
- File drawers equipped with metal rods for letter or legal sized hanging files
- Adjustable floor levelers
- Cable accessible
- Minor assembly required



FLEXSTEEL®
CONTRACT

DMI COLLECTION



Antigua VENEER COLLECTION



FLEXSTEEL®
CONTRACT

7480 West Indies Cherry Finish



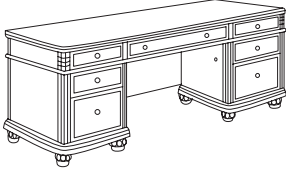
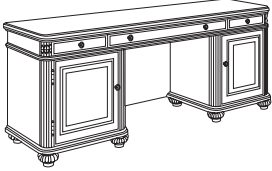
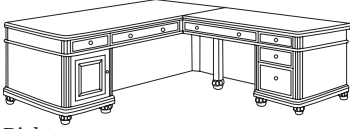
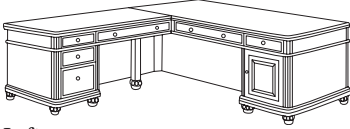
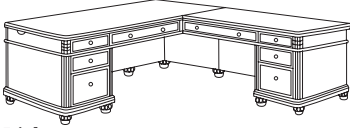
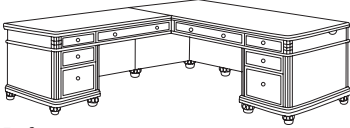

DMI COLLECTION

Item Description		W"	D"	H"	Weight	Cubic	List	Features
Model Number					Lbs.	Ft.	Price	
	Executive Desk 7480-36	72	36	30	307	61.8	\$ 2981.00	<ul style="list-style-type: none"> Felt-lined center drawer with wood pencil tray Felt-lined box drawer / box drawer with adjustable wood dividers / file drawer per pedestal Bottom box and file drawer lock in each pedestal
	Executive Desk 7480-34A	67.25	32.25	30	252	38.6	\$ 2232.00	<ul style="list-style-type: none"> Felt-lined center drawer with pencil tray functions as a lap drawer Felt-lined box drawer with adjustable wood dividers / file drawer per pedestal Box and file drawer lock in each pedestal
	Kneehole Credenza 7480-21	72	24	30	263	44.3	\$ 2737.00	<ul style="list-style-type: none"> Center drop-front drawer functions as a lap drawer or a keyboard tray Felt-lined box drawer / box drawer with adjustable wood dividers / file drawer per pedestal Bottom box and file drawer lock in each pedestal
	Computer Credenza 7480-22	67.5	24.25	30	268	40.1	\$ 2145.00	<ul style="list-style-type: none"> Center drop-front keyboard drawer Two felt-lined box drawers Right CPU pedestal features three media storage drawers and a power manager Left pedestal features one adjustable shelf and a pull-out printer shelf
	Right Computer L Desk 7480-48A Consists of: -480 Left Single Pedestal Desk -489 Right Single Pedestal Return	66	76	30	390	76.4	\$ 3133.00	<ul style="list-style-type: none"> Center drop-front / pull-out keyboard tray on single pedestal desk Felt-lined box drawer / tower computer cabinet with pull-out CD storage rack in desk pedestal Felt-lined center drawer with wood pencil tray on return
Right	Left Computer L Desk 7480-49A Consists of: -490 Right Single Pedestal Desk -499 Left Single Pedestal Return	66	76	30	390	76.4	\$ 3133.00	<ul style="list-style-type: none"> Felt-lined box drawer / box drawer with adjustable wood dividers / file drawer in return pedestal Bottom box and file drawer lock in return pedestal Finished back
		66	76	30	390	76.4	\$ 3133.00	
Left								
	Right Executive L Desk 7480-55 Consists of: -570 Left Single Pedestal Desk -579 Right Single Pedestal Return	72	84	30	461	94.2	\$ 3987.00	<ul style="list-style-type: none"> Felt-lined center drawer with drop-front, finished wood pencil tray on single pedestal desk Drop-front lap / keyboard drawer with finished wood pencil tray on single pedestal return Felt-lined box drawer / box drawer with adjustable wood dividers / file drawer per pedestal Bottom box and file drawers lock
Right	Left Executive L Desk 7480-56 Consists of: -580 Left Single Pedestal Desk -589 Left Single Pedestal Return	72	84	30	461	94.2	\$ 3987.00	
		72	84	30	461	94.2	\$ 3987.00	
Left								

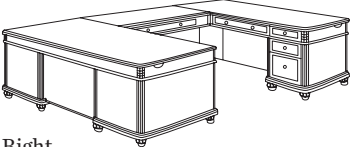
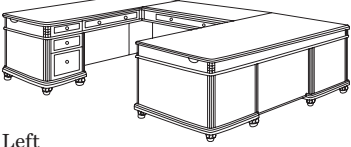
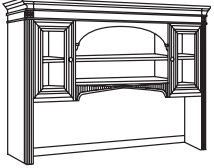
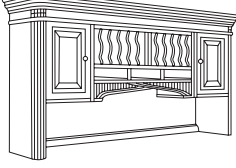

DMI COLLECTION

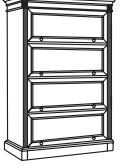
7480 West Indies Cherry Finish

	Item Description	W"	D"	H"	Weight Lbs.	Cubic Ft.	List Price	Features
	Right Executive U Desk 7480-57	72	108	30	568	116.1	\$ 4962.00	<ul style="list-style-type: none"> Felt-lined center drawer with drop-front, finished wood pencil tray on single pedestal desk Drop-front lap / keyboard drawer with finished wood pencil tray on single pedestal credenza Drop-front lap / keyboard drawer on bridge Felt-lined box drawer / box drawer with adjustable wood dividers / file drawer per pedestal Bottom box and file drawers lock
	Consists of:							
	-570 Left Single Pedestal Desk	72	36	30	281	62.2	\$ 2255.00	
	-571 Rt Single Pedestal Credenza	72	24	30	221	44.3	\$ 2062.00	
	-59 U Bridge	48	24	30	66	9.6	\$ 645.00	
Right								
	Left Executive U Desk 7480-58	72	108	30	568	116.1	\$ 4962.00	<ul style="list-style-type: none"> Felt-lined center drawer with drop-front, finished wood pencil tray on single pedestal desk Drop-front lap / keyboard drawer with finished wood pencil tray on single pedestal credenza Drop-front lap / keyboard drawer on bridge Felt-lined box drawer / box drawer with adjustable wood dividers / file drawer per pedestal Bottom box and file drawers lock
	Consists of:							
	-580 Right Single Pedestal Desk	72	36	30	281	62.2	\$ 2255.00	
	-581 Left Single Pedestal Credenza	72	24	30	221	44.3	\$ 2062.00	
	-59 U Bridge	48	24	30	66	9.6	\$ 645.00	
Left								
	Palladium Overhead Storage 7480-62	73	15	48	168	46.1	\$ 2337.00	<ul style="list-style-type: none"> Two cabinets with framed beveled glass fronts and each cabinet has a canister light and an adjustable glass shelf Center section has a canister light, one adjustable shelf and one fixed shelf Task light -62 for use with -21, -571, -581 -46 for use with -22A, -480, -490
	7480-46	69	15	46.5	160	39.4	\$ 1792.00	
	Governor's Overhead Storage 7480-44	69	15	46.5	160	40.3	\$ 1792.00	<ul style="list-style-type: none"> Two cabinets, each with an adjustable shelf Divided storage Task lighting Cable accessible 19.5" vertical clearance for monitor For use with -22A, -480, -490
	Lateral File 7480-16	36	21	30	150	20.1	\$ 1249.00	<ul style="list-style-type: none"> Two Lateral file drawers Single side lock Anti-tip device
	Computer Armoire 7480-75	55	23	62	345	53.7	\$ 3130.00	<ul style="list-style-type: none"> Deluxe two-tier pull-out keyboard / mouse tray 32.5 x 18 x 15.5 (25 H without shelf) monitor area CPU compartment with pull-out CD rack 19 x 18 x 9.25 (17.5 H without shelf) printer / scanner area Storage cabinet with an adjustable shelf Two box drawers and one file drawer
	Four Door Barrister Bookcase 7480-06	42	16	72	215	42.9	\$ 1933.00	
	Lateral File Bookcase 7480-08	39.5	19	78	191	44.3	\$ 2643.00	<ul style="list-style-type: none"> One file drawer will accommodate letter or legal hanging files Three adjustable shelves Canister light Semi-finished top allows for additional storage









Antigua VENEER COLLECTION

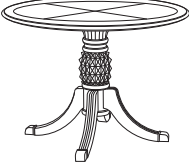

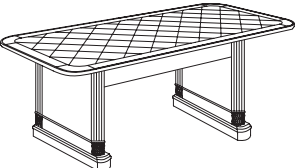
FLEXSTEEL®
CONTRACT

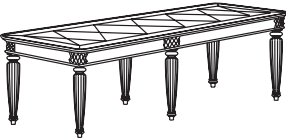
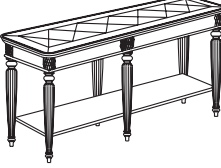
7480 West Indies Cherry Finish

DMI COLLECTION

Item Description	Model Number	W"	D"	H"	Weight Lbs.	Cubic Ft.	List		
							Price	Features	
	42" Round Conference Table 7480-89	42	42	30	110	14.7	\$	945.00	
	Consists of:								
	-011 Top	42	42		59	7.9	\$	565.00	
	-002 Pedestal Base				51	6.8	\$	380.00	
	48" Round Conference Table 7480-90	48	48	30	120	15.1	\$	1080.00	
	Consists of:								
	-016 Top	48	48		69	8.3	\$	700.00	
	-002 Pedestal Base				51	6.8	\$	380.00	
	8' Conference Table 7480-96	96	44	30	222	26.3	\$	2260.00	
	Consists of:								
	-005 Top	96	44		148	19.1	\$	1773.00	
	-001 Slab End Bases (set)				74	7.2	\$	887.00	
	End Table 7480-10	24	24	20	31	3.4	\$	613.00	<ul style="list-style-type: none"> • Construction of veneer on MDF with wood legs • Minor assembly required
	Coffee Table 7480-40	50	24	17	51	6.2	\$	698.00	<ul style="list-style-type: none"> • Construction of veneer on MDF with wood legs • Minor assembly required
	Sofa/Console Table 7480-82	60	16.75	30	80	29.4	\$	836.00	<ul style="list-style-type: none"> • Construction of veneer on MDF with wood legs • Minor assembly required
	Swan Executive High Back Chair with Upholstered Arms 7480-835	28.75	29.75	41.5-44.5	74	17.4	\$	1089.00	<ul style="list-style-type: none"> • Black leather upholstery • Gas lift • Swivel tilt mechanism • Five star hooded caster base • Seat width: 20.5" • Seat depth: 19.5" • Seat height: 20.5-23.5"
	Swan Executive High Back Chair with Wood/Upholstered Arms 7480-836	28.75	29.75	40.5-43.75	74	17.4	\$	1089.00	<ul style="list-style-type: none"> • Black leather upholstery • Gas lift • Swivel tilt mechanism • Five star hooded caster base • Seat width: 19.25" • Seat depth: 20" • Seat height: 20-24"
	Swan High Back Guest Chair 7480-821	27.5	28	41	55	21.6	\$	1015.00	<ul style="list-style-type: none"> • Black leather upholstery • Seat width: 17-19.5" • Seat depth: 18" • Seat height: 19"



Balmoor

VENEER COLLECTION

7688 Bordeaux Cherry Finish

Ageless refinement in a vintage design.

With European influences and neoclassical styling, the Balmoor Collection has the look of a family heirloom and the feel of brand-new wooden construction. Intricate details include fancy lace veneers, serpentine tops, exquisite detail in acanthus leaf accents and edge gardooning, all in a rich Bordeaux Cherry finish.

Details:

- Constructed on mahogany veneers, wood and wood products
- Construction feature mortise and tenon construction with wood cleats, glue, screws, staples, and threaded inserts with bolts
- Fluted pilasters feature acanthus leaf accents
- Tops are constructed of Marquetry mahogany veneers with wood substraight and NC lacquer finish
- All drawers feature a 3-sided plywood construction with dovetail joints and sealed interiors and are suspended on metal, ball bearing slides
- Knee-hole locking drawers are all keyed the same. If you need specific items keyed differently, please contact your customer service representative
- Box drawers feature a 3/4 extension with a 75lb load bearing rating
- File drawers are fully extending with a 150lb load rating
- File drawers equipped with metal rods for letter or legal sized hanging files
- Adjustable floor levelers
- Desk, credenza overheads are cable accessible

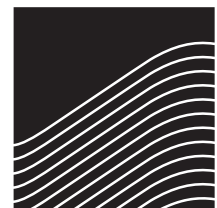

FLEXSTEEL®
CONTRACT

DMI COLLECTION



Balmoor VENEER COLLECTION



FLEXSTEEL®
CONTRACT

7688 Bordeaux Cherry Finish

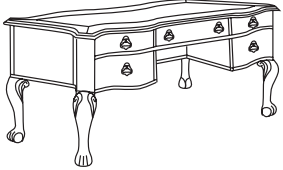

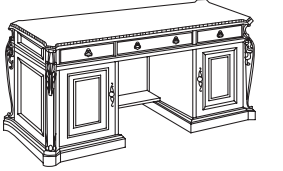
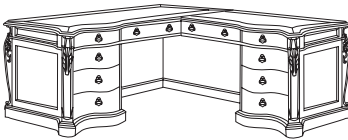
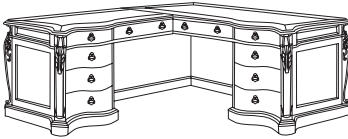
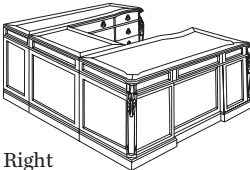
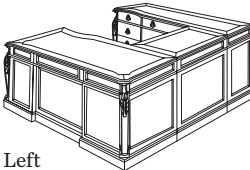
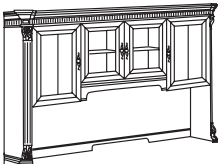



DMI COLLECTION

	Item Description	W"	D"	H"	Weight Lbs.	Cubic Ft.	List Price	Features
	Shaped Executive Desk							
	7688-36	72	36	30	355	61.0	\$ 3938.00	<ul style="list-style-type: none"> Center drawer / keyboard drawer with drop-front, pencil tray Felt-lined box drawer / box drawer with wood dividers / file drawer per pedestal Kneehole locking pedestals Power strip with 10' cord mounted to inside top of the modesty panel
7688-34	66	34	30	296	54.3	\$ 3475.00		
	Writing Desk							
	7688-88	72	36	30	272	60.6	\$ 2875.00	<ul style="list-style-type: none"> Center keyboard drawer with a drop-front permits use as a traditional center drawer or a keyboard drawer Center drawer is cable accessible Left pedestal has two box drawers with top box having felt lining and finished pencil tray
	Kneehole Credenza							
	7688-21	72	24	30	293	42.6	\$ 3028.00	<ul style="list-style-type: none"> Center keyboard drawer with drop-front Felt-lined box / box / file drawer per pedestal Power strip with 10' cord mounted to inside top of the modesty panel Kneehole locking pedestals
	Executive Computer Credenza							
	7688-22	72	24.75	30	300	45.5	\$ 2900.00	<ul style="list-style-type: none"> Drop-front, pull-out keyboard drawer with a power manager and storage shelf in back of kneehole Felt-lined drawer with wood pencil tray and a cabinet with a pull-out tray and a pull-out printer shelf in left pedestal Felt-lined drawer with pencil tray and a computer compartment in right pedestal
	Right Executive L Desk							
	7688-55	76	92	30	480	101.4	\$ 5830.00	<ul style="list-style-type: none"> Desk and return center drawer with pencil tray and drop front can function as a keyboard drawer Felt-lined box / box / file drawer per pedestal Kneehole locking pedestals Power strip with a 10' cord mounted to the inside top of the modesty panel on single pedestal desk Power manager in return
Consists of:								
	-570 Left Single Pedestal Desk	76	36	30	286	64.8	\$ 3269.00	
	-579 Right Single Pedestal Return	56	26.5	30	194	36.6	\$ 2561.00	
	Left Executive L Desk							
	7688-56	76	92	30	480	101.4	\$ 5830.00	
	Consists of:							
	-580 Right Single Pedestal Desk	76	36	30	286	64.8	\$ 3269.00	
	-589 Left Single Pedestal Return	56	26.5	30	194	36.6	\$ 2561.00	
Right								
Left								
	Right Executive U Desk							
	7688-57	76	112.5	30	553	118.1	\$ 6890.00	<ul style="list-style-type: none"> Desk and credenza center drawer with pencil tray and drop front can function as a keyboard drawer Felt-lined box / box / file drawer per pedestal Kneehole locking pedestals Power strip with a 10' cord mounted to the inside top of the modesty panel on single pedestal desk
Consists of:								
	-570 Left Single Pedestal Desk	76	36	30	286	64.8	\$ 3269.00	
	-571 Right Single Ped Credenza	75.25	26.5	30	194	47.7	\$ 2833.00	
	-59 U Bridge	50	25	30	73	5.6	\$ 788.00	
Right								
	Left Executive U Desk							
	7688-58	76	112.5	30	553	118.1	\$ 6890.00	
	Consists of:							
	-580 Right Single Pedestal Desk	76	36	30	286	64.8	\$ 3269.00	
	-581 Left Single Ped Credenza	75.25	26.5	30	194	47.7	\$ 2833.00	
	-59 U Bridge	50	25	30	73	5.6	\$ 788.00	
Left								
	Overhead Storage							
	7688-63	76.5	17	50	236	51.2	\$ 2346.00	<ul style="list-style-type: none"> Left and right cabinet each has one adjustable shelf Center cabinet has one glass adjustable shelf, canister light Task light 20" center vertical clearance for monitor For use with the -571, -581

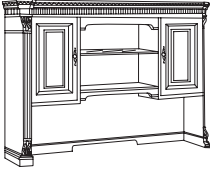

DMI COLLECTION

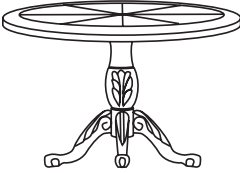
7688 Bordeaux Cherry Finish

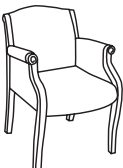
	Item Description Model Number	W"	D"	H"	Weight Lbs.	Cubic Ft.	List Price	Features
	Overhead Storage 7688-44	72	17.5	50	185	50.2	\$ 2201.00	<ul style="list-style-type: none"> • Two cabinets each with an adjustable shelf • Task lighting • Center adjustable wood framed glass shelf and a fixed shelf • Canister light • 20" center vertical clearance for monitor • For use with -21, -22
	Lateral File with Wood Top 7688-16	36	22	30	98	21.0	\$ 1854.00	<ul style="list-style-type: none"> • Two locking file drawers • Anti-tip device
	Lateral File with Marble Top 7688-17	36	22	30	138	21.0	\$ 2089.00	
	Open Bookcase 7688-08	42	17	76	202	43.6	\$ 2027.00	<ul style="list-style-type: none"> • Three adjustable shelves, of which two are glass and a fixed shelf • Canister light
	Double Bookcase 7688-108	60	17	76	285	66.9	\$ 2309.00	<ul style="list-style-type: none"> • Six adjustable shelves • Two fixed shelves • Two canister lights
	Double Bookcase with Cabinet 7688-109	60	17	76	352	69.1	\$ 3536.00	<ul style="list-style-type: none"> • Four adjustable shelves • Two cabinets, each with an adjustable shelf • Two canister lights
	Consists of: -091 Top	60	17	46	202	43.3	\$ 1415.00	
	-092 Base	58.25	16.25	30	150	25.8	\$ 2121.00	
	42" Round Conference Table 7688-89	42	42	30	89	7.4	\$ 1892.00	
	Consists of: -011 Top	42	42		65	4.9	\$ 1249.00	
	-002 Pedestal Base				24	2.8	\$ 643.00	
	48" Round Conference Table 7688-90	48	48	30	109	9.2	\$ 2044.00	
	Consists of: -016 Top	48	48		85	6.7	\$ 1401.00	
	-002 Pedestal Base				24	2.8	\$ 643.00	
	Hardley Roll Arm Executive Desk Chair in Black Leather 6940-1106	27	29.75	43-46.5	64	16.2	\$ 700.00	<ul style="list-style-type: none"> • Gas lift • Swivel tilt mechanism • Five star hooded caster base • 23" seat width • 19.5" seat depth • 19"-22.5" seat height
	Faraday Guest Chair 6855-2206	25	26	34	50	15.0	\$ 688.00	<ul style="list-style-type: none"> • Burgundy fabric cover • Seat width: 18.5" • Seat depth: 17" • Seat height: 17.75"



Keswick

VENEER COLLECTION

7990 English Cherry Finish

Handsome detailing on durable wooden construction.

Mirroring the looks of early American stateliness, the Keswick collection is a distinguished addition to any office. Solidly built with elegant moldings and a rich English Cherry finish, this group is a workplace staple you'll be able to count on for years to come.

Details:

- Construction consists of wood, wood veneers, and wood materials featuring solid wood bases, shaped mouldings and pilasters
- Cases feature mortise and tenon construction with wood cleats, glue, screws, staples and threaded inserts with bolts
- Tops constructed of veneer on wood and wood product
- HPL tops are straight grained
- Decorative veneer tops feature inlaid cherry veneers bordered by a walnut banding with a durable UV finish resistant to stains, mars and scratches
- All drawers feature 4-sided plywood construction with dovetail joints, stained and sealed interior, and are suspended on fully extending, metal, ball-bearing slides
- File drawers rated for 150 lbs; box drawers rated for 75 lbs
- File drawers equipped with metal rods for letter or legal sized hanging files
- Locking drawers are all keyed the same. If you need specific items keyed differently, please contact your customer service representative.
- Adjustable floor levelers

* Items within this collection marked with an asterisk are GSA items.



FLEXSTEEL®
CONTRACT

DMI COLLECTION



Keswick VENEER COLLECTION



FLEXSTEEL®
CONTRACT

7990 English Cherry Finish

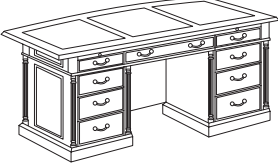
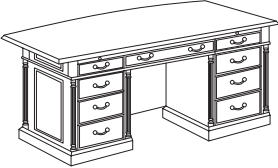
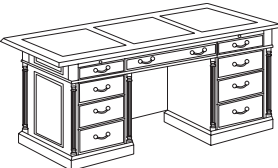
DMI COLLECTION

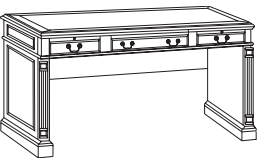
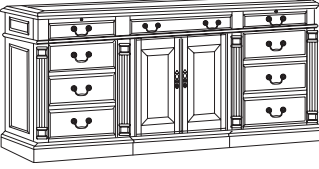
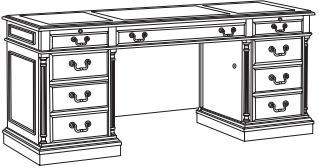
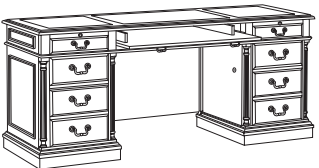
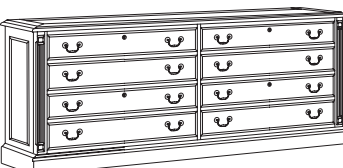
Item Description Model Number	W"	D"	H"	Weight Lbs.	Cubic Ft.	List Price	Features
 Executive Bow Front Desk 7990-36B	72	40	30	358	57.9	\$ 3500.00	<ul style="list-style-type: none"> • Pull-out writing board • Box / locking box / locking file drawer per pedestal • Center drawer with a double pencil tray
 Executive Bow Front Desk with HPL Top* 7990-36HPL*	72	40	30	358	57.9	\$ 3500.00	<ul style="list-style-type: none"> • Pull-out writing board • Box / locking box / locking file drawer per pedestal • Center drawer with a double pencil tray
 Executive Desk 7990-36	72	36	30	358	59.3	\$ 3171.00	<ul style="list-style-type: none"> • Pull-out writing board • Box / locking box / locking file drawer per pedestal • Center drawer with a double pencil tray
Executive Desk 7990-30	66	30	30	335	43.5	\$ 3003.00	
 Executive Desk with HPL Top* 7990-36HPL*	72	36	30	358	59.3	\$ 3171.00	<ul style="list-style-type: none"> • Pull-out writing board • Box / locking box / locking file drawer per pedestal • Center drawer with a double pencil tray
Executive Desk with HPL Top* 7990-30HPL*	66	30	30	335	43.5	\$ 3003.00	
 Table Desk 7990-88	72	36	30	320	60.1	\$ 2875.00	<ul style="list-style-type: none"> • Three drawers • Two pull-out writing boards
Table Desk with HPL Top* 7990-88HPL*	72	36	30	320	60.1	\$ 2875.00	
 Executive Credenza 7990-20	72	24	30	374	40.5	\$ 3179.00	<ul style="list-style-type: none"> • Center drawer with a drop-front • Cabinet with an adjustable shelf • Pull-out writing board / box / box / file drawer per pedestal • Bottom two drawers in each pedestal lock
Executive Credenza with HPL Top* 7990-20HPL*	72	24	30	374	40.5	\$ 3179.00	
 Executive Credenza 7990-21	72	24	30	298	41.4	\$ 3003.00	<ul style="list-style-type: none"> • Pull-out writing board • Box / locking box / locking file drawer per pedestal • Drop front, pull-out keyboard drawer • Wire management access provided
Executive Credenza with HPL Top* 7990-21HPL*	72	24	30	298	41.4	\$ 3003.00	
 Computer Credenza 7990-22	72	24	30	290	37.7	\$ 3003.00	<ul style="list-style-type: none"> • Pull-out writing board, box / locking box / locking file drawer in left pedestal • Pull-out writing board, box drawer and computer cabinet in the right pedestal • Cable management access provided • Drop front keyboard drawer
Computer Credenza with HPL Top* 7990-22HPL*	72	24	30	290	37.7	\$ 3003.00	
 Lateral File Credenza 7990-26	72	24	30	305	42.5	\$ 2301.00	<ul style="list-style-type: none"> • Four locking drawers that accommodate front-to-back letter sized and/or side-to-side legal sized files
Lateral File Credenza with HPL Top* 7990-26HPL*	72	24	30	305	42.5	\$ 2301.00	

* Items within this collection marked with an asterisk are GSA items.



DMI COLLECTION

7990 English Cherry Finish

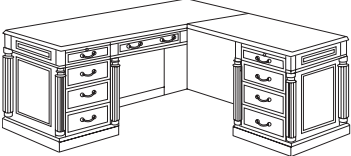
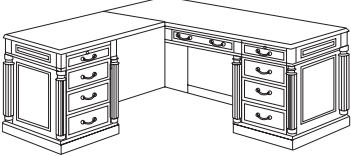
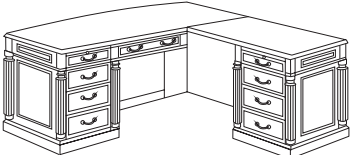
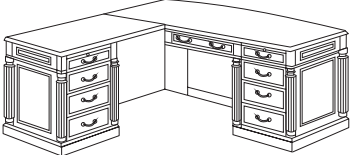
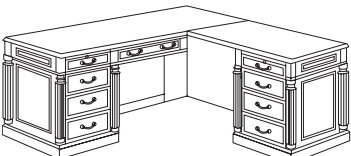
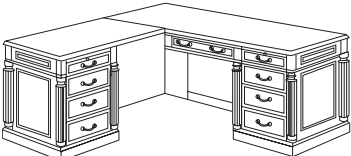
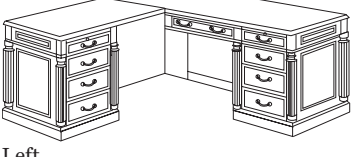
	Item Description	W"	D"	H"	Weight Lbs.	Cubic Ft.	List Price	Features
	Right Executive L Desk 7990-48	66	78	30	449	73.1	\$ 4368.00	<ul style="list-style-type: none"> • Pull-out writing board, box with finished wood pencil tray / locking box with dividers / locking file drawer per pedestal • Center drawer with a finished wood pencil tray on the single pedestal desk • Wire management access provided on the returns
	Consists of:							
	-470 Left Single Pedestal Desk	66	30	30	273	43.5	\$ 2358.00	
	-579 Right Single Pedestal Return	48	24	30	176	29.6	\$ 2010.00	
	Right Executive L Desk with HPL Top* 7990-48HPL*	66	78	30	449	73.1	\$ 4368.00	
	Left Executive L Desk 7990-49	66	78	30	449	73.1	\$ 4368.00	
	Consists of:							
	-480 Right Single Pedestal Desk	66	30	30	273	43.5	\$ 2358.00	
	-589 Left Single Pedestal Return	48	24	30	176	29.6	\$ 2010.00	
	Left Executive L Desk with HPL Top* 7990-49HPL*	66	78	30	449	73.1	\$ 4368.00	
	Right Bow Front Executive L Desk 7990-57B	72	88	30	483	87.5	\$ 5110.00	<ul style="list-style-type: none"> • Pull-out writing board, box / locking box / locking file drawer per pedestal • Center drawer with double pencil tray on single pedestal desk • Wire management access provided on the returns
	Consists of:							
	-570B Lt Bow Single Pedestal Desk	72	40	30	307	57.9	\$ 3100.00	
	-579 Right Single Pedestal Return	48	24	30	176	29.6	\$ 2010.00	
	Right Bow Front Executive L Desk with HPL Top* 7990-57BHPL*	72	88	30	483	87.5	\$ 5110.00	
	Left Bow Front Executive L Desk 7990-58B	72	88	30	483	87.5	\$ 5110.00	
	Consists of:							
	-580B Rt Bow Single Pedestal Desk	72	40	30	307	57.9	\$ 3100.00	
	-589 Left Single Pedestal Return	48	24	30	176	29.6	\$ 2010.00	
	Left Bow Front Executive L Desk with HPL Top* 7990-58BHPL*	72	88	30	483	87.5	\$ 5110.00	
	Right Executive L Desk 7990-57	72	84	30	483	88.9	\$ 4846.00	<ul style="list-style-type: none"> • Pull-out writing board, box / locking box / locking file drawer per pedestal • Center drawer with double pencil tray on single pedestal desk • Wire management access provided on the returns
	Consists of:							
	-570 Left Single Pedestal Desk	72	36	30	307	59.3	\$ 2836.00	
	-579 Right Single Pedestal Return	48	24	30	176	29.6	\$ 2010.00	
	Right Executive L Desk with HPL Top* 7990-57HPL*	72	84	30	483	88.9	\$ 4846.00	
	Left Executive L Desk 7990-58	72	84	30	483	88.9	\$ 4846.00	
	Consists of:							
	-580 Right Single Ped Desk	72	36	30	307	59.3	\$ 2836.00	
	-589 Left Single Pedestal Return	48	24	30	176	29.6	\$ 2010.00	
	Left Executive L Desk with HPL Top* 7990-58HPL*	72	84	30	483	88.9	\$ 4846.00	
	Left Executive L Desk 7990-58	72	84	30	483	88.9	\$ 4846.00	
	Consists of:							
	-580HPL Rt Single Ped Desk	72	36	30	307	59.3	\$ 2836.00	
	-589HPL Lt Single Pedestal Return	48	24	30	176	29.6	\$ 2010.00	
	Left Executive L Desk with HPL Top* 7990-58HPL*	72	84	30	483	88.9	\$ 4846.00	

* Items within this collection marked with an asterisk are GSA items.



7990 English Cherry Finish

DMI COLLECTION

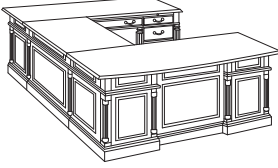
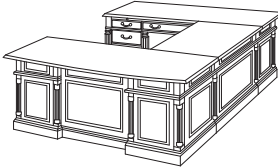
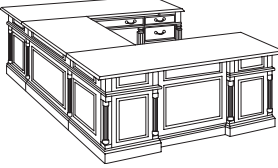
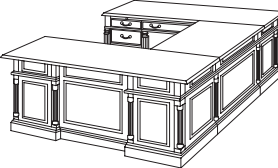
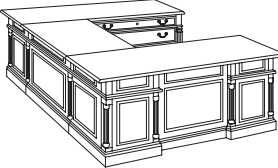
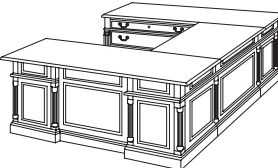
	Item Description	Weight	Cubic	List	
	Model Number	W" D" H"	Lbs.	Ft.	Price Features
 Right	Right Bow Front Executive U Desk				
	7990-37B	72 114 30	620	105.5	\$ 6182.00
	Consists of:				
	-570B Lt Bow Single Pedestal Desk	72 40 30	307	57.9	\$ 3100.00
	-577 Rt Single Pedestal Credenza	72 24 30	225	41.4	\$ 2092.00
	-59 U Bridge	50 24 30	88	6.2	\$ 990.00
	Right Bow Front Executive U Desk with HPL Top*				
	7990-37BHPL*	72 114 30	620	105.5	\$ 6182.00
	Consists of:				
	-570BHPL Lt Bow Single Ped Desk	72 40 30	307	57.9	\$ 3100.00
	-577HPL Rt Single Ped Credenza	72 24 30	225	41.4	\$ 2092.00
	-59HPL U Bridge	50 24 30	88	6.2	\$ 990.00
 Left	Left Bow Front Executive U Desk				
	7990-38B	72 114 30	620	105.5	\$ 6182.00
	Consists of:				
	-580B Right Bow Single Ped Desk	72 40 30	307	57.9	\$ 3100.00
	-588 Left Single Pedestal Credenza	72 24 30	225	41.4	\$ 2092.00
	-59 U Bridge	50 24 30	88	6.2	\$ 990.00
	Left Bow Front Executive U Desk with HPL Top*				
	7990-38BHPL*	72 114 30	620	105.5	\$ 6182.00
	Consists of:				
	-580BHPL Rt Bow Single Ped Desk	72 40 30	307	57.9	\$ 3100.00
	-588HPL Lt Single Ped Credenza	72 24 30	225	41.4	\$ 2092.00
	-59HPL U Bridge	50 24 30	88	6.2	\$ 990.00
 Right	Right Executive U Desk				
	7990-37	72 110 30	620	106.9	\$ 5918.00
	Consists of:				
	-570 Left Single Pedestal Desk	72 36 30	307	59.3	\$ 2836.00
	-577 Rt Single Pedestal Credenza	72 24 30	225	41.4	\$ 2092.00
	-59 U Bridge	50 24 30	88	6.2	\$ 990.00
	Right Executive U Desk with HPL Top*				
	7990-37HPL*	72 110 30	620	106.9	\$ 5918.00
	Consists of:				
	-570HPL Lt Single Pedestal Desk	72 36 30	307	59.3	\$ 2836.00
	-577HPL Rt Single Ped Credenza	72 24 30	225	41.4	\$ 2092.00
	-59HPL U Bridge	50 24 30	88	6.2	\$ 990.00
 Left	Left Executive U Desk				
	7990-38	72 110 30	620	106.9	\$ 5918.00
	Consists of:				
	-580 Right Single Pedestal Desk	72 36 30	307	59.3	\$ 2836.00
	-588 Lt Single Pedestal Credenza	72 24 30	225	41.4	\$ 2092.00
	-59 U Bridge	50 24 30	88	6.2	\$ 990.00
	Left Executive U Desk with HPL Top*				
	7990-38HPL*	72 110 30	620	106.9	\$ 5918.00
	Consists of:				
	-580HPL Rt Single Pedestal Desk	72 36 30	307	59.3	\$ 2836.00
	-588HPL Lt Single Ped Credenza	72 24 30	225	41.4	\$ 2092.00
	-59HPL U Bridge	50 24 30	88	6.2	\$ 990.00
 Right	Right Lateral File U Desk				
	7990-537	72 110 30	620	103.7	\$ 6618.00
	Consists of:				
	-570 Left Single Pedestal Desk	72 36 30	307	59.3	\$ 2836.00
	-547 Right Lateral File Credenza	72 24 30	225	38.2	\$ 2792.00
	-59 U Bridge	50 24 30	88	6.2	\$ 990.00
	Right Lateral File U Desk with HPL Top*				
	7990-537HPL*	72 110 30	620	103.7	\$ 6618.00
	Consists of:				
	-570HPL Lt Single Pedestal Desk	72 36 30	307	59.3	\$ 2836.00
	-547HPL Rt Lateral File Credenza	72 24 30	225	38.2	\$ 2792.00
	-59HPL U Bridge	50 24 30	88	6.2	\$ 990.00
 Left	Left Lateral File U Desk				
	7990-538	72 110 30	620	103.7	\$ 6618.00
	Consists of:				
	-580 Right Single Pedestal Desk	72 36 30	307	59.3	\$ 2836.00
	-548 Left Lateral File Credenza	72 24 30	225	38.2	\$ 2792.00
	-59 U Bridge	50 24 30	88	6.2	\$ 990.00
	Left Lateral File U Desk with HPL Top*				
	7990-538HPL*	72 110 30	620	103.7	\$ 6618.00
	Consists of:				
	-580HPL Rt Single Pedestal Desk	72 36 30	307	59.3	\$ 2836.00
	-548HPL Lt Lateral File Credenza	72 24 30	225	38.2	\$ 2792.00
	-59HPL U Bridge	50 24 30	88	6.2	\$ 990.00



* Items within this collection marked with an asterisk are GSA items.

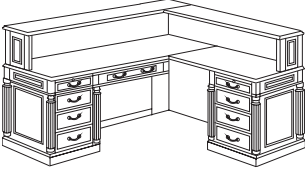
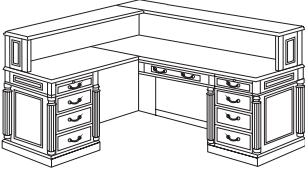
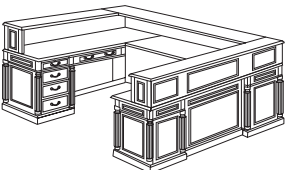
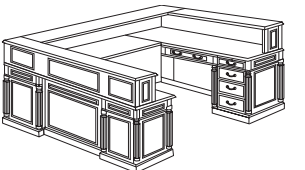

DMI COLLECTION

7990 English Cherry Finish

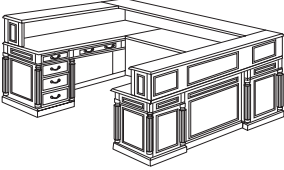
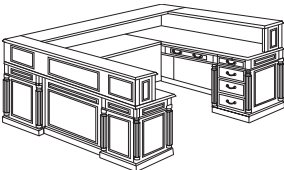
	Item Description	W"	D"	H"	Weight	Cubic	List	Features
	Model Number				Lbs.	Ft.	Price	
	Right Reception L Desk							
	7990-66	72	84	44	595	114.9	\$ 6313.00	• Pull-out writing board, box drawer with finished wood pencil tray / locking box with dividers / locking file drawer per pedestal
	Consists of:							• Center drawer with a finished wood pencil tray on single ped desk
	-507 Left Single Pedestal Desk	72	36	30	311	61.1	\$ 2836.00	• Wire management access provided on the returns
	-579 Right Single Pedestal Return	48	24	30	176	29.6	\$ 2010.00	
	-524 Desk Riser	71.5	12	14	55	12.1	\$ 812.00	
	-525 Return Riser	72	12	14	53	12.1	\$ 655.00	
	Right Reception L Desk with HPL Top*							
	7990-66HPL*	72	84	44	595	114.9	\$ 6313.00	
	Consists of:							
	-507HPL Lt Single Ped Desk	72	36	30	311	61.1	\$ 2836.00	
	-579HPL Rt Single Pedestal Return	48	24	30	176	29.6	\$ 2010.00	
	-524HPL Desk Riser	71.5	12	14	55	12.1	\$ 812.00	
	-525HPL Return Riser	72	12	14	53	12.1	\$ 655.00	
	Left Reception L Desk							
	7990-67	72	84	44	595	114.9	\$ 6313.00	
	Consists of:							
	-508 Right Single Ped Desk	72	36	30	311	61.1	\$ 2836.00	
	-589 Left Single Pedestal Return	48	24	30	176	29.6	\$ 2010.00	
	-526 Desk Riser	71.5	12	14	55	12.1	\$ 812.00	
	-527 Return Riser	72	12	14	53	12.1	\$ 655.00	
	Left Reception L Desk with HPL Top*							
	7990-67HPL*	72	84	44	595	114.9	\$ 6313.00	
	Consists of:							
	-508HPL Rt Single Ped Desk	72	36	30	311	61.1	\$ 2836.00	
	-589HPL Lt Single Pedestal Return	48	24	30	176	29.6	\$ 2010.00	
	-526HPL Desk Riser	71.5	12	14	55	12.1	\$ 812.00	
	-527HPL Return Riser	72	12	14	53	12.1	\$ 655.00	

	Right Reception U Desk							
	7990-68	72	110	44	775	137.1	\$ 7983.00	• Pull-out writing board, box drawer with finished wood pencil tray / locking box with dividers / locking file drawer per pedestal
	Consists of:							• Center drawer with a finished wood pencil tray on single ped desk
	-507 Left Single Pedestal Desk	72	36	30	311	61.1	\$ 2836.00	• Drop-front / pull-out keyboard tray on the credenza
	-577 Rt Single Pedestal Credenza	72	24	30	225	41.4	\$ 2092.00	• Wire management access through center drawer on the credenza
	-59 U Bridge	50	24	30	88	6.2	\$ 990.00	
	-521 Desk Riser	71.5	12	14	53	12.1	\$ 812.00	
	-522 Return Riser	71.5	12	14	53	12.1	\$ 812.00	
	-523 U Bridge Riser	85.5	12	14	45	4.2	\$ 441.00	
	Right Reception U Desk with HPL Top*							
	7990-68HPL*	72	110	44	775	137.1	\$ 7983.00	
	Consists of:							
	-507HPL Lt Single Pedestal Desk	72	36	30	311	61.1	\$ 2836.00	
	-577HPL Rt Single Ped Credenza	72	24	30	225	41.4	\$ 2092.00	
	-59HPL U Bridge	50	24	30	88	6.2	\$ 990.00	
	-521HPL Desk Riser	71.5	12	14	53	12.1	\$ 812.00	
	-522HPL Return Riser	71.5	12	14	53	12.1	\$ 812.00	
	-523HPL U Bridge Riser	85.5	12	14	45	4.2	\$ 441.00	
	Left Reception U Desk							
	7990-69	72	110	44	775	137.1	\$ 7983.00	
	Consists of:							
	-508 Right Single Pedestal Desk	72	36	30	311	61.1	\$ 2836.00	
	-588 Lt Single Pedestal Credenza	72	24	30	225	41.4	\$ 2092.00	
	-59 U Bridge	50	24	30	88	6.2	\$ 990.00	
	-521 Desk Riser	71.5	12	14	53	12.1	\$ 812.00	
	-522 Return Riser	71.5	12	14	53	12.1	\$ 812.00	
	-523 U Bridge Riser	85.5	12	14	45	4.2	\$ 441.00	
	Left Reception U Desk with HPL Top*							
	7990-69HPL*	72	110	44	775	137.1	\$ 7983.00	
	Consists of:							
	-508HPL Rt Single Pedestal Desk	72	36	30	311	61.1	\$ 2836.00	
	-588HPL Lt Single Ped Credenza	72	24	30	225	41.4	\$ 2092.00	
	-59HPL U Bridge	50	24	30	88	6.2	\$ 990.00	
	-521HPL Desk Riser	71.5	12	14	53	12.1	\$ 812.00	
	-522HPL Return Riser	71.5	12	14	53	12.1	\$ 812.00	
	-523HPL U Bridge Riser	85.5	12	14	45	4.2	\$ 441.00	

* Items within this collection marked with an asterisk are GSA items.





Keswick VENEER COLLECTION

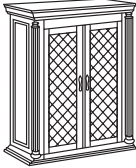

FLEXSTEEL®
CONTRACT

7990 English Cherry Finish

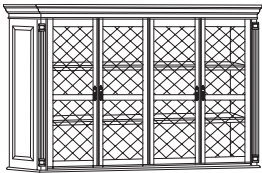
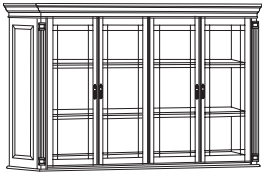
DMI COLLECTION

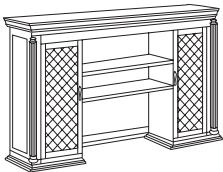
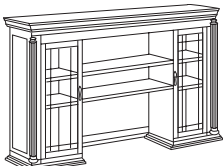





Item Description	Weight	Cubic	List	Features	
Model Number	W" D" H"	Lbs.	Ft.	Price	
 Organizer 7990-53	13 9 13	13	1.8	\$ 352.00	<ul style="list-style-type: none"> • Divided storage • For use with Reception Desk Risers • Can use horizontally or vertically
 Overhead Storage with Wire Mesh Doors 7990-41	36 15 50	113	22.7	\$ 2025.00	<ul style="list-style-type: none"> • Two adjustable shelves • For use with -14 or -16
 Overhead Storage with Leaded Glass Doors 7990-42	36 15 50	113	22.7	\$ 2025.00	<ul style="list-style-type: none"> • Two adjustable shelves • For use with -14 or -16
 Open Overhead Storage 7990-401	36 15 50	116	25.5	\$ 1355.00	<ul style="list-style-type: none"> • Two adjustable shelves • For use with -14 or -16
 Overhead Storage with Wire Mesh Doors 7990-463	71.75 16 50	258	47.7	\$ 2649.00	<ul style="list-style-type: none"> • Two two-door cabinets • Each cabinet has two adjustable shelves • For use with -20, -20HPL, -21, -21HPL, -22, -22HPL, -26, -26HPL, -577, -577HPL, -588, -588HPL
 Overhead Storage with Leaded Glass Doors 7990-464	71.75 16 50	254	47.7	\$ 2649.00	<ul style="list-style-type: none"> • Two two-door cabinets • Each cabinet has two adjustable shelves • For use with -20, -20HPL, -21, -21HPL, -22, -22HPL, -26, -26HPL, -577, -577HPL, -588, -588HPL
 Overhead Storage 7990-62	72 15 50	274	43.8	\$ 2382.00	<ul style="list-style-type: none"> • Two beveled glass door cabinets, each with two adjustable shelves • Center adjustable and fixed shelves • 19" vertical clearance for monitor • 18" task light; cable accessible • For use with -20, -20HPL, -21, -21HPL, -22, -22HPL, -26, -26HPL, -577, -577HPL, -588, -588HPL
 Executive Overhead Storage with Wire Mesh Doors 7990-63	72 15 50	226	42.2	\$ 2542.00	<ul style="list-style-type: none"> • Two cabinets, each with two adjustable shelves • Center fixed and adjustable shelves • One task and three accent lights • 19" vertical clearance for monitor • For use with -20, -20HPL, -21, -21HPL, -22, -22HPL, -26, -26HPL, -577, -577HPL, -588, -588HPL
 Executive Overhead Storage with Leaded Glass Doors 7990-64	72 15 50	232	45.0	\$ 2542.00	<ul style="list-style-type: none"> • Two cabinets, each with two adjustable shelves • Center fixed and adjustable shelves • One task and three accent lights • 19" vertical clearance for monitor • For use with -20, -20HPL, -21, -21HPL, -22, -22HPL, -26, -26HPL, -577, -577HPL, -588, -588HPL

* Items within this collection marked with an asterisk are GSA items.

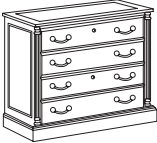
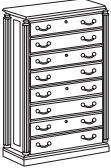
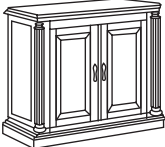

DMI COLLECTION

7990 English Cherry Finish

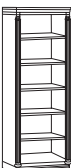
Item Description		W"	D"	H"	Weight	Cubic	List	Features
Model Number				Lbs.	Ft.	Price		
	Lateral File 7990-16	36	24	30	155	21.4	\$ 1667.00	<ul style="list-style-type: none"> • Two locking drawers • Equipped for letter sized front-to back and/or side-to-side hanging files or legal sized side-to-side hanging files • Equipped with an anti-tip device
	Lateral File with HPL Top* 7990-16HPL*	36	24	30	155	21.4	\$ 1667.00	
	Four Drawer Lateral File 7990-17	36	24	54	254	33.4	\$ 2625.00	<ul style="list-style-type: none"> • Four locking drawers that accommodate front-to-back letter sized and/or side-to-side legal sized files • Equipped with an anti-tip device
	Four Drawer Lateral File with HPL Top* 7990-17HPL*	36	24	54	254	33.4	\$ 2625.00	
	Executive Two-Door Cabinet 7990-14	36	24	30	112	20.1	\$ 1431.00	<ul style="list-style-type: none"> • Two-door cabinet with one adjustable shelf
	Executive Two-Door Cabinet with HPL Top* 7990-14HPL*	36	24	30	112	20.1	\$ 1431.00	
	Media Center Cabinet 7990-04	54	24	82	472	84.0	\$ 4696.00	<ul style="list-style-type: none"> • Top cabinet features a slide-out back panel, pocket doors, 42" x 21.25" x 36.25" compartment, cable ready harness with electrical outlet, and top located shelf • Bottom cabinet features two adjustable shelves • Cable accessible
	Consists of:							
	-041 Base				199	31.1	\$ 1682.00	
	-042 Top				273	52.9	\$ 3014.00	
 Right  Left	Right Hand Facing Single Door Wardrobe 7990-05	24	24	78	150	37.1	\$ 2037.00	<ul style="list-style-type: none"> • Removable hanger rod • One fixed and five adjustable shelves • -05 is hinged on right • -05LH is hinged on left
	Left Hand Facing Single Door Wardrobe 7990-05LH	24	24	78	150	37.1	\$ 2037.00	
	Double Door Wardrobe 7990-06	44	24	78	372	62.6	\$ 3450.00	<ul style="list-style-type: none"> • Hanger rod • Ten adjustable shelves
	Lateral File Storage Unit 7990-07	40	24	80	364	64.2	\$ 3701.00	<ul style="list-style-type: none"> • Cabinet with two adjustable shelves • Two locking lateral file drawers • Drawers are fully extending and equipped for letter and/or legal hanging files • Equipped with an anti-tip device
	Consists of:							
	-071 Base				166	23.7	\$ 2019.00	
	-072 Top				198	40.5	\$ 1682.00	
	Bookcase 7990-09	32	15	72	142	23.3	\$ 2169.00	<ul style="list-style-type: none"> • Two adjustable shelves on top • Two door cabinet below
	Center Open Bookcase 7990-108	32	16	80	135	34.6	\$ 1679.00	<ul style="list-style-type: none"> • Two fixed and four adjustable shelves

* Items within this collection marked with an asterisk are GSA items.







Keswick VENEER COLLECTION

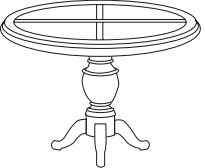
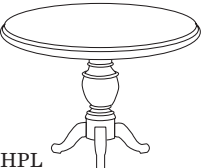

FLEXSTEEL®
CONTRACT

7990 English Cherry Finish

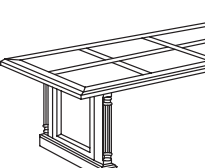
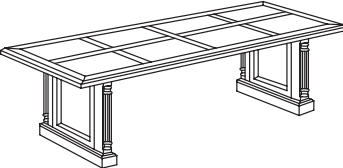
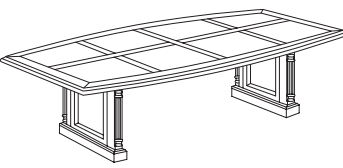
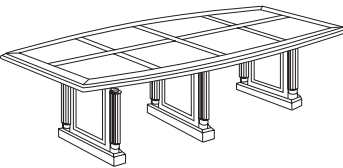
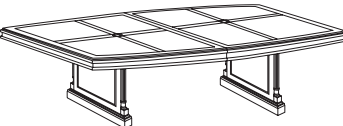
DMI COLLECTION

Item Description		W"	D"	H"	Weight	Cubic	List	Features
Model Number					Lbs.	Ft.	Price	
	Left Hand Facing Open Bookcase 7990-118	33.75	16	80	140	35.9	\$ 1679.00	• Two fixed and four adjustable shelves
	Right Hand Facing Open Bookcase 7990-128	33.75	16	80	140	35.9	\$ 1679.00	
	42" Round Queen Anne Conference Table 7990-89	42	42	30	78	20.3	\$ 1750.00	
	Consists of:							
	-011 Top				38	4.5	\$ 954.00	
	-002 Pedestal Base				40	15.8	\$ 796.00	
	42" Round Queen Anne Conference Table with HPL Top* 7990-89HPL*	42	42	30	78	20.3	\$ 1750.00	
	Consists of:							
	-011HPL Top				38	4.5	\$ 954.00	
	-002 Pedestal Base				40	15.8	\$ 796.00	
	48" Round Queen Anne Conference Table 7990-90	48	48	30	84	21.4	\$ 2226.00	
	Consists of:							
	-016 Top				44	5.6	\$ 1430.00	
	-002 Pedestal Base				40	15.8	\$ 796.00	
	48" Round Queen Anne Conference Table with HPL Top* 7990-90HPL*	48	48	30	84	21.4	\$ 2226.00	
	Consists of:							
	-016HPL Top				44	5.6	\$ 1430.00	
	-002 Pedestal Base				40	15.8	\$ 796.00	
	8' Rectangular Conference Table 7990-94	96	48	30	248	20.7	\$ 2860.00	
	Consists of:							
	-004 Top				155	13.9	\$ 1906.00	
	-007 Slab End Bases (set)				93	6.8	\$ 954.00	
	10' Boat Top Conference Table 7990-99	120	48	30	273	29.8	\$ 3975.00	
	Consists of:							
	-005 Top (2 pieces)				180	23.0	\$ 3021.00	
	-007 Slab End Bases (set)				93	6.8	\$ 954.00	
	12' Boat Top Conference Table 7990-97	144	48	30	391	40.2	\$ 4833.00	
	Consists of:							
	-006 Top (2 pieces)				255	26.5	\$ 3339.00	
	-007 Slab End Bases (set)				93	6.8	\$ 954.00	
	-008 Slab Center Base				43	6.9	\$ 540.00	
	8' Boat Shaped Expandable Conference Table 7990-96EX	96	48	30	300	20.1	\$ 3065.00	<ul style="list-style-type: none"> • Grommet in each top section • -017 optional storage base available • Grommets accommodate optional 0000-24, 0000-25 Mini Cove Power Center available
	Consists of:							
	-9031 Left & Right Tops	48	48		150	12.1	\$ 1882.00	
	-9033 Base (2 needed)	28	5.25	29	100	7.0	\$ 1010.00	
	-9034 Rail Set for 9031	52			50	1.0	\$ 173.00	
	10' Boat Shaped Expandable Conference Table 7990-120EX	120	48	30	330	23.4	\$ 3448.00	
	Consists of:							
	-9030 Left & Right Tops	60	48		180	15.0	\$ 2244.00	
	-9033 Base (2 needed)	28	5.25	29	100	7.0	\$ 1010.00	
	-9038 Rail Set for 10' table	76			50	1.0	\$ 194.00	

* Items within this collection marked with an asterisk are GSA items.



Item Description	W"	D"	H"	Weight Lbs.	Cubic Ft.	List Price	Features
8' Rectangular Expandable Conference Table 7990-96REX	96	48	30	300	20.1	\$ 2968.00	<ul style="list-style-type: none"> • Grommet in each top section • -017 optional storage base available • Grommets accommodate optional 0000-24, 0000-25 Mini Cove Power Center available
Consists of:							
-9028 Left & Right Tops	48	48		150	12.1	\$ 1785.00	
-9033 Base (2 needed)	28	5.25	29	100	7.0	\$ 1010.00	
-9034 Rail Set for 9028	52			50	1.0	\$ 173.00	
10' Rectangular Expandable Conference Table 7990-120REX	120	48	30	330	23.4	\$ 3295.00	
Consists of:							
-9029 Left & Right Tops	60	48		180	15.0	\$ 2091.00	
-9033 Base (2 needed)	28	5.25	29	100	7.0	\$ 1010.00	
-9038 Rail Set for 10' table	76			50	1.0	\$ 194.00	
12' Boat Shaped Expandable Conference Table 7990-144EX	144	48	30	475	35.7	\$ 4672.00	<ul style="list-style-type: none"> • Grommet in each top section • -017 optional storage base available • Grommets accommodate optional 0000-24, 0000-25 Mini Cove Power Center available
Consists of:							
-9031 Left & Right Tops	48	48		150	12.1	\$ 1882.00	
-9032 Center Top & Rails	48	48		75	10.7	\$ 969.00	
-9033 Base (3 needed)	28	5.25	29	150	10.5	\$ 1515.00	
-9035 Rail Set for 9031 (2 needed)	48			100	2.4	\$ 306.00	
14' Boat Shaped Expandable Conference Table 7990-168EX	168	48	30	505	39.0	\$ 5086.00	
Consists of:							
-9030 Left & Right Tops	60	48		180	15.0	\$ 2244.00	
-9032 Center Top & Rails	48	48		75	10.7	\$ 969.00	
-9033 Base (3 needed)	28	5.25	29	150	10.5	\$ 1515.00	
-9037 Rail Set for 9030 (2 needed)	60.5			100	2.8	\$ 358.00	
12' Rectangular Expandable Conference Table 7990-144REX	144	48	30	475	35.7	\$ 4575.00	<ul style="list-style-type: none"> • Grommet in each top section • -017 optional storage base available • Grommets accommodate optional 0000-24, 0000-25 Mini Cove Power Center available
Consists of:							
-9028 Left & Right Tops	48	48		150	12.1	\$ 1785.00	
-9032 Center Top & Rails	48	48		75	10.7	\$ 969.00	
-9033 Base (3 needed)	28	5.25	29	150	10.5	\$ 1515.00	
-9035 Rail Set for 9028 (2 needed)	48			100	2.4	\$ 306.00	
14' Rectangular Expandable Conference Table 7990-168REX	168	48	30	505	39.0	\$ 4933.00	
Consists of:							
-9029 Left & Right Tops	60	48		180	15.0	\$ 2091.00	
-9032 Center Top & Rails	48	48		75	10.7	\$ 969.00	
-9033 Base (3 needed)	28	5.25	29	150	10.5	\$ 1515.00	
-9037 Rail Set for 9029 (2 needed)	60.5			100	2.8	\$ 358.00	
16' Boat Shaped Expandable Conference Table 7990-192EX	192	48	30	600	49.9	\$ 6146.00	<ul style="list-style-type: none"> • Grommet in each top section • -017 optional storage base available • Grommets accommodate optional 0000-24, 0000-25 Mini Cove Power Center available
Consists of:							
-9031 Left & Right Tops	48	48		150	12.1	\$ 1882.00	
-9032 Center Top & Rails (2 needed)	48	48		150	21.4	\$ 1938.00	
-9033 Base (4 needed)	28	5.25	29	200	14.0	\$ 2020.00	
-9035 Rail Set for 9031 (2 needed)	48			100	2.4	\$ 306.00	
18' Boat Shaped Expandable Conference Table 7990-216EX	216	48	30	630	53.2	\$ 6560.00	
Consists of:							
-9030 Left & Right Tops	60	48		180	15.0	\$ 2244.00	
-9032 Center Top & Rails (2 needed)	48	48		150	21.4	\$ 1938.00	
-9033 Base (4 needed)	28	5.25	29	200	14.0	\$ 2020.00	
-9037 Rail Set for 9030 (2 needed)	60.5			100	2.8	\$ 358.00	

* Items within this collection marked with an asterisk are GSA items.



7990 English Cherry Finish

DMI COLLECTION





Item Description	Weight	Cubic	List	Features
Model Number	Lbs.	Ft.	Price	
16' Rectangular Expandable Conference Table				
7990-192REX	600	49.9	\$ 6049.00	<ul style="list-style-type: none"> • Grommet in each top section • -017 optional storage base available • Grommets accommodate optional 0000-24, 0000-25 Mini Cove Power Center available
Consists of:				
-9028 Left & Right Tops	150	12.1	\$ 1785.00	
-9032 Center Top & Rails (2 needed)	150	21.4	\$ 1938.00	
-9033 Base (4 needed)	200	14.0	\$ 2020.00	
-9035 Rail Set for 9028 (2 needed)	100	2.4	\$ 306.00	
18' Rectangular Expandable Conference Table				
7990-216REX	630	53.2	\$ 6407.00	
Consists of:				
-9029 Left & Right Tops	180	15.0	\$ 2091.00	
-9032 Center Top & Rails (2 needed)	150	21.4	\$ 1938.00	
-9033 Base (4 needed)	200	14.0	\$ 2020.00	
-9037 Rail Set for 9029 (2 needed)	100	2.8	\$ 358.00	
20' Boat Shaped Expandable Conference Table				
7990-240EX	725	64.1	\$ 7620.00	<ul style="list-style-type: none"> • Grommet in each top section • -017 optional storage base available • Grommets accommodate optional 0000-24, 0000-25 Mini Cove Power Center available
Consists of:				
-9031 Left & Right Tops	150	12.1	\$ 1882.00	
-9032 Center Top & Rails (3 needed)	225	32.1	\$ 2907.00	
-9033 Base (5 needed)	250	17.5	\$ 2525.00	
-9035 Rail Set for 9031 (2 needed)	100	2.4	\$ 306.00	
22' Boat Shaped Expandable Conference Table				
7990-264EX	755	67.4	\$ 8034.00	
Consists of:				
-9030 Left & Right Tops	180	15.0	\$ 2244.00	
-9032 Center Top & Rails (3 needed)	225	32.1	\$ 2907.00	
-9033 Base (5 needed)	250	17.5	\$ 2525.00	
-9037 Rail Set for 9030 (2 needed)	100	2.8	\$ 358.00	
20' Rectangular Expandable Conference Table				
7990-240REX	725	64.1	\$ 7523.00	<ul style="list-style-type: none"> • Grommet in each top section • -017 optional storage base available • Grommets accommodate optional 0000-24, 0000-25 Mini Cove Power Center available
Consists of:				
-9028 Left & Right Tops	150	12.1	\$ 1785.00	
-9032 Center Top & Rails (3 needed)	225	32.1	\$ 2907.00	
-9033 Base (5 needed)	250	17.5	\$ 2525.00	
-9035 Rail Set for 9028 (2 needed)	100	2.4	\$ 306.00	
22' Rectangular Expandable Conference Table				
7990-264REX	755	67.4	\$ 7881.00	
Consists of:				
-9029 Left & Right Tops	180	15.0	\$ 2091.00	
-9032 Center Top & Rails (3 needed)	225	32.1	\$ 2907.00	
-9033 Base (5 needed)	250	17.5	\$ 2525.00	
-9037 Rail Set for 9029 (2 needed)	100	2.8	\$ 358.00	
48" Left and Right Section Rectangular Expandable Conference Table Tops				
7990-9028	150	12.1	\$ 1785.00	<ul style="list-style-type: none"> • Individual component • Grommet in each top section • -9028 includes two 48" section tops • -9029 includes two 60" section tops • Grommets accommodate optional 0000-24, 0000-25 Mini Cove Power Center available
60" Left and Right Section Rectangular Expandable Conference Table Tops				
7990-9029	180	15.0	\$ 2091.00	
48" Left and Right Section Boat Shaped Expandable Conference Table Tops				
7990-9031	150	12.1	\$ 1882.00	<ul style="list-style-type: none"> • Individual component • Grommet in each top section • -9031 includes two 48" section tops • -9030 includes two 60" section tops • Grommets accommodate optional 0000-24, 0000-25 Mini Cove Power Center available
60" Left and Right Section Boat Shaped Expandable Conference Table Tops				
7990-9030	180	15.0	\$ 2244.00	
48" Center Section Expandable Conference Table Top with 44" Rails				
7990-9032	75	10.7	\$ 969.00	<ul style="list-style-type: none"> • Individual component • Grommet in top section • Grommet accommodates optional 0000-24, 0000-25 Mini Cove Power Center available

* Items within this collection marked with an asterisk are GSA items.

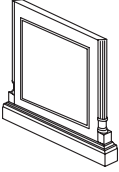
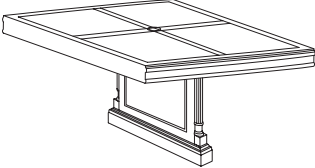
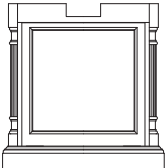
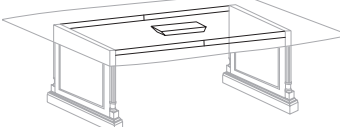

DMI COLLECTION

7990 English Cherry Finish

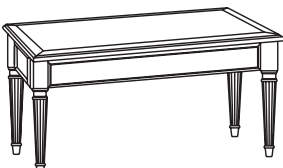
	Item Description	W"	D"	H"	Weight Lbs.	Cubic Ft.	List Price	Features
	Expandable Conference Table Base 7990-9033	28	5.25	29	50	3.5	\$ 505.00	<ul style="list-style-type: none"> • Individual component
	48" Center Section Top and Base 7990-903233 Consists of: -9032 Center Top & Rails -9033 Base	48	48	30	125	14.2	\$ 1474.00	<ul style="list-style-type: none"> • Grogmet in top • Grogmet accommodates optional 0000-24, 0000-25 Mini Cove Power Center available
	Expandable Conference Table Storage Base 7990-017	26.5	4.75	29.5	40	5.5	\$ 550.00	<ul style="list-style-type: none"> • Individual component • Hidden storage cabinet measures 22"W x 3.5"D x 20"H • Must be positioned at the end of the table • Cable accessible
	Expandable Conference Table Storage Base 7990-9034 7990-9035 7990-9037 7990-9038	52 60.5 60.5 76			50 50 50 50	1.0 1.2 1.4 1.4	\$ 173.00 \$ 153.00 \$ 179.00 \$ 194.00	<ul style="list-style-type: none"> • Individual components • -9034 rail set for 8' expandable tables • -9035 rail set for left and right 48" tops • -9037 rail set for left and right 60" tops • -9038 rail set for 10' expandable tables
	Buffet 7990-25B	66	24	36	200	46.3	\$ 3192.00	<ul style="list-style-type: none"> • Two, felt-lined fully extending drawers with one having a silverware holder • Two cabinets each with an adjustable shelf • Heavy duty locking casters • Optional 0000-40 Power Center (see Accessories section) is ideal when using a TV or other electronics with the buffet
	Buffet 7990-26B	38	24	36	175	27.6	\$ 2598.00	<ul style="list-style-type: none"> • Two, felt-lined fully extending drawers • Two-door cabinet with an adjustable shelf • Heavy duty locking casters • Optional 0000-40 Power Center (see Accessories section) is ideal when using a TV or other electronics with the buffet
	Presentation Board 7990-650	48	4.75	49	106	9.2	\$ 1483.00	<ul style="list-style-type: none"> • Open: 96" x 4.75" x 49" • Features marker board and tack boards on interior of each door
	End Table 7990-10	24	24	24	50	3.1	\$ 605.00	<ul style="list-style-type: none"> • Constructed of veneer on MDF with wood legs
	Coffee Table 7990-40	48	24	18	50	6.3	\$ 756.00	<ul style="list-style-type: none"> • Constructed of veneer on MDF with wood legs

* Items within this collection marked with an asterisk are GSA items.



Keswick VENEER COLLECTION



FLEXSTEEL®
CONTRACT

7990 English Cherry Finish

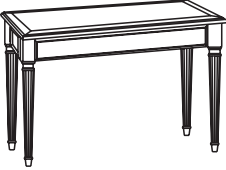
DMI COLLECTION

Item Description Model Number	W"	D"	H"	Weight Lbs.	Cubic Ft.	List Price	Features
 <p>Sofa/Console Table 7990-82</p>	48	18	28	70	4.7	\$ 756.00	<ul style="list-style-type: none"> • Constructed of veneer on MDF with wood legs
 <p>Hadley Roll Arm Executive Desk Chair in Black Leather 6940-1105</p>	27	29.75	43-46.5	64	16.2	\$ 700.00	<ul style="list-style-type: none"> • Gas lift • Swivel tilt mechanism • Five star hooded caster base • 23" seat width • 19.5" seat depth • 19"-22.5" seat height
 <p>Faraday Guest Chair 6855-2205</p>	25	26	34	50	15.0	\$ 688.00	<ul style="list-style-type: none"> • Burgundy fabric cover • Seat width: 18.5" • Seat depth: 17" • Seat height: 17.75"

* Items within this collection marked with an asterisk are GSA items.



Rue De Lyon

VENEER COLLECTION

7684 Ruby Cabernet Finish

Vibrant color pops against traditional styling.

Rue De Lyon blends old world styling with crisp lines and classic arches, bringing ageless style to home offices and small commercial environments. With stately veneers in a ruby cabernet finish, this collection's solid construction balances intricate hardwood trim and carved details.

Details:

- Constructed of maple solids, select hardwoods and cherry veneers on selected wood products
- Tops are constructed with Cherry veneers on wood product with an NC lacquer finish top coat
- All drawers feature a 3-sided plywood construction with dovetail joints and sealed interiors and are suspended on metal, ball bearing slides
- Locking drawers are all keyed the same. If you need specific items keyed differently, please contact your customer service representative
- Box drawers feature a 3/4 extension with a 75lb load bearing rating
- File drawers are fully extending with a 150lb load rating
- File drawers equipped with metal rods for letter or legal sized hanging files
- Kneehole locking pedestals
- Adjustable floor levelers
- Cable accessible desks, credenzas and overheads

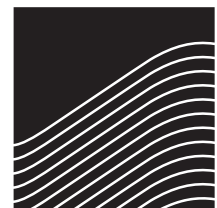

FLEXSTEEL®
CONTRACT

DMI COLLECTION



Rue De Lyon VENEER COLLECTION



FLEXSTEEL®
CONTRACT

7684 Ruby Cabernet Finish

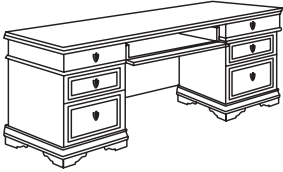

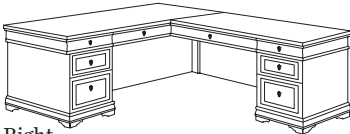
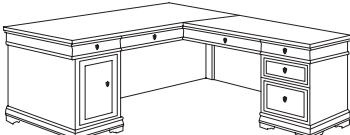
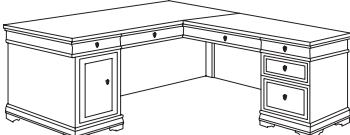

DMI COLLECTION

	Item Description Model Number	W"	D"	H"	Weight Lbs.	Cubic Ft.	List Price	Features
	Executive Desk 7684-36A 7684-34A	72 66	36 30	30 30	329 263	59.4 47.9	\$ 2641.00 \$ 2235.00	<ul style="list-style-type: none"> • Drop-front lap / keyboard drawer with removable pencil tray • Felt-lined box drawer with pencil tray / box drawer with removable dividers / file drawer per pedestal • Locking pedestals
	Kneehole Credenza 7684-21A	72	24	30	255	45.1	\$ 2210.00	<ul style="list-style-type: none"> • Center drop-front drawer with pencil tray can function as a lap drawer or keyboard tray • Felt-lined box drawer / locking box drawer with removable dividers / locking file drawer per pedestal
	Computer Credenza 7684-22A	66	24	30	248	41.8	\$ 2057.00	<ul style="list-style-type: none"> • Drop-front lap/keyboard drawer • Left pedestal features a felt-lined box drawer and a computer cabinet • Right pedestal features felt-lined box / box / locking file drawer • Cable accessible
	Right Executive L Desk 7684-55A Consists of: -570 Left Single Pedestal Desk -579 Right Single Pedestal Return	72 72 48	84 36 24	30 30 30	462 286 176	95.1 63.9 31.2	\$ 3396.00 \$ 2105.00 \$ 1291.00	<ul style="list-style-type: none"> • Drop-front lap / keyboard drawer with a removable pencil tray on both desks and returns • Felt-lined box drawer with a pencil tray / box with removable dividers / file drawer per pedestal • Bottom box and file drawer are locking • Grommet in each pedestal end
Right	Left Executive L Desk 7684-56A Consists of: -580 Right Single Pedestal Desk -589 Left Single Pedestal Return	72 72 48	84 36 24	30 30 30	462 286 176	95.1 63.9 31.2	\$ 3396.00 \$ 2105.00 \$ 1291.00	
	Right Computer L Desk 7684-48A Consists of: -480 Left Single Pedestal Desk -489 Right Single Pedestal Return	66 66 48	76 28 24	30 30 30	415 243 172	75.2 46.4 28.8	\$ 2807.00 \$ 1683.00 \$ 1124.00	<ul style="list-style-type: none"> • Drop-front, pull-out keyboard drawer on desk • Felt-lined box drawer with pencil tray / tower computer cabinet in desk pedestal • Lap drawer on return • Felt-lined box with pencil tray / box with removable dividers / locking file drawer in return pedestal • Finished on all sides
Right	Left Computer L Desk 7684-49A Consists of: -490 Right Single Pedestal Desk -499 Left Single Pedestal Return	66 66 48	76 28 24	30 30 30	415 243 172	75.2 46.4 28.8	\$ 2807.00 \$ 1683.00 \$ 1124.00	
	Right Computer L Desk 7684-53 Consists of: -480 Left Single Pedestal Desk -579 Right Single Pedestal Return	66 66 48	76 28 24	30 30 30	419 243 176	77.6 46.4 31.2	\$ 2974.00 \$ 1683.00 \$ 1291.00	<ul style="list-style-type: none"> • Drop-front, pull-out keyboard drawer on desk and return • Felt-lined box drawer with pencil tray / tower computer cabinet in desk pedestal • Felt-lined box drawer with a pencil tray / box with removable dividers / file drawer in return pedestal • Bottom box and file drawer are locking • Finished on all sides
Right	Left Computer L Desk 7684-54 Consists of: -490 Right Single Pedestal Desk -589 Left Single Pedestal Return	66 66 48	76 28 24	30 30 30	419 243 176	77.6 46.4 31.2	\$ 2974.00 \$ 1683.00 \$ 1291.00	

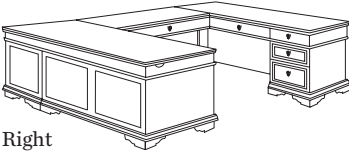
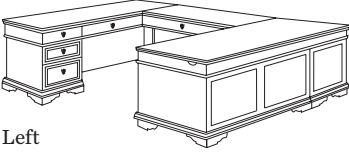
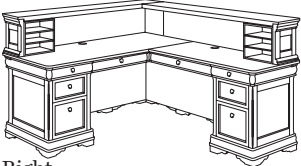

DMI COLLECTION

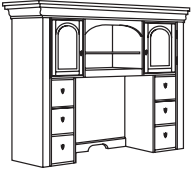
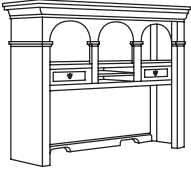
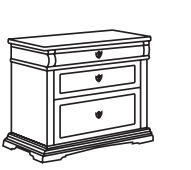
7684 Ruby Cabernet Finish

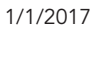
	Item Description	W"	D"	H"	Weight	Cubic	List	Features
	Model Number				Lbs.	Ft.	Price	
	Right Executive U Desk							
	7684-57A	72	108	30	569	113.6	\$ 4603.00	<ul style="list-style-type: none"> Drop-front lap / keyboard drawer with a removable pencil tray on both desks and credenzas Bridge has a drop-front lap / keyboard drawer Felt-lined box drawer with a pencil tray / box with removable dividers / file drawer per pedestal Bottom box and file drawer are locking Grommet in each pedestal end
	Consists of:							
	-570 Left Single Pedestal Desk	72	36	30	286	63.9	\$ 2105.00	
	-571 Rt Single Pedestal Credenza	72	24	30	198	39.4	\$ 1870.00	
	-59 U Bridge	48	24	30	85	10.3	\$ 628.00	
	Left Executive U Desk							
	7684-58A	72	108	30	569	113.6	\$ 4603.00	
	Consists of:							
	-580 Right Single Pedestal Desk	72	36	30	286	63.9	\$ 2105.00	
	-581 Left Single Pedestal Credenza	72	24	30	198	39.4	\$ 1870.00	
	-59 U Bridge	48	24	30	85	10.3	\$ 628.00	
	Right Reception L Desk							
	7684-68	66	78	44	550	84.0	\$ 4704.00	<ul style="list-style-type: none"> Cable accessible center drawer with a drop-front, pencil tray on desk and return Box with a pencil tray / box with removable dividers / file drawer in desk pedestal File / file drawer in return pedestal Desk & return tops are pre-drilled for reception decks Grommet in each pedestal end and on tops
	Consists of:							
	-380 Left Pedestal Reception Desk	66	30	30	250	46.3	\$ 2178.00	
	-279 Right F/F Pedestal Return	48	24	30	200	29.6	\$ 1582.00	
	-524 Left Desk Deck	66	12	14	50	4.3	\$ 472.00	
	-526 Right Return Deck	66	12	14	50	3.8	\$ 472.00	
	Left Reception L Desk							
	7684-69	66	78	44	550	84.0	\$ 4704.00	
	Consists of:							
	-390 Right Pedestal Reception Desk	66	30	30	250	46.3	\$ 2178.00	
	-289 Left F/F Pedestal Return	48	24	30	200	29.6	\$ 1582.00	
	-525 Right Desk Deck	66	12	14	50	4.3	\$ 472.00	
	-527 Left Return Deck	66	12	14	50	3.8	\$ 472.00	
	Executive Overhead Storage							
	7684-62	73	15.5	48.75	223	42.6	\$ 2108.00	<ul style="list-style-type: none"> Two cabinets, each with an adjustable shelf Center section with accent lighting and adjustable shelf Task lighting for work area Six storage drawers
	Curio Overhead Storage							
	7684-46	67	15.5	48	200	38.3	\$ 1757.00	<ul style="list-style-type: none"> 22.5" vertical clearance for monitor -62 for use with -21A, -571, -581, -570, -580 -46 for use with -22A, -480, -490 Cable accessible
	Overhead Storage							
	7684-44	67	15.5	48	160	38.6	\$ 1757.00	<ul style="list-style-type: none"> Two storage areas behind drop-front drawer fronts Two accent lights Task light 20" vertical clearance for monitor For use with -22A, -480, -490 Cable accessible
	Lateral File							
	7684-16	36	24	30	144	22.8	\$ 1055.00	<ul style="list-style-type: none"> Two lateral file drawers Anti-tip device Side located lock
	Four Door Barrister Bookcase							
	7684-06	42	15.75	71.5	205	36.3	\$ 2040.00	<ul style="list-style-type: none"> Four adjustable wood framed glass shelves
	Double Bookcase							
	7684-07	47	16	78	161	47.5	\$ 2007.00	<ul style="list-style-type: none"> Four adjustable wood framed glass shelves Two canister lights Equipped with furniture tipping restraint Shelf depth: 12.25" Shelves adjust in 2.25" increments





Rue De Lyon VENEER COLLECTION



FLEXSTEEL®
CONTRACT

7684 Ruby Cabernet Finish

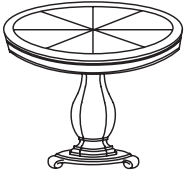
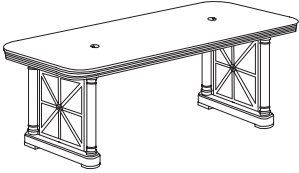
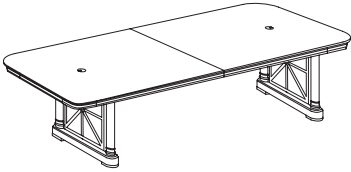
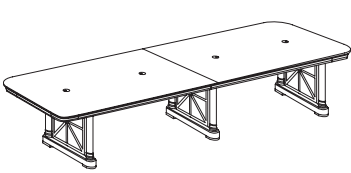
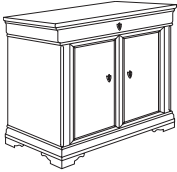

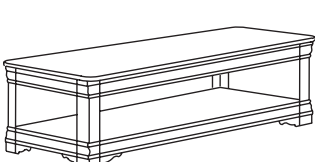



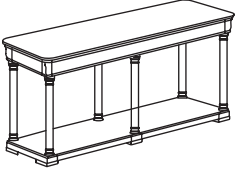

DMI COLLECTION

	Item Description	W"	D"	H"	Weight Lbs.	Cubic Ft.	List Price	Features
	File Bookcase 7684-08	39	18	78	176	44.0	\$ 1882.00	<ul style="list-style-type: none"> • Locking file drawer • Three adjustable wood framed glass shelves • Canister light • Equipped with furniture tipping restraint
	Computer Armoire 7684-150	54.25	23	60.25	323	54.3	\$ 2759.00	<ul style="list-style-type: none"> • Double door cabinet features a deluxe pull-out keyboard tray, two adjustable shelves, a pull-out printer tray, and a tower CPU compartment • Cabinet with an adjustable shelf • Felt-lined box drawer with pencil tray • Box drawer with adjustable wood dividers • Locking file drawer • Cable accessible
	42" Round Conference Table 7684-89	42	42	30	110	14.7	\$ 1394.00	
	Consists of:							
	-011 Top	42	42		59	7.9	\$ 902.00	
	-002 Pedestal Base				51	6.8	\$ 492.00	
	8' Rectangular Conference Table 7684-96A	96	44	30	218	27.4	\$ 2377.00	<ul style="list-style-type: none"> • Two grommets in top
	Consists of:							
	-005A Top	96	44		149	20.1	\$ 1586.00	
	-001A Slab End Bases (set)				69	7.3	\$ 791.00	
	10' Rectangular Conference Table 7684-120	120	44	30	324	25.1	\$ 2542.00	<ul style="list-style-type: none"> • Grommet in each top section
	Consists of:							
	-015 Top (2 pieces)	120	44	4.5	255	17.8	\$ 1751.00	
	-001A Slab End Bases (set)				69	7.3	\$ 791.00	
	12' Rectangular Conference Table 7684-144	144	44	30	436	33.2	\$ 3156.00	<ul style="list-style-type: none"> • Two grommets in each top section
	Consists of:							
	-006 Top (2 pieces)	144	44	4.5	335	21.1	\$ 1927.00	
	-001A Slab End Bases (set)				69	7.3	\$ 791.00	
	-007 Center Slab Base				32	4.8	\$ 438.00	
	Buffet 7684-26	38	24	36	203	26.0	\$ 1658.00	<ul style="list-style-type: none"> • One drawer with tableware tray • Two-door cabinet with two adjustable shelves • Four heavy duty casters • Optional 0000-40 Power Center (see Accessories section) is ideal when using a TV or other electronics with the buffet
	End Table 7684-10	24	24	20	45	4.9	\$ 458.00	<ul style="list-style-type: none"> • Construction of veneer on MDF with wood legs
	Coffee Table 7684-40	50	24	17	76	10.4	\$ 714.00	<ul style="list-style-type: none"> • Construction of veneer on MDF with wood legs



DMI COLLECTION

7684 Ruby Cabernet Finish

Item Description	W"	D"	H"	Weight	Cubic	List	Features
Model Number				Lbs.	Ft.	Price	
 <p>Sofa/Console Table 7684-82</p>	60	17	32	80	9.1	\$ 861.00	<ul style="list-style-type: none"> • Construction of veneer on MDF with wood legs
 <p>Rue De Lyon Task Chair 7684-861</p>	24.5	22.5	41.5-45.5	76	19.2	\$ 1038.00	<ul style="list-style-type: none"> • Black leather upholstery • Gas lift • Swivel tilt mechanism • Five star hooded caster base • Seat width: 19.25" • Seat depth: 21" • Seat height: 19.5-22.75"
 <p>Swan Executive High Back Chair with Upholstered Arms 7684-835</p>	28.75	29.75	41.5-44.5	74	17.4	\$ 1089.00	<ul style="list-style-type: none"> • Black leather upholstery • Gas lift • Swivel tilt mechanism • Five star hooded caster base • Seat width: 20.5" • Seat depth: 19.5" • Seat height: 20.5-23.5"
 <p>Swan Executive High Back Chair with Wood/Upholstered Arms 7684-836</p>	28.75	29.75	40.5-43.75	74	17.4	\$ 1089.00	<ul style="list-style-type: none"> • Black leather upholstery • Gas lift • Swivel tilt mechanism • Five star hooded caster base • Seat width: 19.25" • Seat depth: 20" • Seat height: 20-24"
 <p>Whittle Gooseneck Arm Desk Chair 7684-841</p>	24.5	24	41.5-45.5	70	18.7	\$ 1109.00	<ul style="list-style-type: none"> • Black leather upholstery • Gas lift • Swivel tilt mechanism • Five star hooded caster base • Seat width: 24.5" • Seat depth: 21.5" • Seat height: 20-24"
 <p>Rue De Lyon Guest Chair 7684-871</p>	24.5	22.5	43.5	49	17.2	\$ 981.00	<ul style="list-style-type: none"> • Black leather upholstery • Seat width: 19.25" • Seat depth: 21.25" • Seat height: 23"
 <p>Swan High Back Guest Chair 7684-821</p>	27.5	28	41	55	21.6	\$ 1015.00	<ul style="list-style-type: none"> • Black leather upholstery • Seat width: 17-19.5" • Seat depth: 18" • Seat height: 19"
 <p>Whittle Gooseneck Guest Chair 7684-851</p>	24.5	24	43.5	49	23.2	\$ 1003.00	<ul style="list-style-type: none"> • Black leather upholstery • Seat width: 21.75" • Seat depth: 20" • Seat height: 19"



Walden

VENEER COLLECTION

7859 Cocoa Cherry Finish

Clean lines with rich embellishments.

The Walden Collection brings a hint of old-world elegance to your office decor. Smooth molded surfaces play off intricate veneer details and reverse diamond matched veneer panels in a warm Cocoa Cherry finish.

Details:

- Construction consists of cherry veneers over hardwood solids and wood product and includes mortise and tenon, wood cleats, screws, staples and threaded inserts or bolts for strength and durability
- Top surfaces feature rounded corners, an NC lacquer finish to protect against marring and scratching, and a construction of cherry veneers on wood and wood product accented with walnut veneer inlay
- All drawers have a 4-sided construction with black drawer interiors
- Locking drawers are all keyed the same. If you need specific items keyed differently, please contact your customer service representative
- Box drawers feature a 3/4 extension with a 75lb load bearing rating
- File drawers are fully extending with a 150lb load rating
- File drawers equipped with metal rods for letter or legal sized hanging files
- Adjustable floor levelers
- Cable accessible in desks, credenas, and overheads



FLEXSTEEL®
CONTRACT

DMI COLLECTION







Walden VENEER COLLECTION



FLEXSTEEL®
CONTRACT

7859 Cocoa Cherry Finish

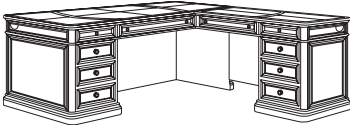
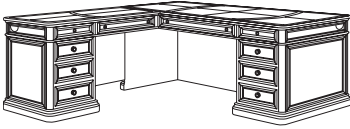
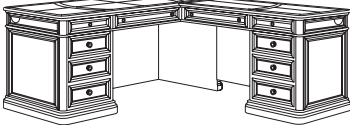
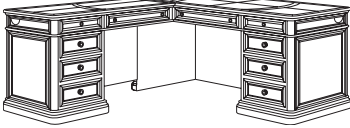



DMI COLLECTION

Item Description Model Number	W"	D"	H"	Weight Lbs.	Cubic Ft.	List Price	Features
 <p>Executive Curved Desk 7859-36</p>	72	36	30	318	62.8	\$ 2866.00	<ul style="list-style-type: none"> Center drawer with drop-front; double pencil tray Box/box/file per pedestal; middle drawers have removable dividers Bottom two drawers lock Grommet in each end panel
 <p>Junior Executive Desk 7859-30</p>	66	30	30	278	49.4	\$ 2542.00	<ul style="list-style-type: none"> Center drawer with drop-front; double pencil tray Box/box/file per pedestal; middle drawers have removable dividers Bottom two drawers lock Grommet in each end panel
 <p>Writing Desk 7859-88</p>	48	24	30	198	31.3	\$ 1433.00	<ul style="list-style-type: none"> Center keyboard drawer with drop-front, pencil tray Two utility drawers Grommet in top
 <p>Credenza 7859-21 7859-22</p>	72 66	24 24	30 30	286 282	44.3 40.8	\$ 2406.00 \$ 2190.00	<ul style="list-style-type: none"> Center drawer with drop-front; double pencil tray Box/box/file per pedestal; middle drawers have removable dividers Bottom two drawers lock Grommet in each end panel
 <p>Right Executive L Desk 7859-55 Consists of: -570 Left Single Pedestal Desk -579 Right Single Pedestal Return</p>	72 72 48	84 36 24	30 30 30	400 240 160	93.2 62.8 30.4	\$ 4267.00 \$ 2866.00 \$ 1401.00	<ul style="list-style-type: none"> Center drawer with drop-front; double pencil tray Box/box/file per pedestal; middle drawers have removable dividers Bottom two drawers lock Grommet in each end panel
 <p>Left Executive L Desk 7859-56 Consists of: -580 Right Single Pedestal Desk -589 Left Single Pedestal Return</p>	72 72 48	84 36 24	30 30 30	400 240 160	93.2 62.8 30.4	\$ 4267.00 \$ 2866.00 \$ 1401.00	
 <p>Right L Desk 7859-48 Consists of: -470 Left Single Pedestal Desk -579 Right Single Pedestal Return</p>	66 66 48	78 30 24	30 30 30	380 220 160	79.8 49.4 30.4	\$ 3727.00 \$ 2326.00 \$ 1401.00	<ul style="list-style-type: none"> Center drawer with drop-front; double pencil tray Box/box/file per pedestal; middle drawers have removable dividers Bottom two drawers lock Grommet in each end panel
 <p>Left L Desk 7859-49 Consists of: -480 Right Single Pedestal Desk -589 Left Single Pedestal Return</p>	66 66 48	78 30 24	30 30 30	380 220 160	79.8 49.4 30.4	\$ 3727.00 \$ 2326.00 \$ 1401.00	
 <p>Overhead Storage 7859-62 7859-44</p>	74 68	15.5 15.5	49 49	174 160	49.5 45.1	\$ 2109.00 \$ 1833.00	<ul style="list-style-type: none"> Two cabinets, each with an adjustable shelf One adjustable and one fixed center shelf Task light Cable accessible

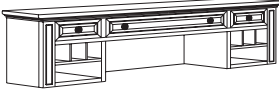
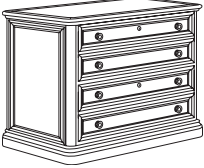
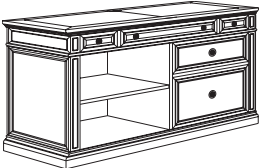

DMI COLLECTION

7859 Cocoa Cherry Finish

Item Description Model Number	W"	D"	H"	Weight Lbs.	Cubic Ft.	List Price	Features
 Desktop Storage 7859-153	48	12	14	64	8.4	\$ 703.00	<ul style="list-style-type: none"> • Three utility drawers • Pigeon-hole storage • Designed for use on -88, -164
 Lateral File 7859-16	36	24	30	123	23.5	\$ 1244.00	<ul style="list-style-type: none"> • Two independently locking drawers • Equipped with anti-tip device
 Printer/File Cabinet 7859-164	48	24	30	184	31.4	\$ 1785.00	<ul style="list-style-type: none"> • Cable accessible keyboard drawer with drop-front; double pencil tray • Two utility drawers; box drawer; file drawers • Open compartment with an adjustable shelf and cable access • Grommet in top
 Corner Table 7859-101	24	24	30	36	6.2	\$ 703.00	<ul style="list-style-type: none"> • Use with 24" deep cases to create corner configuration
 Whittle Gooseneck Arm Desk Chair 6000-841	24.5	24	41.5-45.5	70	18.7	\$ 1109.00	<ul style="list-style-type: none"> • Black leather upholstery • Gas lift • Swivel tilt mechanism • Five star hooded caster base • Seat width: 24.5" • Seat depth: 21.5" • Seat height: 20-24"
 Whittle Gooseneck Guest Chair 6000-851	24.5	24	43.5	49	23.2	\$ 1003.00	<ul style="list-style-type: none"> • Black leather upholstery • Seat width: 21.75" • Seat depth: 20" • Seat height: 19"



Governors

LAMINATE COLLECTION

7350 Engraved Executive Mahogany Finish

Traditional looks elevate a laminate design.

Bringing vintage details to economical materials, the Governors Collection is an elegant interpretation of laminate office furnishings. This traditionally-styled group features durable laminate tops with shaped moldings and engraved wood details in a glossy Executive Mahogany finish.

Details:

- Construction consists of wood, veneer and wood product with mortise and tenon, glued, stapled and screwed construction for maximum strength and durability
- High pressure laminate tops provide a durable work surface helping to reduce scuffs, stains, scratches and protection against moderate heat
- All drawers feature dovetail construction and are suspended on metal ball-bearing slides; MDF drawer fronts and edges
- Fully extending file drawers and 3/4 extending box drawers
- File drawers equipped with metal rods for letter or legal sized hanging files
- Locking drawers are all keyed the same. If you need specific items keyed differently, please contact your customer service representative.
- Adjustable floor levelers

* Items within this collection marked with an asterisk are GSA items.

1/1/2017 www.flexsteel.com

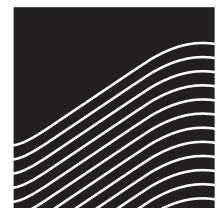

FLEXSTEEL®
CONTRACT

DMI COLLECTION

Governors LAMINATE COLLECTION



FLEXSTEEL®
CONTRACT

7350 Engraved Executive Mahogany Finish

DMI COLLECTION

	Item Description Model Number	W"	D"	H"	Weight Lbs.	Cubic Ft.	List Price	Features
	Executive Desk* 7350-36*	72	36	30	292	53.9	\$ 2091.00	<ul style="list-style-type: none"> • Pull-out writing board, box / file drawer per pedestal • Center drawer with central locking • 10" overhang for in-office conferencing
	Executive Desk* 7350-30*	60	30	30	248	38.3	\$ 2048.00	<ul style="list-style-type: none"> • Pull-out writing board, box / file drawer per pedestal • Center drawer with central locking
	Table Desk* 7350-88*	72	36	30	175	15.2	\$ 1562.00	<ul style="list-style-type: none"> • Center drawer with a pencil tray
	Executive Kneehole Credenza* 7350-24*	72	24	30	226	33.6	\$ 2091.00	<ul style="list-style-type: none"> • Box / file drawer per pedestal • Pull-out keyboard drawer • Fully finished back
	Kneehole Credenza* 7350-21*	66	20	30	174	27.0	\$ 1997.00	
	Tower CPU Computer Credenza* 7350-22*	66	20	30	177	27.0	\$ 1997.00	<ul style="list-style-type: none"> • Box / file drawer in left pedestal • Pull-out keyboard drawer • Tower CPU/storage compartment with a pull-out CD storage drawer and a power strip mounted in the right pedestal • Fully finished back
	Executive Storage Credenza* 7350-20*	66	20	30	193	27.0	\$ 1997.00	<ul style="list-style-type: none"> • Box / file drawer per pedestal • Storage compartment has one shelf • Fully finished back
	Right Executive L Desk* 7350-55*	72	84	30	400	77.0	\$ 3498.00	<ul style="list-style-type: none"> • Center drawer in single pedestal desk • Pull-out writing board above desk pedestal • Centrally locking box / file drawer pedestal in desk pedestal • Box / file drawer in return pedestal • Cable accessible return
	Consists of:							
	-570 Left Single Pedestal Desk	72	36	30	257	53.9	\$ 1988.00	
	-579 Right Single Pedestal Return	48	24	30	143	23.1	\$ 1510.00	
	Left Executive L Desk* 7350-56*	72	84	30	400	77.0	\$ 3498.00	
	Consists of:							
	-580 Right Single Ped Desk	72	36	30	257	53.9	\$ 1988.00	
	-589 Left Single Pedestal Return	48	24	30	143	23.1	\$ 1510.00	
	Right Executive L Desk* 7350-25*	72	78	30	393	74.9	\$ 3451.00	
	Consists of:							
	-570 Left Single Pedestal Desk	72	36	30	257	53.9	\$ 1988.00	
	-279 Right Single Pedestal Return	42	24	30	136	21.0	\$ 1463.00	
	Left Executive L Desk* 7350-26*	72	78	30	393	74.9	\$ 3451.00	
	Consists of:							
	-580 Right Single Ped Desk	72	36	30	257	53.9	\$ 1988.00	
	-289 Left Single Pedestal Return	42	24	30	136	21.0	\$ 1463.00	

* Items within this collection marked with an asterisk are GSA items.



DMI COLLECTION

7350 Engraved Executive Mahogany Finish

	Item Description Model Number	W"	D"	H"	Weight Lbs.	Cubic Ft.	List Price	Features
 Right	Right L Desk* 7350-48*	66	78	30	364	62.2	\$ 3432.00	<ul style="list-style-type: none"> Center drawer in single pedestal desk Pull-out writing board at top of desk pedestal Centrally locking box / file drawer pedestal in desk pedestal Box / file drawer in return pedestal Cable accessible return
	Consists of: -480 Left Single Pedestal Desk -579 Right Single Pedestal Return	66 48	30 24	30 30	221 143	39.1 23.1	\$ 1922.00 \$ 1510.00	
 Right	Left L Desk* 7350-49*	66	78	30	364	62.2	\$ 3432.00	
	Consists of: -490 Right Single Ped Desk -589 Left Single Pedestal Return	66 48	30 24	30 30	221 143	39.1 23.1	\$ 1922.00 \$ 1510.00	
 Left	Right L Desk* 7350-28*	66	72	30	357	60.1	\$ 3385.00	
	Consists of: -480 Left Single Pedestal Desk -279 Right Single Pedestal Return	66 42	30 24	30 30	221 136	39.1 21.0	\$ 1922.00 \$ 1463.00	
 Left	Left L Desk* 7350-29*	66	72	30	357	60.1	\$ 3385.00	
	Consists of: -490 Right Single Ped Desk -289 Left Single Pedestal Return	66 42	30 24	30 30	221 136	39.1 21.0	\$ 1922.00 \$ 1463.00	
 Right	Right Executive U Desk* 7350-737*	72	110	30	555	92.4	\$ 4547.00	<ul style="list-style-type: none"> Center drawer in single pedestal desk Pull-out writing board above desk pedestal Locking box / file drawer pedestal in desk pedestal; central locking via center drawer Box / file drawer in credenza pedestal Fully finished credenza back Cable accessible credenza and bridge
	Consists of: -570 Left Single Pedestal Desk -577 Right Single Ped Credenza -59 U Bridge	72 72 50	36 24 24	30 30 30	257 215 83	53.9 33.6 4.9	\$ 1988.00 \$ 1842.00 \$ 717.00	
 Left	Left Executive U Desk* 7350-738*	72	110	30	555	92.4	\$ 4547.00	
	Consists of: -580 Right Single Ped Desk -588 Left Single Pedestal Return -59 U Bridge	72 72 50	36 24 24	30 30 30	257 215 83	53.9 33.6 4.9	\$ 1988.00 \$ 1842.00 \$ 717.00	
 Left	Right U Desk* 7350-57*	72	107	30	517	90.3	\$ 4419.00	
	Consists of: -570 Left Single Pedestal Desk -571 Right Single Ped Credenza -59 U Bridge	72 72 50	36 21 24	30 30 30	257 177 83	53.9 31.5 4.9	\$ 1988.00 \$ 1714.00 \$ 717.00	
 Left	Left U Desk* 7350-58*	72	107	30	517	90.3	\$ 4419.00	
	Consists of: -580 Right Single Ped Desk -581 Left Single Pedestal Return -59 U Bridge	72 72 50	36 21 24	30 30 30	257 177 83	53.9 31.5 4.9	\$ 1988.00 \$ 1714.00 \$ 717.00	
 Right	Right Reception L Desk* 7350-655*	72	76	44	521	86.8	\$ 4919.00	<ul style="list-style-type: none"> Center drawer in single pedestal desk Pull-out writing board above desk pedestal Centrally locking box / file drawer pedestal in desk pedestal Box / file drawer in return pedestal Cable accessible return
	Consists of: -370 Left Single Pedestal Desk -579 Right Single Pedestal Return -531 Desk Riser -534 Return Riser	72 48 72 63.5	28 24 25.25 20.5	30 30 14 14	238 143 84 56	39.9 23.1 20.8 3.0	\$ 1988.00 \$ 1510.00 \$ 806.00 \$ 615.00	
 Left	Left Reception L Desk* 7350-656*	72	76	44	521	86.8	\$ 4919.00	
	Consists of: -380 Right Single Ped Desk -589 Left Single Pedestal Return -531 Desk Riser -534 Return Riser	72 48 72 63.5	28 24 25.25 20.5	30 30 14 14	238 143 84 56	39.9 23.1 20.8 3.0	\$ 1988.00 \$ 1510.00 \$ 806.00 \$ 615.00	

* Items within this collection marked with an asterisk are GSA items.



Governors LAMINATE COLLECTION



FLEXSTEEL®
CONTRACT

7350 Engraved Executive Mahogany Finish

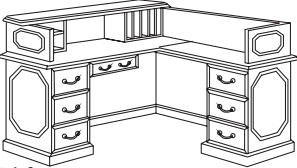
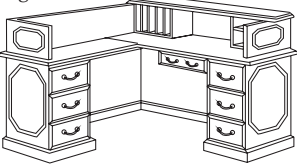
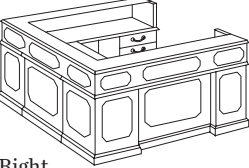
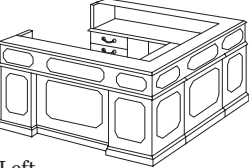
DMI COLLECTION

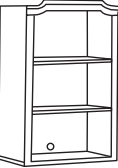
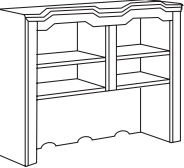
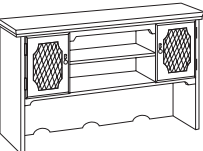



	Item Description	W"	D"	H"	Weight Lbs.	Cubic Ft.	List Price	Features
 Right	Right Reception L Desk* 7350-66*	66	78	44	461	80.7	\$ 4580.00	<ul style="list-style-type: none"> Center drawer in single pedestal desk Pull-out writing board above desk pedestal Centrally locking box / file drawer pedestal in desk pedestal Box / file drawer in return pedestal Cable accessible return
	Consists of:							
	-480 Left Single Pedestal Desk	66	30	30	221	39.1	\$ 1922.00	
	-579 Right Single Pedestal Return	48	24	30	143	23.1	\$ 1510.00	
	-601 Privacy Hutch	66	12	14	97	18.5	\$ 1148.00	
	48	12	13					
 Left	Left Reception L Desk* 7350-67*	66	78	44	461	80.7	\$ 4580.00	
	Consists of:							
	-490 Right Single Ped Desk	66	30	30	221	39.1	\$ 1922.00	
	-589 Left Single Pedestal Return	48	24	30	143	23.1	\$ 1510.00	
	-601 Privacy Hutch	66	12	14	97	18.5	\$ 1148.00	
	48	12	13					
 Right	Right Reception U Desk* 7350-657*	72	102	44	756	123.0	\$ 6820.00	<ul style="list-style-type: none"> Center drawer in single pedestal desk Pull-out writing board above desk pedestal Centrally locking box / file drawer pedestal in desk pedestal Box / file drawer in credenza pedestal Fully finished credenza back Cable accessible credenza and bridge
	Consists of:							
	-370 Left Single Pedestal Desk	72	28	30	238	39.9	\$ 1988.00	
	-577 Right Single Ped Credenza	72	24	30	215	33.6	\$ 1842.00	
	-59 U Bridge	50	24	30	83	4.9	\$ 717.00	
	-531 Desk Riser	72	25.25	14	84	20.8	\$ 806.00	
	72	20.5	14	84	20.8	\$ 806.00		
	76	12	14	52	3.0	\$ 661.00		
 Left	Left Reception U Desk* 7350-658*	72	102	44	756	123.0	\$ 6820.00	
	Consists of:							
	-380 Right Single Ped Desk	72	28	30	238	39.9	\$ 1988.00	
	-588 Left Single Pedestal Return	72	24	30	215	33.6	\$ 1842.00	
	-59 U Bridge	50	24	30	83	4.9	\$ 717.00	
	-531 Desk Riser	72	25.25	14	84	20.8	\$ 806.00	
	72	20.5	14	84	20.8	\$ 806.00		
	76	12	14	52	3.0	\$ 661.00		
	Organizer 7350-40	13	9.25	13	17	1.9	\$ 199.00	<ul style="list-style-type: none"> For use with the -531, -532, -534, -535 Features three fixed shelves / dividers Can be utilized horizontally or vertically
								
	Overhead Storage 7350-41	29	14	46	83	16.0	\$ 835.00	<ul style="list-style-type: none"> Two adjustable shelves Fits on top the lateral file, -152 Cable access grommet
	Overhead Storage 7350-61	66	14	46	155	33.4	\$ 1277.00	<ul style="list-style-type: none"> Two adjustable shelves Two stationary shelves 20" vertical clearance for monitor Cable accessible -61 fits atop the -571, -581, -517, -518, -527, -528, -24, -577 & -588 -44 fits atop the -20, -21 & -22
	7350-44	60	14	46	142	30.5	\$ 1165.00	
	Overhead Storage 7350-62	66	13	46	165	32.1	\$ 1778.00	<ul style="list-style-type: none"> 28.75" wide center, adjustable shelf Two door compartments with antique wire mesh fronts; each compartment with one adjustable shelf 20" vertical clearance for monitor Cable accessible -62 for use with -571, -581, -24, -577 & -588 -47 for use with -20, -21 & -22
	7350-47	60	13	46	157	28.9	\$ 1562.00	

* Items within this collection marked with an asterisk are GSA items.

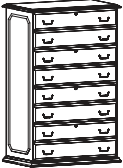
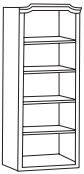
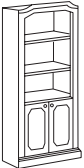

DMI COLLECTION

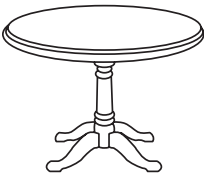
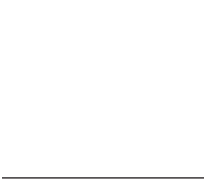
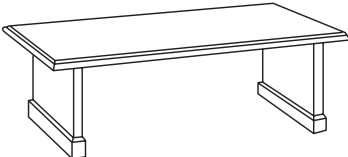
7350 Engraved Executive Mahogany Finish







	Item Description	W"	D"	H"	Weight Lbs.	Cubic Ft.	List Price	Features
	Lateral File*							
	7350-16*	36	24	30	152	20.3	\$ 1540.00	• Two locking drawers • Equipped with anti-tip device
	7350-152*	32	20	30	127	15.4	\$ 1288.00	
	Four Drawer Lateral File*							
	7350-17*	36	22	54	259	31.9	\$ 2328.00	• Four locking drawers • Equipped with anti-tip device
	Bookcase							
	7350-08	30	14	74	148	24.8	\$ 1165.00	• Three adjustable shelves and one stationary shelf
	Bookcase							
	7350-09	30	14	74	152	24.8	\$ 1277.00	• Two adjustable shelves • Abundant storage behind doors
	Bookcase							
	7350-172	32	16	72	147	29.3	\$ 1161.00	• -148 has three adjustable shelves • -160 has four adjustable shelves • -172 has five adjustable shelves
	7350-160	32	16	60	127	24.3	\$ 1074.00	
	7350-148	32	16	48	108	16.2	\$ 946.00	
	42" Round Queen Anne Conference Table*							• HPL top with solid wood veneer edges
	7350-89*	42	42	30	79	14.3	\$ 1240.00	
	Consists of:							
	-011 HPL Top	42	42		45	3.4	\$ 812.00	
-002 Pedestal Base				34	10.9	\$ 428.00		
	48" Round Queen Anne Conference Table*							
	7350-90*	48	48	30	96	15.2	\$ 1453.00	
	Consists of:							
	-016 HPL Top	48	48		62	4.3	\$ 1025.00	
-002 Pedestal Base				34	10.9	\$ 428.00		
	6' Rectangular Conference Table with Slab Bases*							• HPL top with solid wood veneer edges and slab bases
	7350-93*	72	36	30	165	11.7	\$ 1494.00	
	8' Rectangular Conference Table with Slab Bases*							
7350-94*	96	44	30	220	18.0	\$ 1758.00		
	10' Rectangular Conference Table with Slab Bases*							
	7350-95*	120	46	30	255	16.5	\$ 2454.00	
	Consists of:							
	-019 HPL Top (2 pieces)	120	46		175	11.2	\$ 2028.00	
	-001 Slab End Bases (set)				65	4.1	\$ 321.00	
-029 Apron Support Rails				15	1.2	\$ 105.00		

* Items within this collection marked with an asterisk are GSA items.

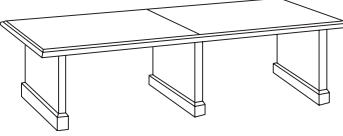
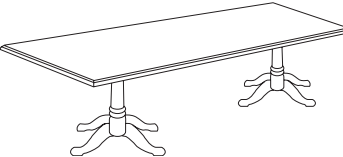

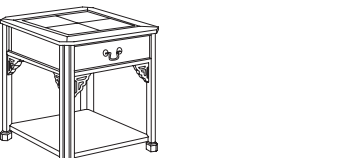
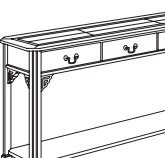
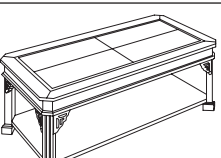
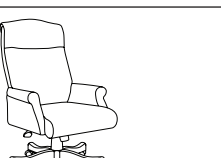
7350 Engraved Executive Mahogany Finish

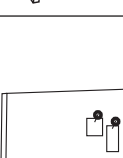
DMI COLLECTION

Item Description	W"	D"	H"	Weight Lbs.	Cubic Ft.	List Price	Features
12' Rectangular Conference Table with Slab Bases* 7350-99* Consists of: -006 HPL Top (2 pieces) -008 Center Slab Base -001 Slab End Bases (set)	144	46	30	438	32.4	\$ 4484.00	• HPL top with solid wood veneer edges and slab bases
							
6' Rectangular Conference Table with Queen Anne Base* 7350-96* Consists of: -017 HPL Top -002 Pedestal Base (2 needed)	72	36	30	153	29.1	\$ 2029.00	• HPL top with solid wood veneer edges
							
8' Rectangular Conference Table with Queen Anne Base* 7350-97* Consists of: -018 HPL Top -002 Pedestal Base (2 needed)	96	44	30	208	33.2	\$ 2244.00	
							
10' Rectangular Conference Table with Queen Anne Base* 7350-98* Consists of: -019 HPL Top (2 pieces) -002 Pedestal Base (2 needed)	120	46	30	243	33.0	\$ 2884.00	
							
Rectangular End Table 7350-81	26	21	22	31	4.1	\$ 559.00	• One drawer • Construction of veneer on MDF with wood legs
							
Rectangular Sofa Table 7350-82	53	16	27	66	5.1	\$ 673.00	• Three drawers • Construction of veneer on MDF with wood legs
							
Rectangular Cocktail Table 7350-84	48	24	16	44	5.5	\$ 673.00	• Construction of veneer on MDF with wood legs
							
Hadley Roll Arm Executive Desk Chair in Black Leather 6940-1101	27	29.75	43-46.5	64	16.2	\$ 700.00	• Gas lift • Swivel tilt mechanism • Five star hooded caster base • 23" seat width • 19.5" seat depth • 19"-22.5" seat height
							
Faraday Guest Chair 6855-2201	25	26	34	50	15.0	\$ 688.00	• Burgundy fabric cover • Seat width: 18.5" • Seat depth: 17" • Seat height: 17.75"
							
Cloth Tack Board 0000-320 0000-321	57 63	16.5 16.5		9 10	1.4 1.6	\$ 264.00 \$ 264.00	• -320 for use on -44 & -47 • -321 for use on -61 & -62
							

* Items within this collection marked with an asterisk are GSA items.



Belmont

VENEER COLLECTION

7130 Executive Cherry Finish / 7132 Brown Cherry Finish

Unpretentious yet smartly styled.

The Belmont Collection's transitional style brings refined warmth to any office, with solid construction to last through the years. New-world looks complement old-world touches like felt-lined box and center drawers, bow-front work surfaces and double beaded crown moldings, along with inlaid cherry veneer tops bordered by a rich walnut banding.

Details:

- Constructed of hardwoods, wood materials and cherry veneers with walnut veneer inlays on mortise and tenon construction with wood cleats, glue, staples and screws
- 7130 tops feature engineered cherry veneers and 7132 tops top feature cherry veneers, both tops are bordered by walnut banding and feathered cherry veneers
- Tops have a protective UV finish resistant to stains, mars and scratches
- Center drawers are felt-lined with a wood pencil tray
- Locking pedestals via knee space located locks
- All drawers suspended on fully extending, metal ball-bearing slides
- File drawers rated for 150 lbs; box drawers rated for 75 lbs;
- 4-sided plywood constructed drawers with dovetail joints; sealed and stained drawer interiors
- File drawers equipped with metal rods for letter or legal sized hanging files
- Adjustable floor levelers
- Cable accessible



FLEXSTEEL®
CONTRACT

DMI COLLECTION



Belmont VENEER COLLECTION



FLEXSTEEL®
CONTRACT

7130 Executive Cherry Finish / 7132 Brown Cherry Finish

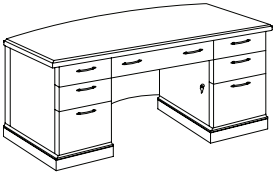
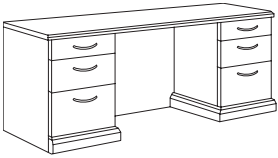
DMI COLLECTION

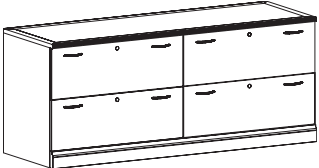
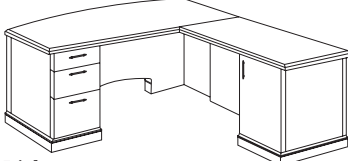
	Item Description Model Number	W"	D"	H"	Weight Lbs.	Cubic Ft.	List Price	Features
	Executive Bow Front Desk 713_-36	72	36	30	335	59.3	\$ 3097.00	<ul style="list-style-type: none"> • Box / box / file drawer per pedestal • Felt-lined center drawer with wood pencil tray • Radius shaped top
	Credenza 713_-21	72	24	30	310	41.4	\$ 2517.00	<ul style="list-style-type: none"> • Felt-lined box with wood pencil tray / box / file drawer per pedestal • Designed for use in wall unit applications
	Credenza with Full Return Base Mouldings 713_-23	71.75	24	30	305	41.4	\$ 2517.00	<ul style="list-style-type: none"> • Felt-lined box with wood pencil tray / box / file drawer per pedestal • Full return, base moulding
	Lateral File Credenza 713_-277	72	24	30	335	41.4	\$ 3053.00	<ul style="list-style-type: none"> • Four independently locking lateral file drawers
	Right Computer L Desk 713_-27	72	84	30	463	86.6	\$ 4645.00	<ul style="list-style-type: none"> • Felt-lined box / box / file drawer in desk pedestal • Ventilated computer storage cabinet with two media drawers and power manager in return pedestal
	Consists of:							
	-570 Left Single Pedestal Desk	72	36	30	287	59.3	\$ 2903.00	
	-379 Rt Sgl Computer Ped Return	48	24	30	176	27.3	\$ 1742.00	
Right	Left Computer L Desk 713_-28	72	84	30	463	86.6	\$ 4645.00	
	Consists of:							
	-580 Right Single Pedestal Desk	72	36	30	287	59.3	\$ 2903.00	
	-389 Lt Sgl Computer Ped Return	48	24	30	176	27.3	\$ 1742.00	
Left	Right Corner L Desk 713_-50	72	86.5	30	550	91.1	\$ 6525.00	<ul style="list-style-type: none"> • Felt-lined box / box / file drawer per pedestal
	Consists of:							
	-770 Left Corner Single Ped Desk	72	48	30	300	70.8	\$ 4677.00	
	-279 Right Single Pedestal Return	38.5	24	30	250	20.3	\$ 1848.00	
Right	Left Corner L Desk 713_-51	72	86.5	30	550	91.1	\$ 6525.00	
	Consists of:							
	-780 Right Corner Single Ped Desk	72	48	30	300	70.8	\$ 4677.00	
	-289 Left Single Pedestal Return	38.5	24	30	250	20.3	\$ 1848.00	
Left								



DMI COLLECTION

7130 Executive Cherry Finish / 7132 Brown Cherry Finish

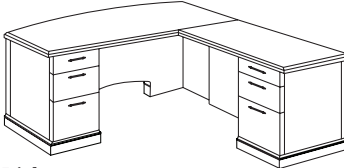
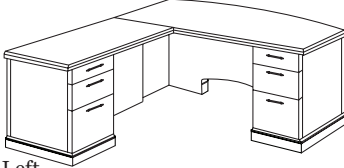
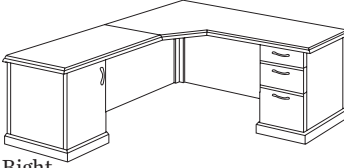
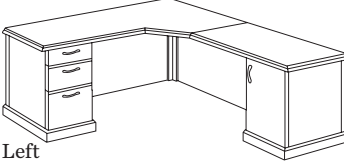
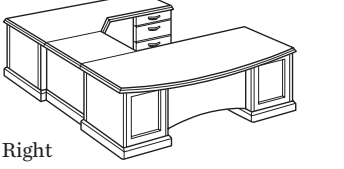
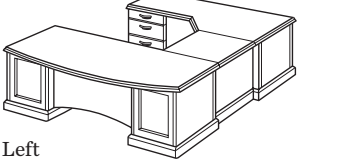
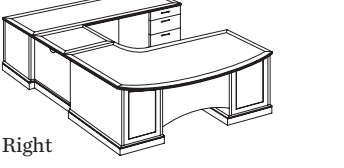
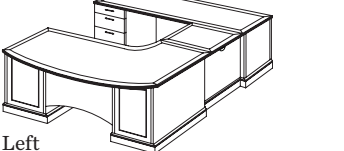
	Item Description	W"	D"	H"	Weight Lbs.	Cubic Ft.	List Price	Features
	Right Executive L Desk 713_-57	72	84	30	477	87.1	\$ 4645.00	• Felt-lined box / box / file drawer per pedestal
	Consists of: -570 Left Single Pedestal Desk -579 Right Single Pedestal Return	72 48	36 24	30 30	287 190	59.3 27.8	\$ 2903.00 \$ 1742.00	
Right	Left Executive L Desk 713_-58	72	84	30	477	87.1	\$ 4645.00	
	Consists of: -580 Right Single Pedestal Desk -589 Left Single Pedestal Return	72 48	36 24	30 30	287 190	59.3 27.8	\$ 2903.00 \$ 1742.00	
	Left							
	Right CPU Corner Unit 713_-76	72	84	30	444	86.6	\$ 4841.00	• Ventilated computer storage cabinet with 2 media drawers and power manager in return pedestal • Felt-lined box / box / file drawer in credenza pedestal
	Consists of: -389 Lt Sgl Computer Ped Return -517 Rt Sgl Ped Corner Credenza	48 72	24 36	30 30	176 268	27.3 59.3	\$ 1742.00 \$ 3099.00	
Right	Left CPU Corner Unit 713_-77	72	84	30	444	86.6	\$ 4841.00	
	Consists of: -379 Rt Sgl Computer Ped Return -518 Left Sgl Ped Corner Credenza	48 72	24 36	30 30	176 268	27.3 59.3	\$ 1742.00 \$ 3099.00	
	Left							
	Right Executive Corner U Desk 713_-78	72	110	30	620	123.1	\$ 6583.00	• Felt-lined box / box / file drawer per pedestal
	Consists of: -570 Left Single Pedestal Desk -517 Rt Sgl Ped Corner Credenza -69 Bridge	72 72 38	36 36 24	30 30 30	287 268 65	59.3 59.3 4.5	\$ 2903.00 \$ 3099.00 \$ 581.00	
Right	Left Executive Corner U Desk 713_-79	72	110	30	620	123.1	\$ 6583.00	
	Consists of: -580 Right Single Pedestal Desk -518 Left Sgl Ped Corner Credenza -69 Bridge	72 72 38	36 36 24	30 30 30	287 268 65	59.3 59.3 4.5	\$ 2903.00 \$ 3099.00 \$ 581.00	
	Left							
	Right Executive U with Corner Desk 713_-847	72	110	30	640	112.4	\$ 8250.00	• Felt-lined box / box / file drawer per pedestal
	Consists of: -770 Left Corner Single Ped Desk -571 Rt Single Pedestal Credenza -69 Bridge	72 72 38	48 24 24	30 30 30	300 275 65	70.8 37.1 4.5	\$ 4677.00 \$ 2992.00 \$ 581.00	
Right	Left Executive U with Corner Desk 713_-848	72	110	30	640	112.4	\$ 8250.00	
	Consists of: -780 Right Corner Single Ped Desk -581 Left Single Pedestal Credenza -69 Bridge	72 72 38	48 24 24	30 30 30	300 275 65	70.8 37.1 4.5	\$ 4677.00 \$ 2992.00 \$ 581.00	
	Left							





Belmont VENEER COLLECTION

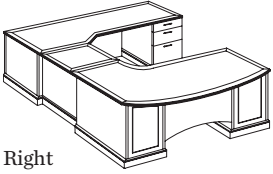
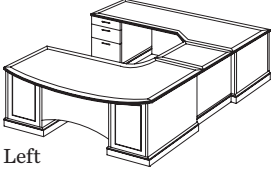
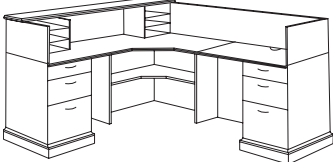
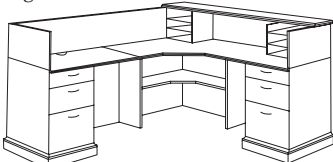
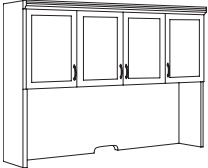

FLEXSTEEL®
CONTRACT

7130 Executive Cherry Finish / 7132 Brown Cherry Finish

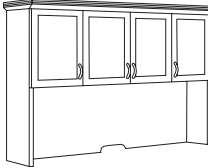

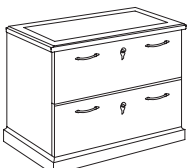



DMI COLLECTION

	Item Description	W"	D"	H"	Weight Lbs.	Cubic Ft.	List Price	Features
 Right	Right Executive Workstation U Desk 713_-845	72	120	30	618	135.3	\$ 8357.00	• Felt-lined box / box / file drawer per pedestal
	Consists of:							
	-770 Left Corner Single Ped Desk	72	48	30	300	70.8	\$ 4677.00	
	-517 Rt Sgl Ped Corner Credenza	72	36	30	268	59.3	\$ 3099.00	
	-69 Bridge	38	24	30	65	4.5	\$ 581.00	
 Left	Left Executive Workstation U Desk 713_-846	72	120	30	618	135.3	\$ 8357.00	
	Consists of:							
	-780 Right Corner Single Ped Desk	72	48	30	300	70.8	\$ 4677.00	
	-518 Left Sgl Ped Corner Credenza	72	36	30	268	59.3	\$ 3099.00	
	-69 Bridge	38	24	30	65	4.5	\$ 581.00	
 Right	Right Reception L Desk 713_-66	73.5	88.5	43	630	129.4	\$ 7461.00	• Box / box with dividers / file drawer per pedestal • Two letter organizers
	Consists of:							
	-680 Left Single Pedestal Desk	73.5	40.5	30	350	86.3	\$ 4424.00	
	-179 Right Single Pedestal Return	48	26.25	30	200	37.9	\$ 2062.00	
	-523 Risers		15	13	80	5.2	\$ 975.00	
 Left	Left Reception L Desk 713_-67	73.5	88.5	43	630	129.4	\$ 7461.00	
	Consists of:							
	-690 Right Single Pedestal Desk	73.5	40.5	30	350	86.3	\$ 4424.00	
	-189 Left Single Pedestal Return	48	26.25	30	200	37.9	\$ 2062.00	
	-524 Risers		15	13	80	5.2	\$ 975.00	
	Overhead Storage 713_-62	72	15	50	267	44.4	\$ 2517.00	• Three cabinets each with an adjustable shelf • 18" task light • 23.75" vertical clearance for monitor • For use with -21, -277
	Overhead Storage with Organizers 713_-625	72	15	50	340	51.8	\$ 3593.00	• Three cabinets each with an adjustable shelf • One organizer with two drawers and three letter trays; one organizer with seven letter trays • 18" task light • 23.75" vertical clearance for monitor • For use with -21, -277
	Consists of:							
	-62 Overhead Storage	72	15	50	267	44.4	\$ 2517.00	
	-621 Letter Tray/Drawer Organizer	16.75	11.75	23.75	39	3.7	\$ 538.00	
	-622 Letter Tray Organizer	16.75	11.75	23.75	34	3.7	\$ 538.00	
	Overhead Storage with Full Return Moulding 713_-63	74.5	15	50	250	44.4	\$ 2517.00	• Three cabinets each with an adjustable shelf • 18" task light • 23.75" vertical clearance for monitor • -63 for use with -21, -277
	713_-64	72	15	50	276	44.4	\$ 2517.00	• -64 for use with -23, -517, -518, -571, -581, -770, -780
	Overhead Storage with Full Return Moulding and Organizers 713_-635	74.5	15	50	323	51.8	\$ 3593.00	• Three cabinets each with an adjustable shelf • One organizer with two drawers and three letter trays; one organizer with seven letter trays • 18" task light • 23.75" vertical clearance for monitor • For use with -21, -277
	Consists of:							
	-63 Overhead Storage	74.5	15	50	250	44.4	\$ 2517.00	
	-621 Letter Tray/Drawer Organizer	16.75	11.75	23.75	39	3.7	\$ 538.00	
	-622 Letter Tray Organizer	16.75	11.75	23.75	34	3.7	\$ 538.00	
	Lateral File 713_-16	36	24	30	176	21.2	\$ 1549.00	• Two locking file drawers • Full return base mouldings • Anti-tip device

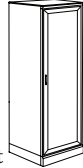
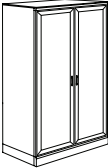

DMI COLLECTION

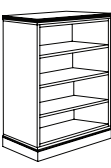

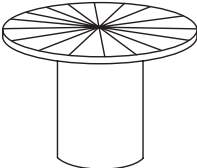



7130 Executive Cherry Finish / 7132 Brown Cherry Finish

Item Description		W"	D"	H"	Weight	Cubic	List	Features
Model Number					Lbs.	Ft.	Price	
 Right	Right Hand Facing Single Door Wardrobe 713_-05	18	24	78	200	25.3	\$ 2100.00	<ul style="list-style-type: none"> • Hanger rod • Five adjustable shelves • When creating a wall configuration with Belmont credenza and overhead, use the -63 or -635 overheads • -05 is hinged on right • -05LH is hinged on left
	Left Hand Facing Single Door Wardrobe 713_-05LH	18	24	78	200	25.3	\$ 2100.00	
	Double Door Wardrobe 713_-06	36	24	78	250	51.1	\$ 3892.00	<ul style="list-style-type: none"> • Hanger rod • Ten adjustable shelves • When creating a wall configuration with Belmont credenza and overhead, use the -63 or -635 overheads
	Lateral File Storage Unit 713_-07	36	24.5	80	332	54.1	\$ 3292.00	<ul style="list-style-type: none"> • Two lateral file drawers • Two-door cabinet with two adjustable shelves • When creating a wall configuration with Belmont credenza and overhead, use the -62 or -625 overheads
	Bookcase 713_-09	36	15	80	204	35.3	\$ 2063.00	<ul style="list-style-type: none"> • Two adjustable shelves • Two-door cabinet with an adjustable shelf • When creating a wall configuration with Belmont credenza and overhead, use the -62 or -625 overheads
	48" Bookcase 713_-048	36	15	48	100	19.7	\$ 1508.00	<ul style="list-style-type: none"> • Two adjustable shelves
	60" Bookcase 713_-060	36	15	60	150	24.4	\$ 1863.00	<ul style="list-style-type: none"> • Three adjustable shelves
	72" Bookcase 713_-072	36	15	72	175	28.3	\$ 2110.00	<ul style="list-style-type: none"> • Three adjustable shelves • One fixed shelf
	42" Round Conference Table 713_-89	42	42	30	125	12.6	\$ 1897.00	
	Consists of: -011 Top	42	42		40	4.4	\$ 1206.00	
	-005 Cylinder Base	20	20		85	8.2	\$ 691.00	
	48" Round Conference Table 713_-90	48	48	30	135	13.8	\$ 2415.00	
	Consists of: -016 Top	48	48		50	5.6	\$ 1724.00	
	-005 Cylinder Base	20	20		85	8.2	\$ 691.00	

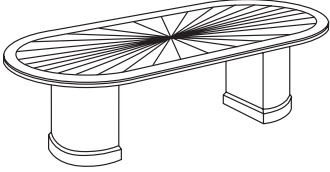
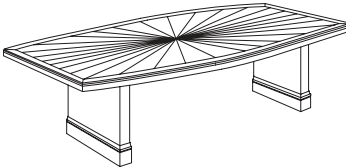
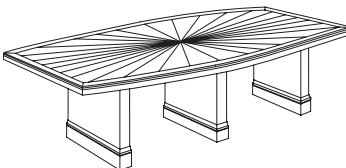
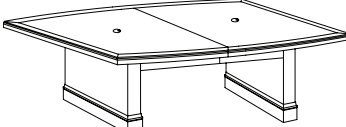

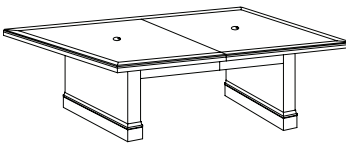
7130 Executive Cherry Finish / 7132 Brown Cherry Finish

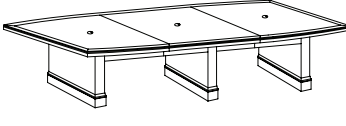
DMI COLLECTION

Item Description	W"	D"	H"	Weight Lbs.	Cubic Ft.	List Price	Features
 8' Race Track Conference Table 713_-96 Consists of: -961 Top -962 Bases (set)	96	48	30	276	26.3	\$ 4137.00	
	96	48		186	15.2	\$ 2758.00	
				90	11.1	\$ 1379.00	
 10' Boat Shaped Conference Table 713_-97 Consists of: -971 Top (2 piece) -972 Slab End Bases (set)	120	48	30	326	27.0	\$ 4307.00	• Table top comes in two pieces for ease in installation
	120	48		235	18.9	\$ 3101.00	
				91	8.1	\$ 1206.00	
 12' Boat Shaped Conference Table 7130-98 Consists of: -981 Top (2 piece) -982 Slab End Bases (3 piece set)	144	48	30	415	31.5	\$ 5242.00	• Available in 7130 Executive Cherry finish only • Table top comes in two pieces for ease in installation
	144	48		280	19.9	\$ 3448.00	
				135	11.6	\$ 1794.00	
 8' Boat Shaped Expandable Conference Table 713_-96EX Consists of: -9031 Left & Right Tops -9033 Bases (2 needed) -9034 Rail Set	96	48	30	300	25.4	\$ 3104.00	• Grommet in each top section • Optional storage base, -113, available • Grommets accommodate optional 0000-24, 0000-25 Mini Cove Power Center available
	48	48		150	11.4	\$ 1973.00	
	28	5.25	29	100	12.4	\$ 960.00	
	52			50	1.6	\$ 171.00	
 10' Boat Shaped Expandable Conference Table 713_-120EX Consists of: -9030 Left & Right Tops -9033 Bases (2 needed) -9038 Rail Set	120	48	30	330	31.9	\$ 3974.00	
	60	48		180	17.2	\$ 2820.00	
	28	5.25	29	100	12.4	\$ 960.00	
	76			50	2.3	\$ 194.00	
 8' Rectangular Expandable Conference Table 713_-96REX Consists of: -9028 Left & Right Tops -9033 Bases (2 needed) -9034 Rail Set	96	48	30	300	25.4	\$ 3014.00	• Grommet in each top section • Optional storage base, -113, available • Grommets accommodate optional 0000-24, 0000-25 Mini Cove Power Center available
	48	48		150	11.4	\$ 1883.00	
	28	5.25	29	100	12.4	\$ 960.00	
	52			50	1.6	\$ 171.00	
 10' Rectangular Expandable Conference Table 713_-120REX Consists of: -9029 Left & Right Tops -9033 Bases (2 needed) -9038 Rail Set	120	48	30	330	31.9	\$ 3760.00	
	60	48		180	17.2	\$ 2606.00	
	28	5.25	29	100	12.4	\$ 960.00	
	76			50	2.3	\$ 194.00	
 12' Boat Shaped Expandable Conference Table 713_-144EX Consists of: -9031 Left & Right Tops -9032 Center Top & Rails -9033 Bases (3 needed) -9035 Rail Set (2 needed)	144	48	30	475	41.6	\$ 4944.00	• Grommet in each top section • Optional storage base, -113, available • Grommets accommodate optional 0000-24, 0000-25 Mini Cove Power Center available
	48	48		150	11.4	\$ 1973.00	
	48	48		75	8.6	\$ 1217.00	
	28	5.25	29	150	18.6	\$ 1440.00	
	48			100	3.0	\$ 314.00	
 14' Boat Shaped Expandable Conference Table 713_-168EX Consists of: -9030 Left & Right Tops -9032 Center Top & Rails -9033 Bases (3 needed) -9037 Rail Set (2 needed)	168	48	30	505	48.2	\$ 5815.00	
	60	48		180	17.2	\$ 2820.00	
	48	48		75	8.6	\$ 1217.00	
	28	5.25	29	150	18.6	\$ 1440.00	
	60.5			100	3.8	\$ 338.00	



Item Description	W"	D"	H"	Weight Lbs.	Cubic Ft.	List Price	Features
12' Rectangular Expandable Conference Table 713_-144REX	144	48	30	475	41.6	\$ 4854.00	<ul style="list-style-type: none"> • Grommet in each top section • Optional storage base, -113, available • Grommets accommodate optional 0000-24, 0000-25 Mini Cove Power Center available
Consists of:							
-9028 Left & Right Tops	48	48		150	11.4	\$ 1883.00	
-9032 Center Top & Rails	48	48		75	8.6	\$ 1217.00	
-9033 Bases (3 needed)	28	5.25	29	150	18.6	\$ 1440.00	
-9035 Rail Set (2 needed)	48			100	3.0	\$ 314.00	
14' Rectangular Expandable Conference Table 713_-168REX	168	48	30	505	48.2	\$ 5601.00	
Consists of:							
-9029 Left & Right Tops	60	48		180	17.2	\$ 2606.00	
-9032 Center Top & Rails	48	48		75	8.6	\$ 1217.00	
-9033 Bases (3 needed)	28	5.25	29	150	18.6	\$ 1440.00	
-9037 Rail Set (2 needed)	60.5			100	3.8	\$ 338.00	
16' Boat Shaped Expandable Conference Table 713_-192EX	192	48	30	600	56.4	\$ 6641.00	<ul style="list-style-type: none"> • Grommet in each top section • Optional storage base, -113, available • Grommets accommodate optional 0000-24, 0000-25 Mini Cove Power Center available
Consists of:							
-9031 Left & Right Tops	48	48		150	11.4	\$ 1973.00	
-9032 Center Top & Rails (2 needed)	48	48		150	17.2	\$ 2434.00	
-9033 Bases (4 needed)	28	5.25	29	200	24.8	\$ 1920.00	
-9035 Rail Set (2 needed)	48			100	3.0	\$ 314.00	
18' Boat Shaped Expandable Conference Table 713_-216EX	216	48	30	630	63.0	\$ 7512.00	
Consists of:							
-9030 Left & Right Tops	60	48		180	17.2	\$ 2820.00	
-9032 Center Top & Rails (2 needed)	48	48		150	17.2	\$ 2434.00	
-9033 Bases (4 needed)	28	5.25	29	200	24.8	\$ 1920.00	
-9037 Rail Set (2 needed)	60.5			100	3.8	\$ 338.00	
16' Rectangular Expandable Conference Table 713_-192REX	192	48	30	600	56.4	\$ 6551.00	<ul style="list-style-type: none"> • Grommet in each top section • Optional storage base, -113, available • Grommets accommodate optional 0000-24, 0000-25 Mini Cove Power Center available
Consists of:							
-9028 Left & Right Tops	48	48		150	11.4	\$ 1883.00	
-9032 Center Top & Rails (2 needed)	48	48		150	17.2	\$ 2434.00	
-9033 Bases (4 needed)	28	5.25	29	200	24.8	\$ 1920.00	
-9035 Rail Set (2 needed)	48			100	3.0	\$ 314.00	
18' Rectangular Expandable Conference Table 713_-216REX	216	48	30	630	63.0	\$ 7298.00	
Consists of:							
-9029 Left & Right Tops	60	48		180	17.2	\$ 2606.00	
-9032 Center Top & Rails (2 needed)	48	48		150	17.2	\$ 2434.00	
-9033 Bases (4 needed)	28	5.25	29	200	24.8	\$ 1920.00	
-9037 Rail Set (2 needed)	60.5			100	3.8	\$ 338.00	
20' Boat Shaped Expandable Conference Table 713_-240EX	240	48	30	725	71.2	\$ 8338.00	<ul style="list-style-type: none"> • Grommet in each top section • Optional storage base, -113, available • Grommets accommodate optional 0000-24, 0000-25 Mini Cove Power Center available
Consists of:							
-9031 Left & Right Tops	48	48		150	11.4	\$ 1973.00	
-9032 Center Top & Rails (3 needed)	48	48		225	25.8	\$ 3651.00	
-9033 Bases (5 needed)	28	5.25	29	250	31.0	\$ 2400.00	
-9035 Rail Set (2 needed)	48			100	3.0	\$ 314.00	
22' Boat Shaped Expandable Conference Table 713_-264EX	264	48	30	755	77.8	\$ 9209.00	
Consists of:							
-9030 Left & Right Tops	60	48		180	17.2	\$ 2820.00	
-9032 Center Top & Rails (3 needed)	48	48		225	25.8	\$ 3651.00	
-9033 Bases (5 needed)	28	5.25	29	250	31.0	\$ 2400.00	
-9037 Rail Set (2 needed)	60.5			100	3.8	\$ 338.00	



7130 Executive Cherry Finish / 7132 Brown Cherry Finish



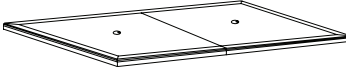



DMI COLLECTION

Item Description	W"	D"	H"	Weight Lbs.	Cubic Ft.	List Price	Features
20' Rectangular Expandable Conference Table 713_-240REX Consists of: -9028 Left & Right Tops -9032 Center Top & Rails (3 needed) -9033 Bases (5 needed) -9035 Rail Set (2 needed)	240	48	30	725	71.2	\$ 8248.00	<ul style="list-style-type: none"> Grommet in each top section Optional storage base, -113, available Grommets accommodate optional 0000-24, 0000-25 Mini Cove Power Center available
							
22' Rectangular Expandable Conference Table 713_-264REX Consists of: -9029 Left & Right Tops -9032 Center Top & Rails (3 needed) -9033 Bases (5 needed) -9037 Rail Set (2 needed)	264	48	30	755	77.8	\$ 8995.00	
							
48" Left & Right Section Rectangular Expandable Conference Table Top 713_-9028	96	48		150	11.4	\$ 1883.00	<ul style="list-style-type: none"> Two piece tops Grommet in each top section Grommets accommodate optional 0000-24, 0000-25 Mini Cove Power Center available
60" Left & Right Section Rectangular Expandable Conference Table Top 713_-9029	120	48		180	17.2	\$ 2606.00	
48" Left & Right Section Boat Shaped Expandable Conference Table Top 713_-9031	96	48		150	11.4	\$ 1973.00	<ul style="list-style-type: none"> Two piece tops Grommet in each top section Grommets accommodate optional 0000-24, 0000-25 Mini Cove Power Center available
60" Left & Right Section Boat Shaped Expandable Conference Table Top 713_-9030	120	48		180	17.2	\$ 2820.00	
48" Center Section Expandable Conference Table Top with 44" Rails 713_-9032	48	48		75	8.6	\$ 1217.00	<ul style="list-style-type: none"> Rails include wire management tray for top Grommet in top Grommet accommodates optional 0000-24, 0000-25 Mini Cove Power Center available
Expandable Conference Table Base 713_-9033	29.5	5.5	29	50	6.2	\$ 480.00	<ul style="list-style-type: none"> -113 must be placed at the end of the table
Expandable Conference Table Storage Base 713_-113	29.5	5.5	29	48	6.3	\$ 529.00	
48" Center Section Top and Base 713_-903233 Consists of: -9032 Center Top & Rails -9033 Base	48	48	30	125	14.8	\$ 1697.00	<ul style="list-style-type: none"> Grommet in top Grommet accommodates optional 0000-24, 0000-25 Mini Cove Power Center available
Expandable Conference Table Rail Sets 713_-9034 713_-9035 713_-9037 713_-9038	52 48 60.5 76	.75 .75 .75 .75	4 4 4 4	50 50 50 50	1.6 1.5 1.9 2.3	\$ 171.00 \$ 157.00 \$ 169.00 \$ 194.00	<ul style="list-style-type: none"> Includes wire management tray for top -9034 rail set for -96EX, -96REX -9035 rail set for -9028, -9031 -9037 rail set for -9029, -9030 -9038 rail set for -120EX, -120REX
Buffet 713_-25B	66	24	36	200	41.0	\$ 3362.00	<ul style="list-style-type: none"> Two felt-lined, fully extending drawers with one drawer having a silverware holder Two cabinets each with an adjustable shelf Four, heavy duty casters Optional 0000-40 Power Center (see Accessories section) is ideal when using a TV or other electronics with the buffet

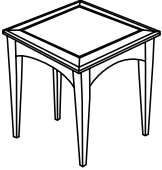
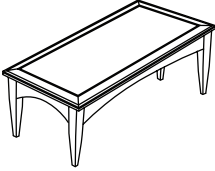

DMI COLLECTION

7130 Executive Cherry Finish / 7132 Brown Cherry Finish

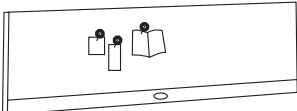
	Item Description Model Number	W"	D"	H"	Weight Lbs.	Cubic Ft.	List Price	Features
	Two Door Buffet 713_-26B	38	24	36	175	27.0	\$ 2790.00	<ul style="list-style-type: none"> Felt-lined, fully extending drawer One cabinet with an adjustable shelf Four, heavy duty casters Optional 0000-40 Power Center (see Accessories section) is ideal when using a TV or other electronics with the buffet
	Presentation Board 713_-650	48	3.75	49	106	9.4	\$ 1629.00	<ul style="list-style-type: none"> Open: 96" x 3.75" x 49" Features marker board and tack boards on the interior of each door
	End Table 713_-10	24	24	24	30	4.9	\$ 707.00	<ul style="list-style-type: none"> Construction of veneer on MDF with wood legs
	Coffee Table 713_-40	48	24	18	40	6.4	\$ 920.00	<ul style="list-style-type: none"> Construction of veneer on MDF with wood legs
	Sofa/Console Table 713_-84	48	16	28	53	5.0	\$ 886.00	<ul style="list-style-type: none"> Construction of veneer on MDF with wood legs
	Executive Leather High Back Chair 713_-80	26.5	28.5	45-48	71	17.4	\$ 1285.00	<ul style="list-style-type: none"> Upholstered in black leather Five star base Knee tilt mechanism 18" seat depth Seat height adjusts from 20"-23"
	Executive Leather Med Back Chair 713_-81	26.5	28.5	38.5-42.5	63	12.5	\$ 1168.00	<ul style="list-style-type: none"> Upholstered in black leather Five star base Knee tilt mechanism 18" seat depth Seat height adjusts from 20"-23"
	Black Cloth Tack Board 0000-341	69.75	23.5		12	2.0	\$ 344.00	<ul style="list-style-type: none"> For use on -62, -63 & -64



Del Mar

VENEER COLLECTION

7302 Sedona Cherry Finish

Clean lines embellished by rich wood grain.

The true beauty of the Del Mar Collection lies in simple forms and fine details that feel at home in any professional environment. With subtle Shaker influences, this minimal design creates a canvas for striking Sapele Pommele veneers in a Sedona Cherry finish.

Details:

- Construction consists of wood, wood veneers and wood product
- Durable mortise and tenon construction with wood cleats, glue, screws and staples, threaded inserts and bolts
- All top surfaces have a protective UV finish resistant to stains, mars and scratches
- The desk top features Sapele Pommele veneer panels offset with ebony borders and cherry veneers
- All drawers feature dovetail construction and are suspended on fully extending, metal, ball-bearing slides
- Locking pedestals via knee space located locks
- Box drawers rated for 75 lbs
- File drawers rated for 150 lbs
- File drawers equipped with metal rods for letter or legal sized hanging files
- Adjustable floor levelers



FLEXSTEEL®
CONTRACT

DMI COLLECTION



Del Mar VENEER COLLECTION



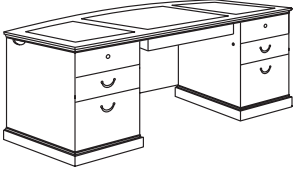
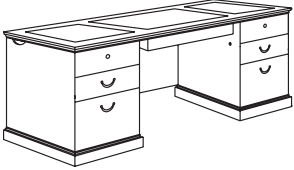
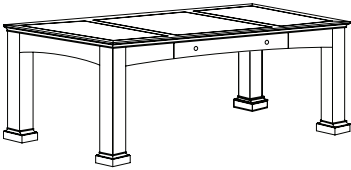
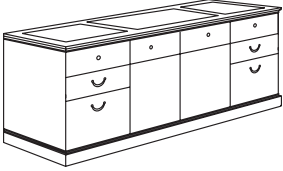
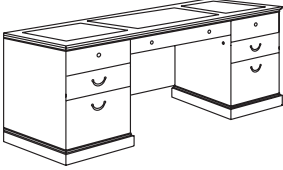
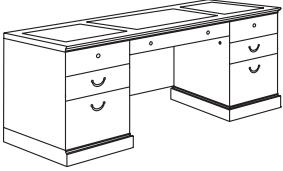
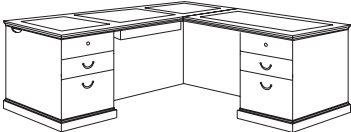

FLEXSTEEL®
CONTRACT

7302 Sedona Cherry Finish

DMI COLLECTION

Item Description		W"	D"	H"	Weight Lbs.	Cubic Ft.	List Price	Features
Model Number								
	Executive Bow Front Desk 7302-37	72	42	30	450	60.0	\$ 3750.00	<ul style="list-style-type: none"> • Keyboard drawer with keyboard tray • Box with pencil tray / box / file drawer • Grommet in each end panel
	Executive Desk 7302-36	72	36	30	370	57.4	\$ 3311.00	<ul style="list-style-type: none"> • Keyboard drawer with keyboard tray • Box with pencil tray / box / file drawer • Grommet in each end panel
	Table Desk 7302-88 Consists of: -082 Top -081 Four Leg Base	72	36	30	196	20.9	\$ 2058.00	<ul style="list-style-type: none"> • Utility drawer with a pencil tray
	Executive Storage Credenza 7302-20	72	24	30	325	39.8	\$ 3113.00	<ul style="list-style-type: none"> • Box / box / file drawer per pedestal • Two-door cabinet with an adjustable shelf
	Kneehole Credenza 7302-21	72	24	30	280	39.8	\$ 2750.00	<ul style="list-style-type: none"> • Center drawer has a hinged drop-front for use as a utility or keyboard drawer, includes a pencil tray • Box with a pencil tray / box / file drawer per pedestal
	Kneehole Credenza without Return Moulding 7302-215	69.5	24	30	280	38.4	\$ 2750.00	<ul style="list-style-type: none"> • Center drawer has a hinged drop-front for use as a utility or keyboard drawer, includes a pencil tray • Box with a pencil tray / box / file drawer per pedestal • For use in wall configurations
	Right Executive L Desk 7302-47 Consists of: -570 Left Single Pedestal Desk -579 Right Single Pedestal Return	72	84	30	454	82.5	\$ 4778.00	<ul style="list-style-type: none"> • Keyboard drawer with a keyboard tray on single pedestal desk • Box / box / file drawer per pedestal • Grommet in each desk end panel and on return top
	Left Executive L Desk 7302-48 Consists of: -580 Right Single Pedestal Desk -589 Left Single Pedestal Return	72	84	30	454	82.5	\$ 4778.00	

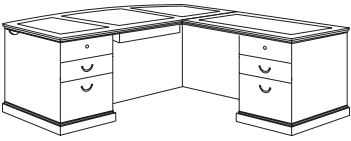
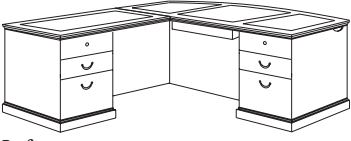
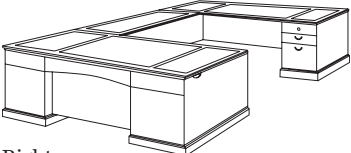
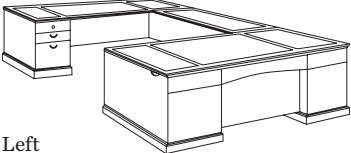
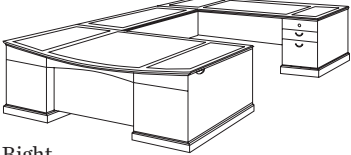

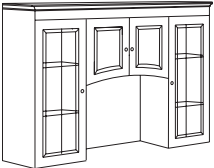
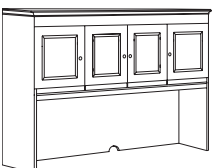
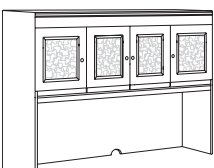
	Item Description	W"	D"	H"	Weight Lbs.	Cubic Ft.	List Price	Features
	Right Executive Bow Front L Desk 7302-67	72	90	30	464	91.0	\$ 5257.00	<ul style="list-style-type: none"> • Keyboard drawer with a keyboard tray on single pedestal desk • Box / box / file drawer per pedestal • Grommet in each desk end panel and on return top
	Consists of: -670 Left Bow Single Ped Desk 72 42 30 300 65.9 \$ 3192.00 -579 Right Single Pedestal Return 48 22 30 164 25.1 \$ 2065.00							
	Left Executive Bow Front L Desk 7302-68	72	90	30	464	91.0	\$ 5257.00	
	Consists of: -680 Right Bow Single Ped Desk 72 42 30 300 65.9 \$ 3192.00 -589 Left Single Pedestal Return 48 22 30 164 25.1 \$ 2065.00							
	Right Executive U Desk 7302-57	72	108	30	601	104.0	\$ 6143.00	<ul style="list-style-type: none"> • Keyboard drawer with a keyboard tray on single ped desk • Box / box / file drawer per pedestal
	Consists of: -570 Left Single Pedestal Desk 72 36 30 290 57.4 \$ 2713.00 -571 Right Single Ped Credenza 72 24 30 233 39.8 \$ 2393.00 -59 U Bridge 48 24 30 88 6.8 \$ 1037.00							
	Left Executive U Desk 7302-58	72	108	30	601	104.0	\$ 6143.00	
	Consists of: -580 Right Single Pedestal Desk 72 36 20 290 57.4 \$ 2713.00 -581 Left Single Pedestal Credenza 72 24 30 233 39.8 \$ 2393.00 -59 U Bridge 48 24 30 88 6.8 \$ 1037.00							
	Right Executive Bow Front U Desk 7302-77	72	114	30	611	112.5	\$ 6622.00	<ul style="list-style-type: none"> • Keyboard drawer with a keyboard tray on single ped desk • Box / box / file drawer per pedestal
	Consists of: -670 Left Bow Single Ped Desk 72 42 30 300 65.9 \$ 3192.00 -571 Right Single Ped Credenza 72 24 30 233 39.8 \$ 2393.00 -59 U Bridge 48 24 30 88 6.8 \$ 1037.00							
	Left Executive Bow Front U Desk 7302-78	72	114	30	611	112.5	\$ 6622.00	
	Consists of: -680 Right Bow Single Ped Desk 72 42 30 300 65.9 \$ 3192.00 -581 Left Single Pedestal Credenza 72 24 30 233 39.8 \$ 2393.00 -59 U Bridge 48 24 30 88 6.8 \$ 1037.00							
	Overhead Storage 7302-62	72	16	48	247	42.9	\$ 2314.00	<ul style="list-style-type: none"> • Three cabinets with glass paneled doors • Each cabinet has a canister light • Tower cabinets have two adjustable glass shelves • Euro-style door hinges • 25" center vertical clearance for monitor • Task light • For use with -20, -21, -571, -581
	Overhead Storage with Beveled Glass 7302-6251	72	16	48	265	43.0	\$ 2314.00	<ul style="list-style-type: none"> • Three cabinets, each with a canister light • Letter organizers • Euro-style door hinges • Removable side moldings • 23" vertical clearance for monitor • Task light • For use with -20, -21, -571, -581
	Overhead Storage with Crackle Glass 7302-404	69.5	16	48	250	43.3	\$ 2314.00	<ul style="list-style-type: none"> • Three cabinets, each with a canister light • Letter organizers • Concealed Euro style hinges • 23" vertical clearance for monitor • Can be used in wall applications utilizing -04, -05, -06, -07









Del Mar VENEER COLLECTION

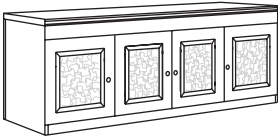

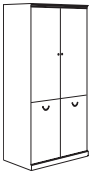
FLEXSTEEL®
CONTRACT

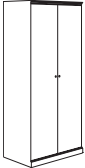
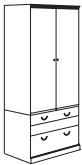
7302 Sedona Cherry Finish

DMI COLLECTION

Item Description		W"	D"	H"	Weight Lbs.	Cubic Ft.	List Price	Features
Model Number								
	Wall Mountable Overhead Storage with Crackle Glass 7302-403	69.5	16	25	148	22.6	\$ 1795.00	<ul style="list-style-type: none"> • Three cabinets, each with a canister light • Concealed Euro style door hinges • Mounts to wall with screws and 2" metal rail • For use above -215 and can be attached to -04 media cabinet, -05 single door wardrobe / cabinet, -06 double door wardrobe / cabinet, -07 lateral file cabinet
	Lateral File 7302-16	36	24	30	150	20.7	\$ 1523.00	<ul style="list-style-type: none"> • Two fully extending, 18" deep lateral file drawers • Central locking • Equipped with an anti-tip device
	Media Cabinet 7302-04	42	24	78	158	59.2	\$ 2954.00	<ul style="list-style-type: none"> • Top cabinet features two pocket doors, media shelf and a removable pegboard back panel • Bottom cabinet has an adjustable shelf and 3" cable grommet
 	Left Hand Facing Single Door Storage Wardrobe/Cabinet 7302-05	18	24	78	89	28.1	\$ 1835.00	<ul style="list-style-type: none"> • 4 adjustable/removable shelves • Euro style door hinges • Hanger rod • -05 is hinged on left • -05RH is hinged on right
Left	Right Hand Facing Single Door Storage Wardrobe/Cabinet 7302-05RH	18	24	78	89	28.1	\$ 1835.00	
	Double Door Storage Wardrobe/Cabinet 7302-06	33.75	24	78	145	48.8	\$ 2474.00	<ul style="list-style-type: none"> • 8 adjustable/removable shelves • Euro style door hinges • Hanger rod • 3" grommet in back panel
	Lateral File Storage Cabinet 7302-07	36	24	78	303	50.1	\$ 2954.00	<ul style="list-style-type: none"> • Two lateral file drawers with central locking • Drawers accommodate letter and/or legal hanging files • Cabinet with Euro style door hinges and two adjustable/removable shelves • 3" grommet in cabinet back panel • Anti-tip mechanism
	Center Bookcase 7302-108	33.5	16	78	148	33.1	\$ 1635.00	<ul style="list-style-type: none"> • Four adjustable shelves • Fixed base shelf
 	Left Hand Facing Bookcase 7302-118	34.75	16	78	150	34.2	\$ 1635.00	<ul style="list-style-type: none"> • Four adjustable shelves • Fixed base shelf
Left	Right Hand Facing Bookcase 7302-128	34.75	16	78	150	34.2	\$ 1635.00	
	Open Bookcase 7302-148	36	16	45	102	22.4	\$ 1199.00	<ul style="list-style-type: none"> • Two adjustable shelves • For use with -16 • Includes felt-pads



DMI COLLECTION

7302 Sedona Cherry Finish

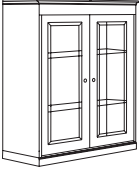
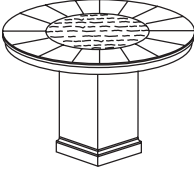
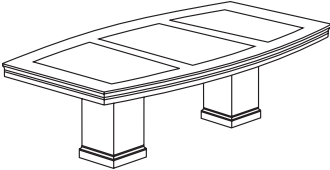
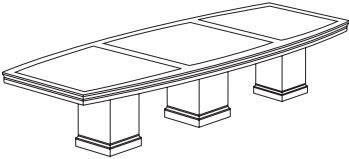
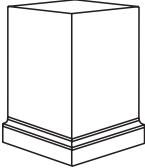
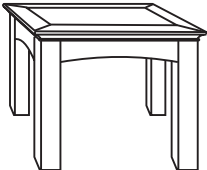
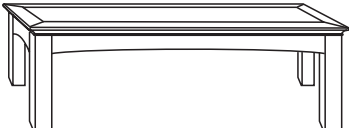
	Item Description	W"	D"	H"	Weight	Cubic	List	Features
	Model Number				Lbs.	Ft.	Price	
	Closed Bookcase 7302-248	36	16	48.25	152	22.4	\$ 1675.00	<ul style="list-style-type: none"> • Glass front doors • Canister light • Concealed Euro style hinges • Two adjustable glass shelves • For use with -16 • Includes adjustable glides and felt-pads
	42" Round Conference Table 7302-89	42	42	30	150	15.8	\$ 1997.00	<ul style="list-style-type: none"> • Optional storage base available
	Consists of:							
	-011 Top	42	42		88	6.5	\$ 1358.00	
	-003 Square Ped Base	18	18		62	9.3	\$ 639.00	
	48" Round Conference Table 7302-90	48	48	30	166	18.1	\$ 2553.00	
	Consists of:							
	-016 Top	48	48		104	8.8	\$ 1914.00	
	-003 Square Ped Base	18	18		62	9.3	\$ 639.00	
	8' Boat Shaped Conference Table 7302-96	96	42	30	331	38.9	\$ 3231.00	<ul style="list-style-type: none"> • Optional storage base available
	Consists of:							
	-004 Top	96	42		207	20.3	\$ 1953.00	
	-003 Square Ped Base (2 needed)	18	18		124	18.6	\$ 1278.00	
	10' Boat Shaped Conference Table 7302-120	120	48	30	384	40.2	\$ 3711.00	
	Consists of:							
	-005 Top (2 piece)	120	48		260	21.6	\$ 2433.00	
	-003 Square Ped Base (2 needed)	18	18		124	18.6	\$ 1278.00	
	12' Boat Shaped Conference Table 7302-144	144	48	30	492	53.2	\$ 5146.00	<ul style="list-style-type: none"> • Optional storage base available
	Consists of:							
	-006 Top (2 piece)	144	48		306	25.3	\$ 3229.00	
	-003 Square Ped Base (3 needed)	18	18		186	27.9	\$ 1917.00	
	Optional Storage Base 7302-013	18.5	18.5	29.25	62	8.1	\$ 695.00	<ul style="list-style-type: none"> • Optional base for use on conference tables • Hidden storage cabinet measures 13.25 x 13.25 x 22.5 • Removable shelf
	End Table 7302-10	24	24	20	49	3.2	\$ 652.00	<ul style="list-style-type: none"> • Construction of veneer on MDF with wood legs
	Coffee Table 7302-40	50	24	16	75	3.6	\$ 905.00	<ul style="list-style-type: none"> • Construction of veneer on MDF with wood legs





Del Mar VENEER COLLECTION



FLEXSTEEL®
CONTRACT

7302 Sedona Cherry Finish

DMI COLLECTION

Item Description Model Number	W"	D"	H"	Weight Lbs.	Cubic Ft.	List Price	Features
 Sofa/Console Table 7302-82	60	16	30	78	5.7	\$ 882.00	<ul style="list-style-type: none"> • Construction of veneer on MDF with wood legs
 Swan Executive High Back Chair with Upholstered Arms 7302-835	28.75	29.75	41.5-44.5	74	17.4	\$ 1089.00	<ul style="list-style-type: none"> • Black leather upholstery • Gas lift • Swivel tilt mechanism • Five star hooded caster base • Seat width: 20.5" • Seat depth: 19.5" • Seat height: 20.5-23.5"
 Swan Executive High Back Chair with Wood/Upholstered Arms 7302-836	28.75	29.75	40.5-43.75	74	17.4	\$ 1089.00	<ul style="list-style-type: none"> • Black leather upholstery • Gas lift • Swivel tilt mechanism • Five star hooded caster base • Seat width: 19.25" • Seat depth: 20" • Seat height: 20-24"
 Swan High Back Guest Chair 7302-821	27.5	28	41	55	21.6	\$ 1015.00	<ul style="list-style-type: none"> • Black leather upholstery • Seat width: 17-19.5" • Seat depth: 18" • Seat height: 19"



Causeway

LAMINATE COLLECTION

7040 Mocha / 7041 Honey Maple / 7042 Mahogany / 7043 White* / 7047 Walnut Finishes

Modular designs for efficient office spaces.

With multiple colors, and endless combinations, this easy to configure group can grow with you and your team. Causeways modular nature allows you to design and adjust as your workload, team and environment demand.

Details:

- Construction consists of mortise and tenon construction with wood cleats, glue, screws, staples, and threaded inserts with bolts
- Tops feature a slight 1/8" radius top edge and a construction of 1-1/8" thermally fused laminate on wood product with 3mm PVC edge bands
- All drawers feature a 5-sided construction with black vinyl interiors and full extension, metal ball bearing slides
- Locking drawers are all keyed the same. If you need specific items keyed differently, please contact your customer service representative.
- Box drawers rated for 75 lbs
- File drawers rated for 150 lbs
- File drawers equipped with metal rods for letter or legal sized hanging files
- Adjustable floor levelers
- Requires assembly

***White Laminate Finish available on select pieces**



FLEXSTEEL®
CONTRACT

DMI COLLECTION



For typical layouts and more information, please see our Causeway Playbook Typical Reference Guide

A "crossover" product, serving as a bridge between standard commercial office and home office applications into benching and desking applications. Causeway includes modular components featuring a laminate construction on wood product with PVC edges.

Pedestals, cabinets, including overheads, and other chasis components are available in three, wood grained laminate finishes: mocha, honey maple and mahogany.

Overhead doors are available in the three wood grained laminate finishes and in aluminum framed white glass.

Tops/writing surfaces are available in the three wood grained laminate finishes and in white laminate.

Modesty panels are available in the three wood grained laminate finishes with some also available in aluminum framed white glass.

All items, with the exceptions of pedestals and benches, ship Flat Packed and require assembly

7040: mocha finish

7041: honey maple finish

7042: mahogany finish

7043: white laminate finish

7047: walnut finish

7049: white glass only or generic items

Kit = End Item (order by)

Typical = components or kits grouped together (cannot order by)

How to Order:

- Determine configuration required (L, U, Peninsula, Standard Office, etc.)
- Determine size required
- Select color(s)
- Select top size and color
- Select pedestals or support frames
- Select top support rail if span between supports is longer than 44" (not required but will keep top from sagging overlong term)
- Select modesty panel option
- Select overhead and storage units
- Select door option for storage unit (if applicable)
- Select divider style (size)
 - Select standard white acrylic, custom acrylic, or tackboard and advise layout

Benching:

- Pick benching style
- Pick benching top option (fabric, laminate, or none)

- If there is a need for power and data support pick data port option(s)



DMI COLLECTION

7040 Mocha / 7041 Honey Maple / 7042 Mahogany / 7043 White* / 7047 Walnut Finishes

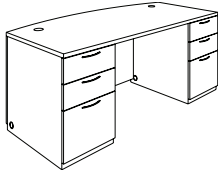

72" Executive Bow Front Desk

72W X 36D X 30H
704_-7236BXDXD \$ 1844.00
One color with laminate modesty
704_-8221 top
704_-8222 modesty
704_-831 b/b/f peds (2)

704_-7236BWDXD \$ 1844.00
One color chassis with white top
7043-8221 top
704_-8222 modesty
704_-831 b/b/f peds (2)

704_-7236BXDWD \$ 2058.00
One color with white glass modesty
704_-8221 top
7049-8223WG glass modesty
704_-831 b/b/f peds (2)

704_-7236BWDWD \$ 2058.00
White top and glass modesty panel
7043-8221 top
7049-8223WG glass modesty
704_-831 b/b/f peds (2)

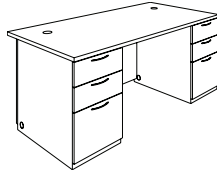

72" Executive Desk

72W X 36D X 30H
704_-7236XXDXD \$ 1844.00
One color with laminate modesty
704_-8211 top
704_-8222 modesty
704_-831 b/b/f peds (2)

704_-7236XWDXD \$ 1844.00
One color chassis with white top
7043-8211 top
704_-8222 modesty
704_-831 b/b/f peds (2)

704_-7236XXDWD \$ 2058.00
One color with white glass modesty
704_-8211 top
7049-8223WG glass modesty
704_-831 b/b/f peds (2)

704_-7236XWDWD \$ 2058.00
White top and glass modesty panel
7043-8211 top
7049-8223WG glass modesty
704_-831 b/b/f peds (2)

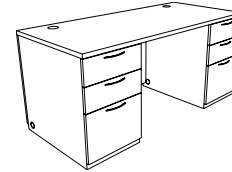

66" Junior Executive Desk

66W X 30D X 30H
704_-6630XXDXD \$ 1718.00
One color with laminate modesty
704_-9211 top
704_-9222 modesty
704_-831 b/b/f peds (2)

704_-6630XWDXD \$ 1718.00
One color chassis with white top
7043-9211 top
704_-9222 modesty
704_-831 b/b/f peds (2)

704_-6630XXDWD \$ 1926.00
One color with white glass modesty
704_-9211 top
7049-9223WG glass modesty
704_-831 b/b/f peds (2)

704_-6630XWDWD \$ 1926.00
White top and glass modesty panel
7043-9211 top
7049-9223WG glass modesty
704_-831 b/b/f peds (2)

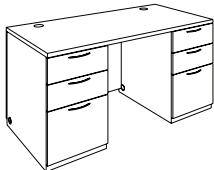

60" Junior Executive Desk

60W X 30D X 30H
704_-6030XXDXD \$ 1691.00
One color with laminate modesty
704_-6211 top
704_-6223 modesty
704_-831 b/b/f peds (2)

704_-6030XWDXD \$ 1691.00
One color chassis with white top
7043-6211 top
704_-6223 modesty
704_-831 b/b/f peds (2)

704_-6030XXDWD \$ 1849.00
One color with white glass modesty
704_-6211 top
7049-6223WG glass modesty
704_-831 b/b/f peds (2)

704_-6030XWDWD \$ 1849.00
White top and glass modesty panel
7043-6211 top
7049-6223WG glass modesty
704_-831 b/b/f peds (2)

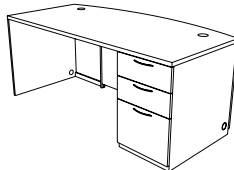

72" Executive Right Sgl Ped Bow Front Desk

72W X 36D X 30H
704_-7236BXAXR \$ 1412.00
One color with laminate modesty
704_-8221 top
7049-1192 support rail
704_-8222 modesty
704_-831 b/b/f ped
704_-1182L wing end assembly

704_-7236BWAXR \$ 1412.00
One color with laminate modesty
7043-8221 top
7049-1192 support rail
704_-8222 modesty
704_-831 b/b/f ped
704_-1182L wing end assembly

704_-7236BXAWR \$ 1626.00
One color chassis with white glass modesty
704_-8221 top
7049-1192 support rail
7049-8223WG glass modesty
704_-831 b/b/f ped
704_-1182L wing end assembly

704_-7236BWAWR \$ 1626.00
White top and glass modesty panel
7043-8221 top
7049-1192 support rail
7049-8223WG glass modesty
704_-831 b/b/f ped
704_-1182L wing end assembly

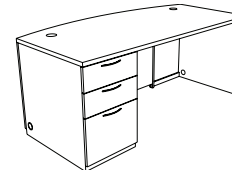

72" Executive Left Sgl Ped Bow Front Desk

72W X 36D X 30H
704_-7236BXAXL \$ 1412.00
One color with laminate modesty
704_-8221 top
7049-1192 support rail
704_-8222 modesty
704_-831 b/b/f ped
704_-1182R wing end assembly

704_-7236BWAXL \$ 1412.00
One color with laminate modesty
7043-8221 top
7049-1192 support rail
704_-8222 modesty
704_-831 b/b/f ped
704_-1182R wing end assembly

704_-7236BXAWL \$ 1626.00
One color chassis with white glass modesty
704_-8221 top
7049-1192 support rail
7049-8223WG glass modesty
704_-831 b/b/f ped
704_-1182R wing end assembly

704_-7236BWAWL \$ 1626.00
White top and glass modesty panel
7043-8221 top
7049-1192 support rail
7049-8223WG glass modesty
704_-831 b/b/f ped
704_-1182R wing end assembly

*White Laminate Finish available on select pieces

Causeway LAMINATE COLLECTION



FLEXSTEEL®
CONTRACT

7040 Mocha / 7041 Honey Maple / 7042 Mahogany / 7043 White* / 7047 Walnut Finishes

DMI COLLECTION

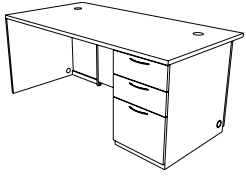

72" Executive Right Single Pedestal Desk

72W X 36D X 30H
704_-7236XXAXR \$ 1412.00
One color with laminate modesty
704_-8211 top
7049-1192 support rail
704_-8222 modesty
704_-831 b/b/f ped
704_-1182L wing end assembly

704_-7236XWAXR \$ 1412.00
One color chassis with white top
7043-8211 top
7049-1192 support rail
704_-8222 modesty
704_-831 b/b/f ped
704_-1182L wing end assembly

704_-7236XXAWR \$ 1626.00
One color chassis with white glass modesty
704_-8211 top
7049-1192 support rail
7049-8223WG glass modesty
704_-831 b/b/f ped
704_-1182L wing end assembly

704_-7236XWAWR \$ 1626.00
White top and glass modesty panel
7043-8211 top
7049-1192 support rail
7049-8223WG glass modesty
704_-831 b/b/f ped
704_-1182L wing end assembly

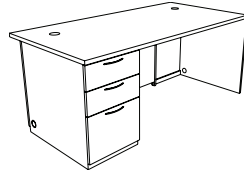

72" Executive Left Single Pedestal Desk

72W X 36D X 30H
704_-7236XXAXL \$ 1412.00
One color with laminate modesty
704_-8211 top
7049-1192 support rail
704_-8222 modesty
704_-831 b/b/f ped
704_-1182R wing end assembly

704_-7236XWAXL \$ 1412.00
One color chassis with white top
7043-8211 top
7049-1192 support rail
704_-8222 modesty
704_-831 b/b/f ped
704_-1182R wing end assembly

704_-7236XXAWL \$ 1626.00
One color chassis with white glass modesty
704_-8211 top
7049-1192 support rail
7049-8223WG glass modesty
704_-831 b/b/f ped
704_-1182R wing end assembly

704_-7236XWAWL \$ 1626.00
White top and glass modesty panel
7043-8211 top
7049-1192 support rail
7049-8223WG glass modesty
704_-831 b/b/f ped
704_-1182R wing end assembly

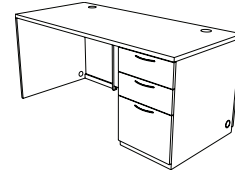

66" Right Single Pedestal Desk

66W X 30D X 30H
704_-6630XXAXR \$ 1275.00
One color with laminate modesty
704_-9211 top
7049-1193 support rail
704_-9222 modesty
704_-831 b/b/f ped
704_-1182L wing end assembly

704_-6630XWAXR \$ 1275.00
One color chassis with white top
7043-9211 top
7049-1193 support rail
704_-9222 modesty
704_-831 b/b/f ped
704_-1182L wing end assembly

704_-6630XXAWR \$ 1483.00
One color chassis with white glass modesty
704_-9211 top
7049-1193 support rail
7049-9223WG glass modesty
704_-831 b/b/f ped
704_-1182L wing end assembly

704_-6630XWAWR \$ 1483.00
White top and glass modesty panel
7043-9211 top
7049-1193 support rail
7049-9223WG glass modesty
704_-831 b/b/f ped
704_-1182L wing end assembly



66" Left Single Pedestal Desk

66W X 30D X 30H
704_-6630XXAXL \$ 1275.00
One color with laminate modesty
704_-9211 top
7049-1193 support rail
704_-9222 modesty
704_-831 b/b/f ped
704_-1182R wing end assembly

704_-6630XWAXL \$ 1275.00
One color chassis with white top
7043-9211 top
7049-1193 support rail
704_-9222 modesty
704_-831 b/b/f ped
704_-1182R wing end assembly

704_-6630XXAWL \$ 1483.00
One color chassis with white glass modesty
704_-9211 top
7049-1193 support rail
7049-9223WG modesty
704_-831 b/b/f ped
704_-1182R wing end assembly

704_-6630XWAWL \$ 1483.00
White top and glass modesty panel
7043-9211 top
7049-1193 support rail
7049-9223WG modesty
704_-831 b/b/f ped
704_-1182R wing end assembly

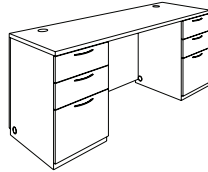

72" Executive Kneespace Credenza

72W X 24D X 30H
704_-7224XXDXD \$ 1559.00
One color with laminate modesty
704_-6201 top
704_-8222 modesty
704_-834 b/b/f peds (2)

704_-7224XWDXD \$ 1559.00
One color chassis with white top
7043-6201 top
704_-8222 modesty
704_-834 b/b/f peds (2)

704_-7224XXDWD \$ 1773.00
One color with white glass modesty
704_-6201 top
7049-8223WG glass modesty
704_-834 b/b/f peds (2)

704_-7224XWDWD \$ 1773.00
White top and glass modesty panel
7043-6201 top
7049-8223WG glass modesty
704_-834 b/b/f peds (2)

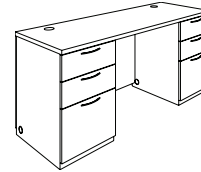

66" Junior Executive Kneespace Credenza

66W X 24D X 30H
704_-6624XXDXD \$ 1497.00
One color with laminate modesty
704_-6202 top
704_-9222 modesty
704_-834 b/b/f peds (2)

704_-6624XWDXD \$ 1497.00
One color chassis with white top
7043-6202 top
704_-9222 modesty
704_-834 b/b/f peds (2)

704_-6624XXDWD \$ 1705.00
One color with white glass modesty
704_-6202 top
7049-9223WG glass modesty
704_-834 b/b/f peds (2)

704_-6624XWDWD \$ 1705.00
White top and glass modesty panel
7043-6202 top
7049-9223WG glass modesty
704_-834 b/b/f peds (2)

*White Laminate Finish available on select pieces



DMI COLLECTION

7040 Mocha / 7041 Honey Maple / 7042 Mahogany / 7043 White* / 7047 Walnut Finishes



72" Right/Left Single Pedestal Credenza
72W X 24D X 30H
704_-7224XXAXX \$ 1167.00
One color with laminate modesty
704_-6201 top
7049-1192 support rail
704_-4223 modesty
704_-834 b/b/f ped
704_-1172 wing end assembly

704_-7224XWAXX \$ 1167.00
One color chassis with white top
7043-6201 top
7049-1192 support rail
704_-4223 modesty
704_-834 b/b/f ped
704_-1172 wing end assembly

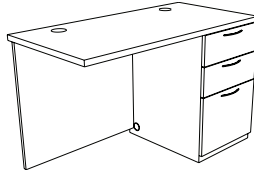

48" Right/Left Single Pedestal Return
48W X 24D X 30H
704_-4824XXAXX \$ 864.00
One color with laminate modesty
704_-6203 top
704_-9222 modesty
704_-834 b/b/f ped

704_-4824XWAXX \$ 864.00
One color chassis with white top
7043-6203 top
704_-9222 modesty
704_-834 b/b/f ped

704_-4824XXAWX \$ 1072.00
One color with white glass modesty
704_-6203 top
7049-9223WG glass modesty
704_-834 b/b/f ped

704_-4824XWAWX \$ 1072.00
White top and glass modesty panel
7043-6203 top
7049-9223WG glass modesty
704_-834 b/b/f ped

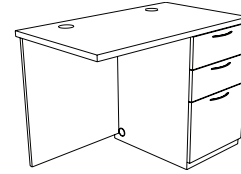

42" Right/Left Single Pedestal Return
42W X 24D X 30H
704_-4224XXAXX \$ 828.00
One color with laminate modesty
704_-6205 top
704_-6223 modesty
704_-834 b/b/f ped

704_-4224XWAXX \$ 828.00
One color chassis with white top
7043-6205 top
704_-6223 modesty
704_-834 b/b/f ped

704_-4224XXAWX \$ 986.00
One color with white glass modesty
704_-6205 top
7049-6223WG glass modesty
704_-834 b/b/f ped

704_-4224XWAWX \$ 986.00
White top and glass modesty panel
7043-6205 top
7049-6223WG glass modesty
704_-834 b/b/f ped

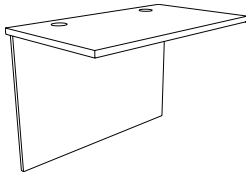

48" Bridge
48W X 24D X 30H
704_-4824XXXXX \$ 415.00
One color with laminate modesty
704_-6203 top
7049-1193 support rail
704_-5223 modesty

704_-4824XWXXX \$ 415.00
One color chassis with white top
7043-6203 top
7049-1193 support rail
704_-5223 modesty

704_-4824XXWXX \$ 715.00
One color chassis with white glass modesty
704_-6203 top
7049-1193 support rail
7049-5223WG glass modesty

7043-4824XWXX \$ 715.00
White top and glass modesty panel
7043-6203 top
7049-1193 support rail
7049-5223WG glass modesty

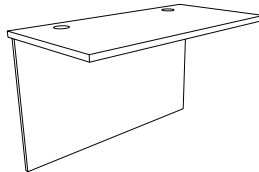

42" Bridge
42W X 24D X 30H
704_-4224XXXXX \$ 322.00
One color with laminate modesty
704_-6205 top
704_-3223 modesty

704_-4224XWXXX \$ 322.00
One color chassis with white top
7043-6205 top
704_-3223 modesty

704_-4224XXWXX \$ 584.00
One color with white glass modesty
704_-6205 top
7049-3223WG glass modesty

7043-4224XWXX \$ 584.00
White top and glass modesty panel
7043-6205 top
7049-3223WG glass modesty

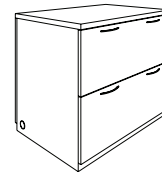

Lateral Files
36W X 24D X 30H
704_-3624XXGXX \$ 975.00
One color laminate
704_-8271 top
704_-161 lateral file pedestal

704_-3624XWGXX \$ 975.00
One color chassis with white top
7043-8271 top
704_-161 lateral file pedestal

*White Laminate Finish available on select pieces

Causeway LAMINATE COLLECTION



FLEXSTEEL®
CONTRACT

7040 Mocha / 7041 Honey Maple / 7042 Mahogany / 7043 White* / 7047 Walnut Finishes

DMI COLLECTION

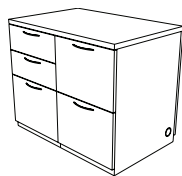

Personal Files

36W X 24D X 30H
704_-3624XXCXX \$ 1280.00

One color laminate
704_-8271 top
704_-834 b/b/f ped
704_-833 f/f ped

704_-3624XWCXX \$ 1280.00

One color chassis with white top
7043-8271 top
704_-834 b/b/f ped
704_-833 f/f ped

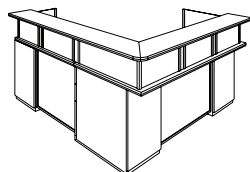

72" Reception Desk with Glass Modesty Panels

75W X 87D X 42.25H
72" Right Reception L Desk (shown)
704_-72RRLD \$ 3921.00
704_-7211L left reception desk top
704_-7203R right reception return top
7049-1192 support rail
7049-8223WG desk glass modesty panel
7049-9223WG return glass modesty panel
704_-831 b/b/f pedestal for desk
704_-834 b/b/f pedestal for return
704_-1182R desk wing end assembly
704_-304L reception l desk riser tops
7049-3041 aluminum framed white glass risers
704_-40 organizers (2)

72" Left Reception L Desk

704_-72LRLD \$ 3921.00
704_-7211R right reception desk top
704_-7203L left reception return top
7049-1192 support rail
7049-8223WG desk glass modesty panel
7049-9223WG return glass modesty panel
704_-831 b/b/f pedestal for desk
704_-834 b/b/f pedestal for return
704_-1182L desk wing end assembly
704_-304R reception l desk riser tops
7049-3041 aluminum framed white glass risers
704_-40 organizers (2)

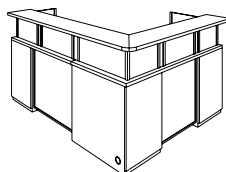

60" Reception Desk with Glass Modesty Panels

63W X 81D X 42.25H
60" Right Reception L Desk (shown)
704_-60RRLD \$ 3362.00
704_-5211L left reception desk top
704_-7203R right reception return top
7049-6223WG desk glass modesty panel
7049-9223WG return glass modesty panel
704_-831 b/b/f pedestal for desk
704_-834 b/b/f pedestal for return
704_-1182R desk wing end assembly
704_-303L reception l desk riser tops
7049-3031 aluminum framed white glass risers

60" Left Reception L Desk

704_-60LRLD \$ 3362.00
704_-5211R right reception desk top
704_-7203L right reception return top
7049-6223WG desk glass modesty panel
7049-9223WG return glass modesty panel
704_-831 b/b/f pedestal for desk
704_-834 b/b/f pedestal for return
704_-1182L desk wing end assembly
704_-303R reception l desk riser tops
7049-3031 aluminum framed white glass risers

*Optional Organizer 704_-40 available for Reception Desks

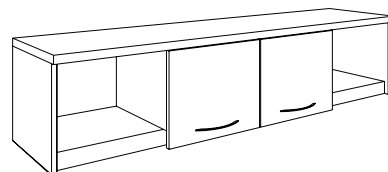

Wall Overhead with Laminate Doors

72" Wall Overhead
72W x 16D x 16.25H
704_-72WO \$ 645.00
704_-404 cabinet
704_-4046 laminate doors

66" Wall Overhead
66W x 16D x 16.25H
704_-66WO \$ 592.00
704_-403 cabinet
704_-4036 laminate doors

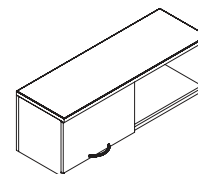

48" Wall Overhead with Laminate Door

48W x 16D x 16.25H
704_-48WO \$ 471.00
704_-402 cabinet
704_-4021 laminate door48

*White Laminate Finish available on select pieces



DMI COLLECTION

7040 Mocha / 7041 Honey Maple / 7042 Mahogany / 7043 White* / 7047 Walnut Finishes

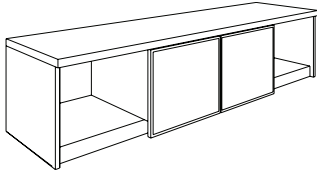

Wall Overhead with Glass Doors

72" Wall Overhead
72W x 16D x 16.25H
704_-72WOG \$ 819.00
704_-404 cabinet
7049-4046WG white glass doors

66" Wall Overhead
66W x 16D x 16.25H
704_-66WOG \$ 767.00
704_-403 cabinet
7049-4036WG white glass doors

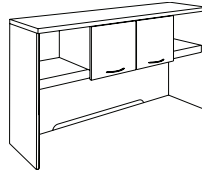

Overhead with Laminate Doors

72" Overhead
72W x 16D x 36H
704_-72O \$ 739.00
704_-62 cabinet
704_-4046 laminate doors

66" Overhead
66W x 16D x 36H
704_-66O \$ 707.00
704_-61 cabinet
704_-4036 laminate doors

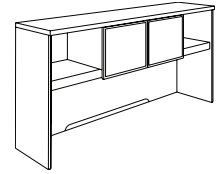

Overhead with Glass Doors

72" Overhead
72W x 16D x 36H
704_-72OG \$ 913.00
704_-62 cabinet
704_-4046WG white glass doors

66" Overhead
66W x 16D x 36H
704_-66OG \$ 882.00
704_-61 cabinet
704_-4036WG white glass doors

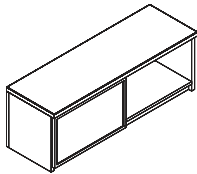

48" Wall Overhead with Glass Door

48W x 16D x 16.25H
704_-48WOG \$ 578.00
704_-402 cabinet
7049-4021WG white glass door

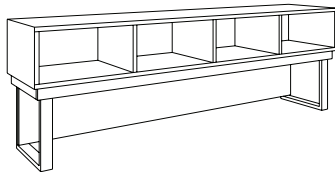

Deck Storage

72" Deck Storage
72W x 16D x 25H
704_-72DS \$ 811.00
704_-1107 deck
7049-111 support frame
704_-110712 deck back panel

66" Deck Storage
66W x 16D x 25H
704_-66DS \$ 796.00
704_-1106 deck
7049-111 support frame
704_-110612 deck back panel

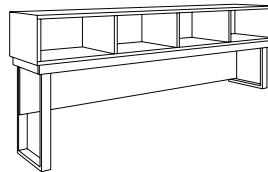

Deck Storage for Benching Applications

72" Deck Storage for Benching Applications
72W x 16D x 35H
704_-72BDS \$ 822.00
704_-1107 deck
7049-110 benching support frame
704_-110712 deck back panel

66" Deck Storage for Benching Applications
66W x 16D x 35H
704_-66BDS \$ 807.00
704_-1106 deck
7049-110 support frame
704_-110612 deck back panel

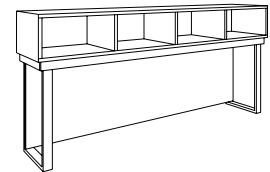

Deck Storage for Benching Applications

72" Deck Storage for Benching Applications
72W x 16D x 35H
704_-72DDS \$ 952.00
704_-1107 deck
7049-109 benching support frame
704_-110722 deck back panel

66" Deck Storage for Benching Applications
66W x 16D x 35H
704_-66DDS \$ 937.00
704_-1106 deck
7049-109 benching support frame
704_-110622 deck back panel

*White Laminate Finish available on select pieces



Causeway LAMINATE COLLECTION



FLEXSTEEL®
CONTRACT

7040 Mocha / 7041 Honey Maple / 7042 Mahogany / 7043 White* / 7047 Walnut Finishes

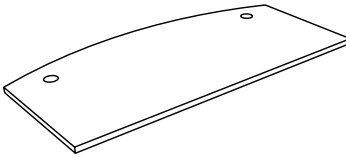
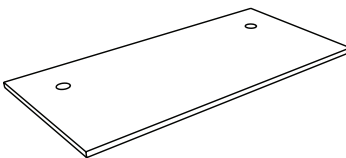
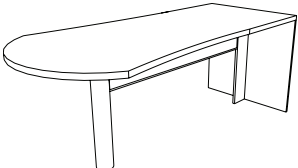
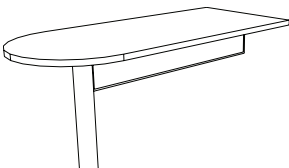
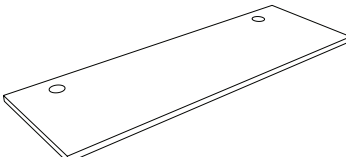
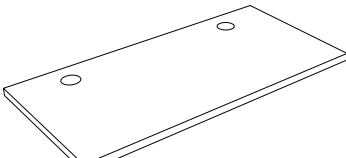
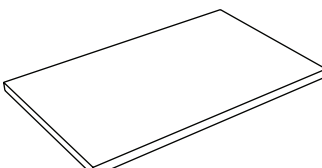
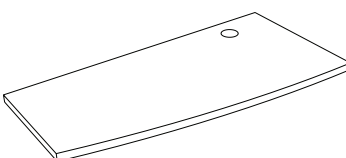
DMI COLLECTION



Item Description	W"	D"	H"	Weight Lbs.	Cubic Ft.	List Price	Features
 <p>72" Bow Front Desk Top 704_-8221</p>	72	36	1.25	84	3.2	\$ 359.00	<ul style="list-style-type: none"> • Two grommets • Finishes: MC, HM, MH, WL, WN • Grommets accommodate optional 0000-38 Hide-A-Dock or 0000-42 Pop-up Station (see Accessories section for details)
 <p>Straight Front Desk Tops 704_-8211 704_-9211 704_-6211</p>	72 66 60	36 30 30	1.25 1.25 1.25	82 66 58	3.2 2.5 2.2	\$ 359.00 \$ 279.00 \$ 257.00	<ul style="list-style-type: none"> • Two grommets • Finishes: MC, HM, MH, WL, WN • Grommets accommodate optional 0000-38 Hide-A-Dock or 0000-42 Pop-up Station (see Accessories section for details)
 <p>72" Fan Shaped Desk 704_-7210 Consists of: -7201 Top, 12" Modesty Panel -7202 End Support Panel 7049-001 Metal Post</p>	72 72	36 36	29.5	172 128 33 11	7.4 4.9 1.4 1.1	\$ 954.00 \$ 723.00 \$ 134.00 \$ 97.00	<ul style="list-style-type: none"> • Framed white glass 12" modesty panel • Finishes: MC, HM, MH, WL, WN
 <p>66" Conference Extension 704_-6210 Consists of: -620 Top, Modesty Panel 7049-001 Metal Post</p>	66 66	30 30	29.5	110 99 11	3.6 2.5 1.1	\$ 595.00 \$ 498.00 \$ 97.00	<ul style="list-style-type: none"> • Includes top, white glass modesty panel, an aluminum frame and a 4" diameter post • Finishes: MC, HM, MH, WL, WN
 <p>Credenza Tops 704_-6201 704_-6202</p>	72 66	24 24	1.25 1.25	60 53	2.2 2.2	\$ 268.00 \$ 252.00	<ul style="list-style-type: none"> • Two grommets • Finishes: MC, HM, MH, WL, WN • Grommets accommodate optional 0000-38 Hide-A-Dock or 0000-42 Pop-up Station (see Accessories section for details)
 <p>Bridge/Return Tops 704_-6203 704_-6205</p>	48 42	24 24	1.25 1.25	42 35	1.4 1.8	\$ 192.00 \$ 161.00	<ul style="list-style-type: none"> • Two grommets • Finishes: MC, HM, MH, WL, WN • Grommets accommodate optional 0000-38 Hide-A-Dock or 0000-42 Pop-up Station (see Accessories section for details)
 <p>Lateral/Personal File Top 704_-8271</p>	36	24	1.25	29	1.1	\$ 134.00	<ul style="list-style-type: none"> • Finishes: MC, HM, MH, WL, WN
 <p>Home Office Tops 704_-6204R 704_-6204L</p>	48 48	18-24 18-24	1.25 1.25	38 38	1.4 1.4	\$ 192.00 \$ 192.00	<ul style="list-style-type: none"> • Finishes: MC, HM, MH, WL, WN • Grommets accommodate optional 0000-38 Hide-A-Dock or 0000-42 Pop-up Station (see Accessories section for details)
 <p>Top Support Rails 7049-1191 7049-1192 7049-1193</p>	60 50 44	12 12 12	1 1 1	15 13 12	5.3 3.8 3.5	\$ 78.00 \$ 68.00 \$ 57.00	<ul style="list-style-type: none"> • Silver painted finish • Use -1191 with 72" tops without pedestals • Use -1192 with 72" tops with one pedestal and both 66" and 60" tops without pedestals • Use -1193 with 66" tops with one pedestal and 48" tops without pedestals

*White Laminate Finish available on select pieces

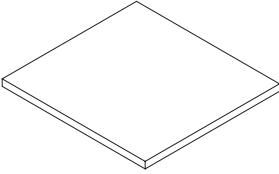
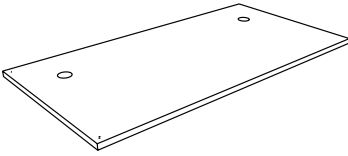
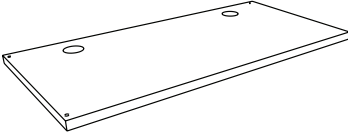
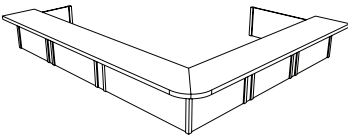
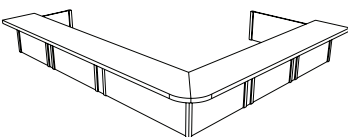

DMI COLLECTION

7040 Mocha / 7041 Honey Maple / 7042 Mahogany / 7043 White* / 7047 Walnut Finishes

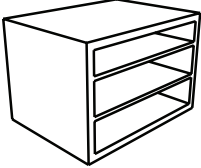
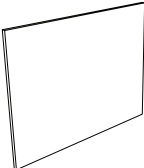

Item Description	Weight	Cubic	List	Features
Model Number	Lbs.	Ft.	Price	
 <p>Optional Laminate Top for Mobile Pedestal 704_-701</p>	9	0.4	\$ 32.00	• Finishes: MC, HM, MH, WL, WN
 <p>Reception Desk Tops 704_-7211R 704_-7211L 704_-5211R 704_-5211L</p>	69 69 55 55	3.2 3.2 2.1 2.1	\$ 307.00 \$ 307.00 \$ 262.00 \$ 262.00	• Two grommets • Finishes: MC, HM, MH, WL, WN • Grommets accommodate optional 0000-38 Hide-A-Dock or 0000-42 Pop-up Station (see Accessories section for details)
 <p>Reception Return Tops 704_-7203R 704_-7203L</p>	40 40	1.4 1.4	\$ 192.00 \$ 192.00	• Two grommets • Finishes: MC, HM, MH, WL, WN • Grommets accommodate optional 0000-38 Hide-A-Dock or 0000-42 Pop-up Station (see Accessories section for details)
 <p>72" Reception Transaction Tops (R/L) 704_-304R 704_-304L 72" Reception Risers 7049-3041</p>	91 91 55	2.1 2.1 1.1	\$ 286.00 \$ 286.00 \$ 749.00	• Top finishes: MC, HM, MH, WL, WN • 7049-3041, 7049-3031 risers are laminate and aluminum framed white glass <i>Must order both top and risers for a complete unit</i>
 <p>60" Reception Transaction Tops (R/L) 704_-303R 704_-303L 60" Reception Risers 7049-3031</p>	77 77 51	2.1 2.1 1.1	\$ 276.00 \$ 276.00 \$ 660.00	
 <p>Double Reception Desk Connector Panel 7049-3051</p>	1	0.1	\$ 12.00	• Use between the right and left desk risers when creating a double reception station
 <p>Organizer for Reception Desks 704_-40</p>	35	0.8	\$ 120.00	• Three letter trays • Finishes: MC, HM, MH, WL, WN
 <p>Laminate Modesty Panels 704_-8222 704_-9222 704_-6223 704_-4223</p>	31 29 16 33	1.1 1.1 0.7 1.8	\$ 145.00 \$ 99.00 \$ 94.00 \$ 166.00	• Finishes: MC, HM, MH, WN • -8222 use with tops -8221, -8211, -6201, -7211, peds/supports -831, -832, -833, -834 -161, -S731, -S734, -1182R/L, -1172 • -9222 use with tops -9211, -6202, -6203 -7203R/L, peds/supports -831, -832, -833, -834, S731, S734, -1181R/L • -6223 use with tops -6211, -6203, -5211, -6205, peds/supports -833, -834, -S731, -S734 • -4223 use with top -6201, pedestals/supports -833, -834, -1172

*White Laminate Finish available on select pieces

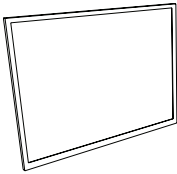
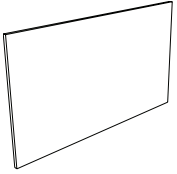
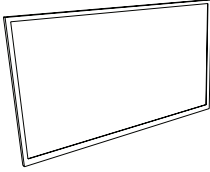
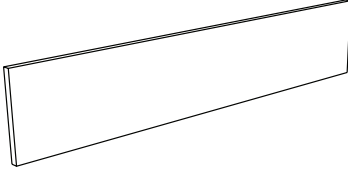
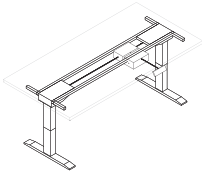

7040 Mocha / 7041 Honey Maple / 7042 Mahogany / 7043 White* / 7047 Walnut Finishes

DMI COLLECTION

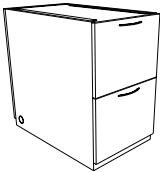
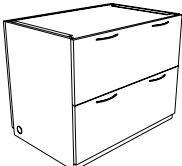

Item Description	W"	D"	H"	Weight Lbs.	Cubic Ft.	List Price	Features
 White Glass Modesty Panels							<ul style="list-style-type: none"> -8223WG use with tops -8221, -8211, -6201, -7211, peds/supports-831, -832, -833, -834 -161, -S731, -S734, -1182R/L, -1172 -9222WG use with tops -9211, -6202, -6203 -7203R/L, peds/supports -831, -832, -833, -834, S731, S734, -1181R/L -6233WG use with tops -6211, -6203, -5211, -6205, peds/supports -833, -834, -S731, -S734
7049-8223WG	36	0.75	27.25	50	1.1	\$ 359.00	
7049-9223WG	30	0.75	27.25	40	1.1	\$ 307.00	
7049-6223WG	24	0.75	27.25	30	0.7	\$ 252.00	
 Laminate Bridge Modesty Panels							<ul style="list-style-type: none"> • Finishes: MC, HM, MH, WN • -5223 use with top -6203 • -3223 use with top -6205
704_-5223	48	0.75	28.75	31	1.4	\$ 166.00	
704_-3223	42	0.75	28.75	31	1.4	\$ 161.00	
 White Glass Bridge Modesty Panels							<ul style="list-style-type: none"> • -5223WG use with top -6203 • -3223WG use with top -6205
7049-5223WG	48	0.75	28.75	49	1.4	\$ 466.00	
7049-3223WG	42	0.75	28.75	42	1.4	\$ 423.00	
 Small Office/Home Office Modesty Panel							<ul style="list-style-type: none"> • Finishes: MC, HM, MH, WL, WN • -6224 with 60" top (40" modesty used with ped and metal end support frame -5902) • -6225 with 66" top (46" modesty used with ped and metal end support frame -5902) • -6226 with 72" top (52" modesty used with ped and metal end support frame -5902) • -7222 with 60" top (50" modesty used with ped and metal end support frame -5902) • -7223 with 48" top (44" modesty used with 2 metal end support frames -5902) • -7224 with 60" top (56" modesty used with 2 metal end support frames -5902) • -7225 with 66" top (62" modesty used with 2 metal end support frames -5902) • -7226 with 72" top (68" modesty used with 2 metal end support frames -5902)
704_-6224	40	0.75	8.75	10	0.7	\$ 97.00	
704_-6225	46	0.75	8.75	11	0.7	\$ 97.00	
704_-6226	52	0.75	8.75	12	0.7	\$ 107.00	
704_-7222	50	0.75	8.75	10	0.7	\$ 94.00	
704_-7223	44	0.75	8.75	11	0.7	\$ 94.00	
704_-7224	56	0.75	8.75	13	0.7	\$ 107.00	
704_-7225	62	0.75	8.75	14	0.7	\$ 118.00	
704_-7226	68	0.75	8.75	14	0.9	\$ 118.00	
 Sit To Stand Desk Base							<ul style="list-style-type: none"> • Adjustable width and height • Finished in grey metal • Base fits desk tops -8211, -9211, -6211, -6201, -6202, -6203
7099-AB	57-76.75	26.75-43.25		72	3.5	\$ 1130.00	
Consists of:							
7099-AB1 Table Base				42	2.6	\$ 960.00	
7099-AB2 Motor and Tray				30	0.9	\$ 170.00	
 Box/Box/File Pedestals							<ul style="list-style-type: none"> • Finishes: MC, HM, MH, WN • -831 use with 36" & 30" deep work surfaces • -834 use with 24" deep work surfaces • Pencil tray in top drawer • Central locking • Cable accessible • Pedestals ship set-up
704_-831	18	30	28.75	99	13.1	\$ 670.00	
704_-834	18	24	28.75	86	11.0	\$ 573.00	
 File/File Pedestals							<ul style="list-style-type: none"> • Finishes: MC, HM, MH, WN • -832 use with 36" & 30" deep work surfaces • -833 use with 24" deep work surfaces • Central locking • Cable accessible • Pedestals ship set-up
704_-832	18	30	28.75	97	13.1	\$ 670.00	
704_-833	18	24	28.75	75	11.0	\$ 573.00	
 Lateral File Pedestal							<ul style="list-style-type: none"> • Finishes: MC, HM, MH, WN • Two file drawers • Central locking • Anti-tip device • Cable accessible • Pedestal ship set-up
704_-161	36	24	28.75	119	19.8	\$ 841.00	

*White Laminate Finish available on select pieces

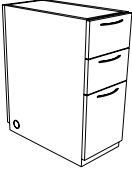
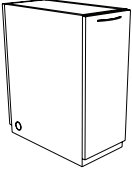

DMI COLLECTION

7040 Mocha / 7041 Honey Maple / 7042 Mahogany / 7043 White* / 7047 Walnut Finishes

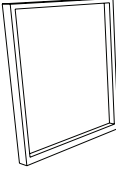
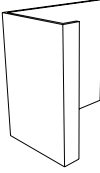
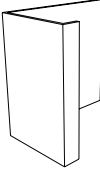
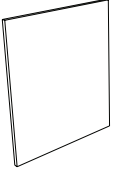
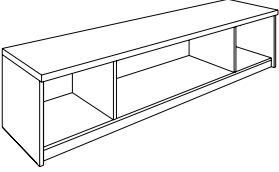
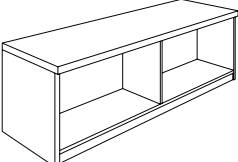
Item Description Model Number	W"	D"	H"	Weight Lbs.	Cubic Ft.	List Price	Features
	Box/Box/File Home Office Pedestal						
	704_-S731	12	24	28.75	64	7.8	\$ 483.00
	704_-S531	12	18	28.75	55	6.0	\$ 423.00
	Door Home Office Pedestal						
	704_-S734	12	24	28.75	55	7.8	\$ 337.00
	Box/File Mobile Pedestal						
	704_-70	18	18	23	77	6.7	\$ 494.00
	Box/Box/File Mobile Pedestal						
	704_-71	18	18	29	77	6.7	\$ 589.00
	White Glass Support Insert						
	7049-5901WG	20.75	1	25.5	13	0.6	\$ 239.00
	7049-5911WG	28	1	26.75	14	0.1	\$ 256.00
	End Support Frame						
	7049-5902						
	7049-5912						
	Desk Wing End Assemblies						
	704_-1182R						
	704_-1182L						
	Credenza End Panel/Wing End						
	704_-1172	23.25	0.75	28.75	20	0.7	\$ 92.00
	Wall Cabinet Case						
	704_-404						
	704_-403						
	48" Wall Cabinet Case						
	704_-402						

- Finishes: MC, HM, MH, WN
- Pencil tray in top drawer
- Central locking
- Cable accessible
- Pedestals ship set-up

- Finishes: MC, HM, MH, WN
- Adjustable shelf
- Cable accessible
- Pedestal ship set-up

- Finishes: MC, HM, MH, WN
- White vinyl cushion top
- Pencil tray in top drawer
- Rests on casters for convenient mobility
- Cable accessible
- Optional laminate top -701 available, listed under top components
- Pedestal ship set-up

- Finishes: MC, HM, MH, WN
- White vinyl cushion top
- Pencil tray in top drawer
- Rests on casters for convenient mobility
- Cable accessible
- Optional laminate top -701 available, listed under top components
- Pedestal ship set-up

- -5901WG & -5902 for use with -6201, -6202, -6203, -6204R, -6204L, -6205 tops
- -5911WG & -5912 for use with -6211, -8211, -9211

- Finishes: MC, HM, MH, WN

- Finishes: MC, HM, MH, WN
- Use with -8222, -9222, -6223, -4223, -5223, -3223

- Finishes: MC, HM, MH, WN
 - Divided cabinet; 16" black, swivel task light
- Doors and cabinets are ordered individually*

- Finishes: MC, HM, MH, WN
 - Divided interior; low profile black task light
- Doors and cabinets are ordered individually*

*White Laminate Finish available on select pieces

Causeway LAMINATE COLLECTION



FLEXSTEEL®
CONTRACT

7040 Mocha / 7041 Honey Maple / 7042 Mahogany / 7043 White* / 7047 Walnut Finishes

DMI COLLECTION

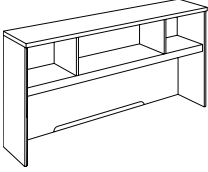
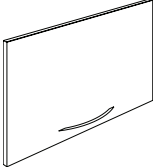
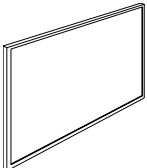
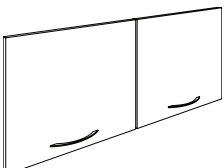
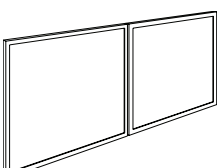
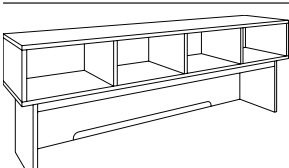
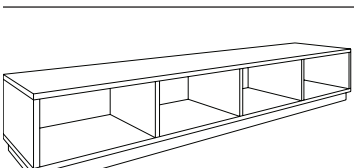
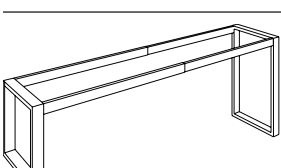
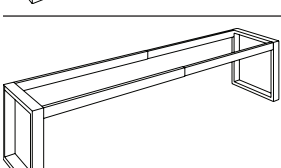

Item Description Model Number	W"	D"	H"	Weight Lbs.	Cubic Ft.	List Price	List Price	Features
 Overhead Case 704_-62 704_-61	72	16	36	134	5.7	\$ 619.00		<ul style="list-style-type: none"> • Finishes: MC, HM, MH, WN • Divided cabinet, cable accessible
	66	16	36	125	4.6	\$ 598.00		Doors and cabinets are ordered individually
 Laminate Doors for 48" Wall Cabinet 704_-4021				9	0.7	\$ 80.00		<ul style="list-style-type: none"> • Finishes: MC, HM, MH, WN • One sliding door
Doors and cabinets are ordered individually								
 White Glass Doors for 48" Wall Cabinet 7049-4021WG				11	0.7	\$ 187.00		<ul style="list-style-type: none"> • Aluminum framed, white glass doors • White glass door options do not have pulls • One sliding door
Doors and cabinets are ordered individually								
 Laminate Doors for Overhead/Wall Cabinet 704_-4046 704_-4036				13	0.7	\$ 120.00		<ul style="list-style-type: none"> • Finishes: MC, HM, MH, WN • Two sliding doors • -4046 for use with 72" overhead/wall cabinet • -4036 for use with 66" overhead/wall cabinet
				11	0.7	\$ 109.00		
 White Glass Doors for 48" Wall Cabinet 7049-4046WG 7049-4036WG				18	1.1	\$ 294.00		<ul style="list-style-type: none"> • Aluminum framed, white glass doors • White glass door options do not have pulls • Two sliding doors • -4046WG for use with 72" overhead/wall cabinet • -4036WG for use with 66" overhead/wall cabinet
				16	1.1	\$ 284.00		
 Desk Deck 704_-173 704_-163	72	16	24	110	3.2	\$ 456.00		<ul style="list-style-type: none"> • Finishes: MC, HM, MH, WL, WN • Four pigeon hole compartments
	66	16	24	103	3.6	\$ 423.00		
 Hanging/Deck Storage 704_-1107 704_-1106	72	16	12	121	3.6	\$ 401.00		<ul style="list-style-type: none"> • Finishes: MC, HM, MH, WL, WN • Can be used for deck storage with 7049-110, -109, -111 support frame • Wall mountable Z-rails
	66	16	12	111	3.3	\$ 386.00		
 Deck Storage Support Frame 7049-110	46-65	13.75	14-23.75	28	1.7	\$ 327.00		<ul style="list-style-type: none"> • Designed to be used with -1106 or -1107 storage • Adjustable width • One 14" and one 23" height for benching applications
 Deck Storage Support Frame 7049-109 7049-111	46-65	13.75	23.75	33	2.5	\$ 390.00		<ul style="list-style-type: none"> • Designed to be used with -1106 or -1107 storage • Designed to be used for surfaces with same height • -109 has 23.75" frame ends • -111 has 14" frame ends • Adjustable width
	46-65	13.75	14	25	1.7	\$ 316.00		

*White Laminate Finish available on select pieces

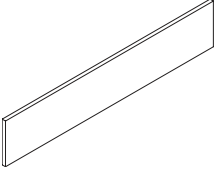
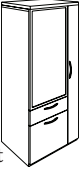
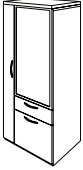
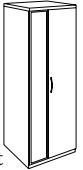
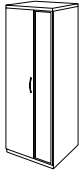

DMI COLLECTION

7040 Mocha / 7041 Honey Maple / 7042 Mahogany / 7043 White* / 7047 Walnut Finishes

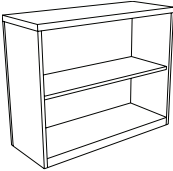
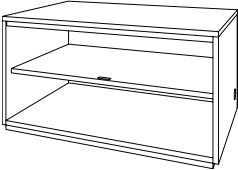
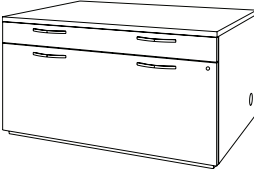
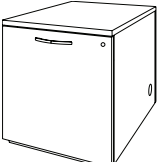
		Item Description	W"	D"	H"	Weight	Cubic	List	
		Model Number				Lbs.	Ft.	Price	Features
		Deck Back Panel							
		704_-110612	63	1	12	16	0.9	\$ 94.00	• Finishes: MC, HM, MH, WN
		704_-110712	69	1	12	17	0.9	\$ 94.00	• -110612 use with -403, -110, -111, -1106
		704_-40212	48	1	12	12	0.6	\$ 68.00	• -110712 use with -404, -110, -111, -1107
		704_-110622	63	1	21.75	21	1.4	\$ 161.00	• -40212 use with -402, -110, -111
		704_-110722	69	1	21.75	22	1.6	\$ 161.00	• -110622 use with -403, -109, -1106
	704_-40222	48	1	21.75	19	1.1	\$ 120.00	• -110722 use with -404, -109, -1107	
									• -40222 use with -402, -109
Right 		Right Hand Facing Mini Tower Cabinet	24	18	54	180	19.1	\$ 1159.00	<ul style="list-style-type: none"> • Finishes: MC, HM, MH, WN • Box drawer; locking file drawer; cabinet with two adjustable shelves; aluminum framed white glass door cabinet (above drawers) with a coat hook and three adjustable shelves • Cable accessible
		704_-03RH							
Left 		Left Hand Facing Mini Tower Cabinet	24	18	54	180	19.1	\$ 1159.00	
Right 		Right Hand Facing Wardrobe Cabinet	24	24	66	213	29.67	\$ 1345.00	<ul style="list-style-type: none"> • Finishes: MC, HM, MH, WN • Two door cabinet, smaller door has white glass panel, touch hinge operated wardrobe cabinet with a hanger rod, a coat hook and four adjustable shelves
		704_-08RH							
Left 		Left Hand Facing Wardrobe Cabinet	24	24	66	213	29.67	\$ 1345.00	
		54" Bookcase	36	14	54	123	4.6	\$ 530.00	<ul style="list-style-type: none"> • Finishes: MC, HM, MH, WN • Three adjustable shelves
		704_-158							
		36" Bookcase	36	14	36	84	3.5	\$ 391.00	<ul style="list-style-type: none"> • Finishes: MC, HM, MH, WN • Two adjustable shelves
		704_-148							
		30" Bookcase	36	14	30	75	2.8	\$ 294.00	<ul style="list-style-type: none"> • Finishes: MC, HM, MH, WN • One adjustable shelf • For use as a freestanding bookcase or atop the lateral file
		704_-138							
		Bench Height Pedestal	36	24	20	128	14.1	\$ 619.00	<ul style="list-style-type: none"> • Two pull-out shelves with back stops • Engineered for stacking or stand alone use • Tops are removable to support stacking • Adjustable glides • Cable accessible • Cushions available • Ships set-up
		7043-S837							
		Bench Height Box/Lateral File Pedestal	36	24	20	176	14.1	\$ 825.00	<ul style="list-style-type: none"> • Box / locking lateral file drawer • Box drawer has pencil tray • Engineered for stacking or stand alone use • Tops are removable to support stacking • Adjustable glides • Cable accessible • Cushions available • Ships set-up
		7043-S827							
		Right Bench Height Door Pedestal	18	24	20	88	7.7	\$ 391.00	<ul style="list-style-type: none"> • Locking cabinet with one adjustable shelf • Engineered for stacking or stand alone use • Tops are removable to support stacking • Adjustable glides • Cable accessible • Cushions available • Ships set-up
		7043-S834R							
		Left Bench Height Door Pedestal	18	24	20	88	7.7	\$ 391.00	
		7043-S834L							

*White Laminate Finish available on select pieces

Causeway LAMINATE COLLECTION



FLEXSTEEL®
CONTRACT

7040 Mocha / 7041 Honey Maple / 7042 Mahogany / 7043 White* / 7047 Walnut Finishes

DMI COLLECTION

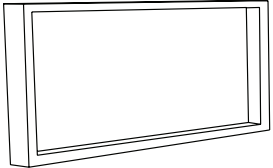
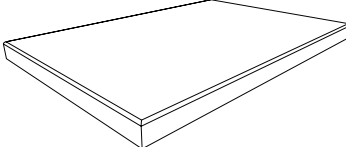
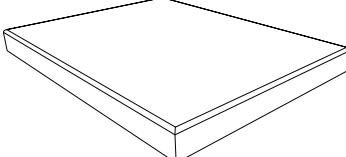
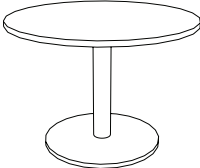
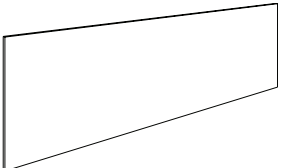
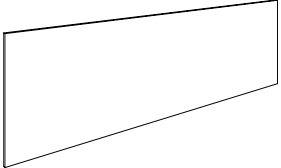
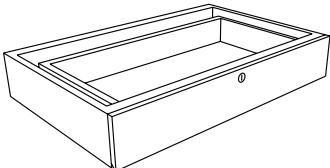
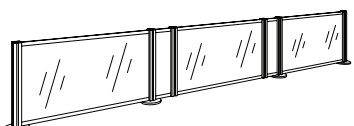

Item Description	W"	D"	H"	Weight Lbs.	Cubic Ft.	List Price	Features
 <p>Bench Height Box/File Pedestal 7043-S838</p>	18	24	20	88.0	7.7	\$ 509.00	<ul style="list-style-type: none"> • Box / locking file drawer • Box drawer has pencil tray • Engineered for stacking or stand alone use • Tops are removable to support stacking • Adjustable glides • Cushions available • Cushions available • Ships set-up
 <p>Bench Wing End Support Frame 7049-1162</p>	24	4	8.75	28	5.3	\$ 161.00	<ul style="list-style-type: none"> • Can be used with -6201, -6202, -6203, -6205, -6211, -8211, -9211 or a 24" deep worksurface
 <p>36" Bench Cushions</p>							
7049-36BC-SC01	36	24	2	6	1.0	\$ 172.00	• -SC01 Scena/Desert
7049-36BC-SC02	36	24	2	6	1.0	\$ 172.00	• -SC02 Scena/Highway
7049-36BC-SC05	36	24	2	6	1.0	\$ 172.00	• -SC05 Scena/Palace
7049-36BC-SC07	36	24	2	6	1.0	\$ 172.00	• -SC07 Scena/Coral Reef
7049-36BC-SC17	36	24	2	6	1.0	\$ 172.00	• -SC17 Scena/Ocean
 <p>18" Bench Cushions</p>							
7049-18BC-SC01	18	24	2	3	0.6	\$ 99.00	• -SC01 Scena/Desert
7049-18BC-SC02	18	24	2	3	0.6	\$ 99.00	• -SC02 Scena/Highway
7049-18BC-SC05	18	24	2	3	0.6	\$ 99.00	• -SC05 Scena/Palace
7049-18BC-SC07	18	24	2	3	0.6	\$ 99.00	• -SC07 Scena/Coral Reef
7049-18BC-SC17	18	24	2	3	0.6	\$ 99.00	• -SC17 Scena/Ocean
 <p>42" Round Conference Table</p>							
704_-011	42	42	1.25	57	2.1	\$ 252.00	• Finishes: MC, HM, MH, WL, WN
7049-002	25	25	27.5	86	13.1	\$ 804.00	• 42" diameter top • 28" diameter base with 4" diameter aluminum finished post
 <p>Reversible Tackboards</p>							
7049-101	36	0.5	18	26	0.7	\$ 140.00	• -101 for use with 72" overheads
7049-103	30	0.5	18	22	0.7	\$ 112.00	• -103 for use with 66" overheads
7049-104	36	0.5	11	10	0.1	\$ 107.00	• -104 for use with deck storage -173, -163 • Reversible with black on one side and white on other side
 <p>Markerboards</p>							
7049-901	36	0.5	18	20	0.7	\$ 219.00	• -901 for use with 72" overheads
7049-903	30	0.5	18	18	0.7	\$ 182.00	• -903 for use with 66" overheads
 <p>Optional Center Drawer 704_-73</p>	24	15.25	4	15	2.1	\$ 145.00	<ul style="list-style-type: none"> • Finishes: MC, HM, MH, WL, WN • Ball bearing slides • Black vinyl wrapped interior
 <p>Divider/Privacy Screen 7049-113</p>	71.25	1	11	42	1.9	\$ 466.00	<ul style="list-style-type: none"> • Standard with white acrylic panels • Use on 72" worksurfaces

*White Laminate Finish available on select pieces

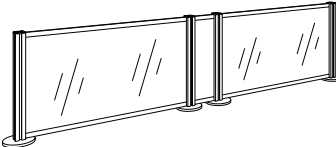
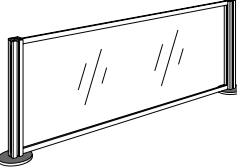
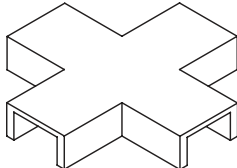
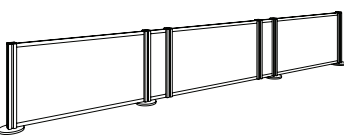
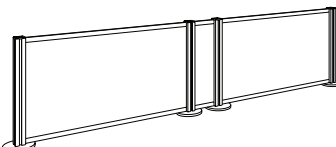
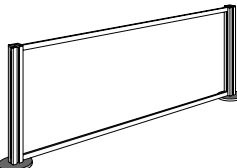
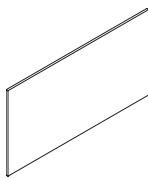

DMI COLLECTION

7040 Mocha / 7041 Honey Maple / 7042 Mahogany / 7043 White* / 7047 Walnut Finishes

Item Description	W"	D"	H"	Weight	Cubic	List	Features
Model Number				Lbs.	Ft.	Price	
 Divider/Privacy Screen							<ul style="list-style-type: none"> Standard with white acrylic panels -116 use on 60", 66" surfaces -118 use on 48" surfaces
7049-116	59.25	1	11	34	1.4	\$ 364.00	
7049-118	45.25	1	11	2	0.1	\$ 285.00	
 Divider/Privacy Screen							<ul style="list-style-type: none"> Standard with white acrylic panels -112 use on 36" surfaces -121 use on 30" surfaces -123 use on 24" deep surfaces
7049-112	32.25	1	11	20	1.1	\$ 187.00	
7049-121	29.25	1	11	22	0.1	\$ 164.00	
7049-123	23.25	1	11	15	0.1	\$ 140.00	
 Connector							<ul style="list-style-type: none"> Use to connect privacy frames in the quad configuration
0000-901	3	3	.5	1	0.3	\$ 14.00	
 Divider/Privacy Screen Frame							<ul style="list-style-type: none"> Aluminum frame only; requires inserts Use on 72" worksurfaces -115 requires three 20" inserts and one 5" insert set -115 if mixing inserts, must specify location for 20" panels
7049-115	71.25	1	11	36	1.6	\$ 214.00	
 Divider/Privacy Screen Frame							<ul style="list-style-type: none"> Aluminum frame only; requires inserts -117 use on 60", 66" surfaces -119 use on 48" surfaces
7049-117	59.25	1	11	30	1.3	\$ 198.00	
7049-119	45.25	1	11	3	0.1	\$ 159.00	
 Divider/Privacy Screen Frame							<ul style="list-style-type: none"> Aluminum frame only; requires inserts -114 use on 36" surfaces -122 use on 30" surfaces -124 use on 24" deep surfaces
7049-114	32.25	1	11	17.0	1.1	\$ 92.00	
7049-122	29.25	1	11	16	0.1	\$ 92.00	
7049-124	23.25	1	11	12	0.1	\$ 84.00	
 20" Divider/Privacy Screen Frame Inserts							<ul style="list-style-type: none"> -TBB black tackboard insert -TBW white tackboard insert -92 white 2 sided acrylic insert -011 frosted 2 sided insert -28L oyster linen insert -28A aero linen insert -28M micro cirque linen insert -042 silver spun insert
7049-TBB20	17	1	11	5	0.1	\$ 80.00	
7049-TBW20	17	1	11	5	0.1	\$ 80.00	
7049-00920	17	1	11	5	0.1	\$ 105.00	
7049-01120	17	1	11	5	0.1	\$ 123.00	
7049-28L20	17	1	11	5	0.1	\$ 276.00	
7049-28A20	17	1	11	5	0.1	\$ 276.00	
7049-28M20	17	1	11	8	0.1	\$ 276.00	
7049-04220	17	1	11	5	0.1	\$ 401.00	
 5" Divider/Privacy Screen Frame Inserts							<ul style="list-style-type: none"> Set includes 2 inserts -92 white 2 sided acrylic insert -011 frosted 2 sided insert -28L oyster linen insert -28A aero linen insert -28M micro cirque linen insert -042 silver spun insert
7049-00905	3	1	11	1	0.1	\$ 52.00	
7049-01105	3	1	11	1	0.1	\$ 62.00	
7049-28L05	3	1	11	1	0.1	\$ 137.00	
7049-28A05	3	1	11	1	0.3	\$ 137.00	
7049-28M05	3	1	11	1	0.3	\$ 137.00	
7049-04205	3	1	11	1	0.1	\$ 200.00	

*White Laminate Finish available on select pieces



7040 Mocha / 7041 Honey Maple / 7042 Mahogany / 7043 White* / 7047 Walnut Finishes

DMI COLLECTION

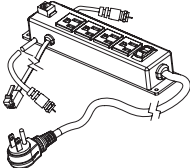
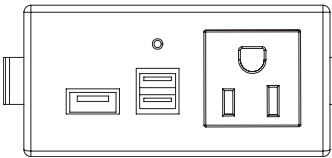
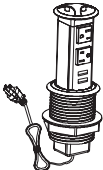
Item Description Model Number	W"	D"	H"	Weight Lbs.	Cubic Ft.	List		
						Price	Features	
30" Divider/Privacy Screen Frame Inserts								
7049-TBB30	28	1	11	7	0.2	\$	177.00	• -TBB black tackboard insert
7049-TBW30	28	1	11	7	0.2	\$	177.00	• -TBW white tackboard insert
7049-00930	28	1	11	7	0.2	\$	172.00	• -92 white 2 sided acrylic insert
7049-01130	28	1	11	7	0.2	\$	199.00	• -011 frosted 2 sided insert
7049-28L30	28	1	11	7	0.2	\$	412.00	• -28L oyster linen insert
7049-28A30	28	1	11	7	0.2	\$	412.00	• -28A aero linen insert
7049-28M30	28	1	11	7	0.2	\$	412.00	• -28M micro cirque linen insert
7049-04230	28	1	11	7	0.2	\$	590.00	• -042 silver spun insert
<hr/>								
 Hide-A-Dock 0000-38	3.5	2.5	2.75	2	0.1	\$	113.00	<ul style="list-style-type: none"> • Black with flip-lid top • Three USB 2.0 ports with a total of 2A power, card reader with SD/SDHC/MMC, MS Pro/Duo slots, External audio jack, 100-240V AC/DC 2A adapter, 6' digital cable, combined 3.5mm headphone/microphone jack and USB type A jack • Designed for easy grommet hole installation
 TVS4113 0000-40	7.5	2	1.5	2	0.2	\$	82.00	<ul style="list-style-type: none"> • Black four power outlets, phone jack with phone cable, TV cable • AC125V 12A 60Hz rating • Overload protect switch with indicator light • SJT 14AWG/3C power cord • Factory installation not available. Includes hardware for attachment to desired location.
 PC710 0000-41				2	0.2	\$	77.00	<ul style="list-style-type: none"> • Black, one AC grounded outlet, one USB pass through, two USB chargers per DCSV IA • AC 125V 60Hz 10A rating • 8' 16AWGX3C power cord with ground plug
Installation for Unit 0000-0099						\$	452.00	<ul style="list-style-type: none"> • Note: Orders for installations cannot be cancelled
 Pop-Up Power Station 0000-42	3.5	3.5	10	3	0.4	\$	135.00	<ul style="list-style-type: none"> • Black, two outlets, two DCSV 2.14 USB ports • AC 125V 60Hz, 12A max rating • 6' SJT 14AWG/3C power cord • Designed for easy grommet hole installation • Requires minimum 12" clearance under mounted surface for correct operation

*White Laminate Finish available on select pieces



Fairplex

LAMINATE COLLECTION

7003 Grey / 7004 Mocha / 7005 Cognac Cherry / 7006 Mahogany / 7007 Walnut Finishes

Crisp edges accentuate a minimalist design.

With a clean and simple aesthetic, the Fairplex Collection helps you create a workspace free from visual clutter. Featuring reeded-edge tops and five laminate finishes; Grey, Mocha, Cognac Cherry, Mahogany, and Walnut.

Details:

- Construction consists of laminate surfaces on wood product with Cam-lock fasteners, wood dowels, screws and glue
- All top surfaces are 1.125" thick with the TFL surface, reeded edges and wood substraight
- All drawers have full extension, metal ball bearing slides
- All pedestals and the lateral file have a front mounted lock with central locking
- Locking drawers are all keyed the same. If you need specific items keyed differently, please contact your customer service representative
- Box drawers rated for 75 lbs
- File drawers rated for 150 lbs
- File drawers equipped with metal rods for letter or legal sized hanging files
- Adjustable floor levelers



FLEXSTEEL®
CONTRACT

DMI COLLECTION







Fairplex LAMINATE COLLECTION

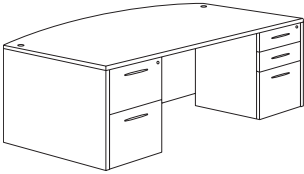

FLEXSTEEL®
CONTRACT

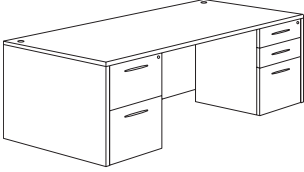
7003 Grey / 7004 Mocha / 7005 Cognac Cherry / 7006 Mahogany / 7007 Walnut Finishes

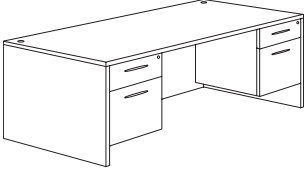

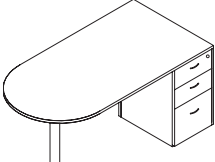

DMI COLLECTION

Item Description	W"	D"	H"	Weight Lbs.	Cubic Ft.	List Price	Features
 Executive Bow Front Desk 700_-37	71	41.25	29	325	25.0	\$ 1249.00	<ul style="list-style-type: none"> • Locking box/box/file pedestal • Locking file/file pedestal • Pedestals ship set-up • Requires assembly
Consists of:							
-822 Desk Shell w/Bow Top	71	41.25	29	173	7.8	\$ 515.00	
-831 B/B/F Pedestal	15.5	22	28	78	8.6	\$ 380.00	
-832 F/F Pedestal	15.5	22	28	74	8.6	\$ 354.00	
 Executive Bow Front Desk with 3/4 Pedestals 700_-37Q	71	41.25	29	295	21.0	\$ 1121.00	<ul style="list-style-type: none"> • Two locking box/file pedestals • Pedestals ship set-up • Requires assembly
Consists of:							
-822 Desk Shell w/Bow Top	71	41.25	29	173	7.8	\$ 515.00	
-838 B/F 3/4 Pedestal	15.5	22.25	20.75	61	6.6	\$ 303.00	
-838 B/F 3/4 Pedestal	15.5	22.25	20.75	61	6.6	\$ 303.00	
 Executive Desk 700_-36	71	35.5	29	314	24.0	\$ 1184.00	<ul style="list-style-type: none"> • Locking box/box/file pedestal • Locking file/file pedestal • Pedestals ship set-up • Requires assembly
Consists of:							
-821 Desk Shell	71	35.5	29	162	6.8	\$ 450.00	
-831 B/B/F Pedestal	15.5	22	28	78	8.6	\$ 380.00	
-832 F/F Pedestal	15.5	22	28	74	8.6	\$ 354.00	
 Executive Desk 700_-31	66	30	29	286	21.7	\$ 1139.00	
Consists of:							
-921 Desk Shell	66	30	29	134	4.5	\$ 405.00	
-831 B/B/F Pedestal	15.5	22	28	78	8.6	\$ 380.00	
-832 F/F Pedestal	15.5	22	28	74	8.6	\$ 354.00	
 Junior Executive Desk 700_-30	60	30	29	278	21.3	\$ 1120.00	
Consists of:							
-121 Desk Shell	60	30	29	126	4.1	\$ 386.00	
-831 B/B/F Pedestal	15.5	22	28	78	8.6	\$ 380.00	
-832 F/F Pedestal	15.5	22	28	74	8.6	\$ 354.00	
 Executive Desk with 3/4 Pedestals 700_-36Q	71	35.5	29	284	20.0	\$ 1056.00	<ul style="list-style-type: none"> • Two locking box/file pedestals • Pedestals ship set-up • Requires assembly
Consists of:							
-821 Desk Shell	71	35.5	29	162	6.8	\$ 450.00	
-838 B/F 3/4 Pedestal	15.5	22.25	20.75	61	6.6	\$ 303.00	
-838 B/F 3/4 Pedestal	15.5	22.25	20.75	61	6.6	\$ 303.00	
 Executive Desk with 3/4 Pedestals 700_-31Q	66	30	29	256	17.7	\$ 1011.00	
Consists of:							
-921 Desk Shell	66	30	29	134	4.5	\$ 405.00	
-838 B/F 3/4 Pedestal	15.5	22.25	20.75	61	6.6	\$ 303.00	
-838 B/F 3/4 Pedestal	15.5	22.25	20.75	61	6.6	\$ 303.00	
 Junior Executive Desk with 3/4 Pedestals 700_-30Q	60	30	29	250	18.2	\$ 992.00	
Consists of:							
-121 Desk Shell	60	30	29	128	5.0	\$ 386.00	
-838 B/F 3/4 Pedestal	15.5	22.25	20.75	61	6.6	\$ 303.00	
-838 B/F 3/4 Pedestal	15.5	22.25	20.75	61	6.6	\$ 303.00	
 Three-Drawer Sales Desk 700_-3233	71	35.5	29	195	15.5	\$ 842.00	<ul style="list-style-type: none"> • Locking box/box/file pedestal • Pedestal ships set-up • Requires assembly
Consists of:							
-620 Executive Bullet Desk Shell	71	35.5	29	108	5.8	\$ 372.00	
-630 Bullet Support Ped	2.5	2.5	28	9	1.1	\$ 90.00	
-831 B/B/F Pedestal	15.5	22	28	78	8.6	\$ 380.00	

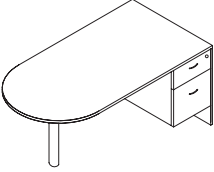
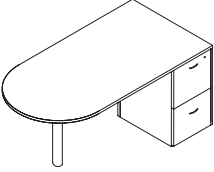
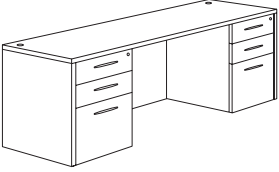

DMI COLLECTION

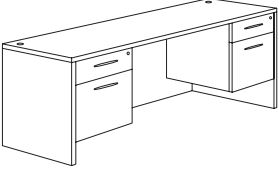
7003 Grey / 7004 Mocha / 7005 Cognac Cherry / 7006 Mahogany / 7007 Walnut Finishes

	Item Description	W"	D"	H"	Weight	Cubic	List	Features
	Model Number				Lbs.	Ft.	Price	
	Sales Desk with 3/4 Pedestal							
	700_-3233Q	71	35.5	29	178	13.5	\$ 765.00	<ul style="list-style-type: none"> • Locking box/file pedestal • Pedestal ships set-up • Requires assembly
	Consists of:							
	-620 Executive Bullet Desk Shell	71	35.5	29	108	5.8	\$ 372.00	
	-630 Bullet Support Ped	2.5	2.5	28	9	1.1	\$ 90.00	
-838 B/F 3/4 Pedestal	15.5	22.25	20.75	61	6.6	\$ 303.00		
	Two-Drawer Sales Desk							
	700_-3435	71	35.5	29	191	15.5	\$ 816.00	<ul style="list-style-type: none"> • Locking file/file pedestal • Pedestal ships set-up • Requires assembly
	Consists of:							
	-620 Executive Bullet Desk Shell	71	35.5	29	108	5.8	\$ 372.00	
	-630 Bullet Support Ped	2.5	2.5	28	9	1.1	\$ 90.00	
-832 F/F Pedestal	15.5	22	28	74	8.6	\$ 354.00		
	Executive Kneehole Credenza							
	700_-21	71	23.75	29	278	22.7	\$ 1114.00	<ul style="list-style-type: none"> • Two locking box/box/file pedestals • Pedestals ship set-up • Requires assembly
	Consists of:							
	-825 Credenza Shell	71	23.75	29	122	5.5	\$ 354.00	
	-831 B/B/F Pedestal	15.5	22	28	78	8.6	\$ 380.00	
-831 B/B/F Pedestal	15.5	22	28	78	8.6	\$ 380.00		
	Kneehole Credenza							
	700_-19	66	23.75	29	272	22.1	\$ 1105.00	
	Consists of:							
	-925 Credenza Shell	71	23.75	29	116	4.9	\$ 345.00	
	-831 B/B/F Pedestal	15.5	22	28	78	8.6	\$ 380.00	
-831 B/B/F Pedestal	15.5	22	28	78	8.6	\$ 380.00		
	Kneehole Credenza							
	700_-18	60	23.75	29	272	21.0	\$ 1063.00	
	Consists of:							
	-926 Credenza Shell	60	23.75	29	116	3.8	\$ 303.00	
	-831 B/B/F Pedestal	15.5	22	28	78	8.6	\$ 380.00	
-831 B/B/F Pedestal	15.5	22	28	78	8.6	\$ 380.00		
	Executive Kneehole Credenza with 3/4 Pedestals							
	700_-21Q	71	23.75	29	244	18.7	\$ 960.00	<ul style="list-style-type: none"> • Two locking box/file pedestals • Pedestals ship set-up • Requires assembly
	Consists of:							
	-825 Credenza Shell	71	23.75	29	122	5.5	\$ 354.00	
	-838 B/F 3/4 Pedestal	15.5	22.25	20.75	61	6.6	\$ 303.00	
-838 B/F 3/4 Pedestal	15.5	22.25	20.75	61	6.6	\$ 303.00		
	Kneehole Credenza with 3/4 Pedestals							
	700_-19Q	66	23.75	29	238	18.1	\$ 951.00	
	Consists of:							
	-925 Credenza Shell	71	23.75	29	116	4.9	\$ 345.00	
	-838 B/F 3/4 Pedestal	15.5	22.25	20.75	61	6.6	\$ 303.00	
-838 B/F 3/4 Pedestal	15.5	22.25	20.75	61	6.6	\$ 303.00		
	Kneehole Credenza with 3/4 Pedestals							
	700_-18Q	60	23.75	29	238	17.0	\$ 909.00	
	Consists of:							
	-926 Credenza Shell	60	23.75	29	116	3.8	\$ 303.00	
	-838 B/F 3/4 Pedestal	15.5	22.25	20.75	61	6.6	\$ 303.00	
-838 B/F 3/4 Pedestal	15.5	22.25	20.75	61	6.6	\$ 303.00		

Fairplex LAMINATE COLLECTION





FLEXSTEEL®
CONTRACT

7003 Grey / 7004 Mocha / 7005 Cognac Cherry / 7006 Mahogany / 7007 Walnut Finishes

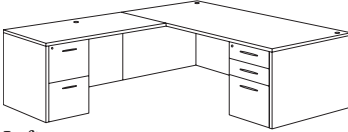
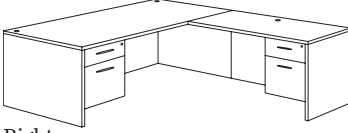
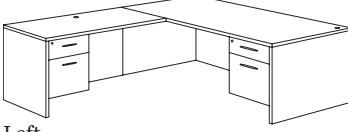
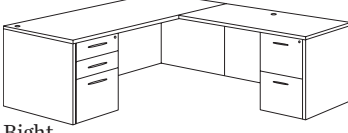
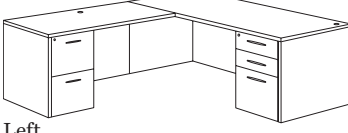
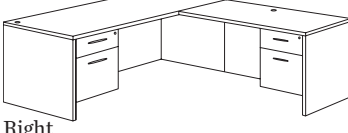
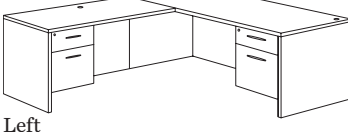
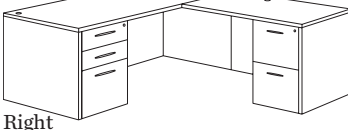
DMI COLLECTION

	Item Description	W"	D"	H"	Weight	Cubic	List	
	Model Number				Lbs.	Ft.	Price	Features
 Right	Right/Left Executive L Desk 700_-4748E	71	82.75	29	404	28.1	\$ 1487.00	<ul style="list-style-type: none"> • Locking box/box/file pedestal • Locking file/file pedestal • Pedestals ship set-up • Requires assembly
	Consists of:							
	-821 Desk Shell	71	35.5	29	162	6.8	\$ 450.00	
	-831 B/B/F Pedestal	15.5	22	28	78	8.6	\$ 380.00	
	-824 Return Shell	47.25	23.75	29	90	4.1	\$ 303.00	
	-832 F/F Pedestal	15.5	22	28	74	8.6	\$ 354.00	
 Left	Right/Left Executive L Desk 700_-4748	71	77.5	29	391	27.0	\$ 1480.00	
	Consists of:							
	-821 Desk Shell	71	35.5	29	162	6.8	\$ 450.00	
	-831 B/B/F Pedestal	15.5	22	28	78	8.6	\$ 380.00	
	-924 Return Shell	42	23.75	29	77	3.0	\$ 296.00	
	-832 F/F Pedestal	15.5	22	28	74	8.6	\$ 354.00	
 Right	Right/Left Executive L Desk with 3/4 Pedestals 700_-4748EQ	71	82.75	29	374	24.1	\$ 1359.00	<ul style="list-style-type: none"> • Two locking box/file pedestals • Pedestals ship set-up • Requires assembly
	Consists of:							
	-821 Desk Shell	71	35.5	29	162	6.8	\$ 450.00	
	-838 B/F 3/4 Pedestal	15.5	22.25	20.75	61	6.6	\$ 303.00	
	-824 Return Shell	47.25	23.75	29	90	4.1	\$ 303.00	
	-838 B/F 3/4 Pedestal	15.5	22.25	20.75	61	6.6	\$ 303.00	
 Left	Right/Left Executive L Desk with 3/4 Pedestals 700_-4748Q	71	77.5	29	361	23.0	\$ 1352.00	
	Consists of:							
	-821 Desk Shell	71	35.5	29	162	6.8	\$ 450.00	
	-838 B/F 3/4 Pedestal	15.5	22.25	20.75	61	6.6	\$ 303.00	
	-924 Return Shell	42	23.75	29	77	3.0	\$ 296.00	
	-838 B/F 3/4 Pedestal	15.5	22.25	20.75	61	6.6	\$ 303.00	
 Right	Right/Left Junior Executive L Desk 700_-2728E	66	77.25	29	376	24.0	\$ 1442.00	<ul style="list-style-type: none"> • Locking box/box/file pedestal • Locking file/file pedestal • Pedestals ship set-up • Requires assembly
	Consists of:							
	-921 Desk Shell	66	30	29	134	4.5	\$ 405.00	
	-831 B/B/F Pedestal	15.5	22	28	78	8.6	\$ 380.00	
	-824 Return Shell	47.25	23.75	29	90	4.1	\$ 303.00	
	-832 F/F Pedestal	15.5	22	28	74	8.6	\$ 354.00	
 Left	Right/Left Junior Executive L Desk 700_-2728	66	72	29	363	24.7	\$ 1435.00	
	Consists of:							
	-921 Desk Shell	66	30	29	134	4.5	\$ 405.00	
	-831 B/B/F Pedestal	15.5	22	28	78	8.6	\$ 380.00	
	-924 Return Shell	42	23.75	29	77	3.0	\$ 296.00	
	-832 F/F Pedestal	15.5	22	28	74	8.6	\$ 354.00	
 Right	Right/Left Junior Executive L Desk with 3/4 Pedestals 700_-2728EQ	66	77.25	29	346	21.8	\$ 1314.00	<ul style="list-style-type: none"> • Two locking box/file pedestals • Pedestals ship set-up • Requires assembly
	Consists of:							
	-921 Desk Shell	66	30	29	134	4.5	\$ 405.00	
	-838 B/F 3/4 Pedestal	15.5	22.25	20.75	61	6.6	\$ 303.00	
	-824 Return Shell	47.25	23.75	29	90	4.1	\$ 303.00	
	-838 B/F 3/4 Pedestal	15.5	22.25	20.75	61	6.6	\$ 303.00	
 Left	Right/Left Junior Executive L Desk with 3/4 Pedestals 700_-2728Q	66	72	29	333	20.7	\$ 1307.00	
	Consists of:							
	-921 Desk Shell	66	30	29	134	4.5	\$ 405.00	
	-838 B/F 3/4 Pedestal	15.5	22.25	20.75	61	6.6	\$ 303.00	
	-924 Return Shell	42	23.75	29	77	3.0	\$ 296.00	
	-838 B/F 3/4 Pedestal	15.5	22.25	20.75	61	6.6	\$ 303.00	
 Right	Right/Left L Desk 700_-1718	60	72	29	355	24.3	\$ 1416.00	<ul style="list-style-type: none"> • Locking box/box/file pedestal • Locking file/file pedestal • Pedestals ship set-up • Requires assembly
	Consists of:							
	-121 Desk Shell	60	30	29	126	4.1	\$ 386.00	
	-831 B/B/F Pedestal	15.5	22	28	78	8.6	\$ 380.00	
	-924 Return Shell	42	23.75	29	77	3.0	\$ 296.00	
	-832 F/F Pedestal	15.5	22	28	74	8.6	\$ 354.00	

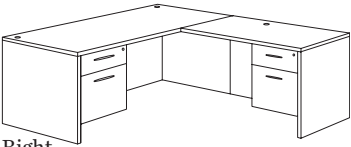

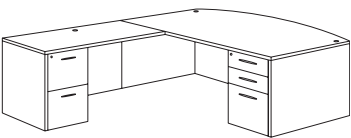
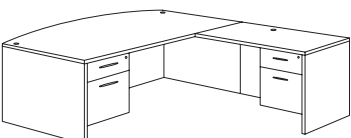
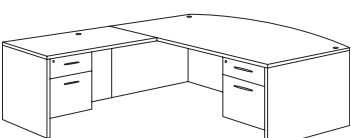
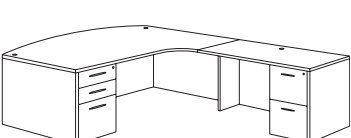
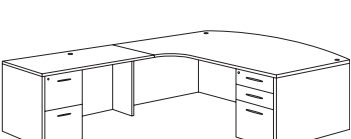
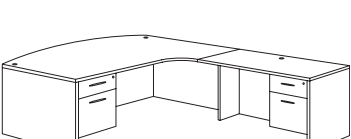
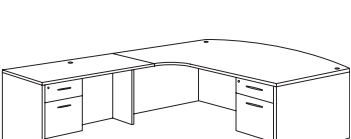
	Item Description	W"	D"	H"	Weight	Cubic	List	Features
	Model Number				Lbs.	Ft.	Price	
	Right/Left L Desk with 3/4 Pedestals	60	72	29	325	20.3	\$ 1288.00	<ul style="list-style-type: none"> • Two locking box/file pedestals • Pedestals ship set-up • Requires assembly
	700_-1718Q							
	Consists of:							
	-121 Desk Shell	60	30	29	126	4.1	\$ 386.00	
	-838 B/F 3/4 Pedestal	15.5	22.25	20.75	61	6.6	\$ 303.00	
	Right/Left Executive Bow Front L Desk	71	88.5	29	415	29.1	\$ 1552.00	<ul style="list-style-type: none"> • Locking box/box/file pedestal • Locking file/file pedestal • Pedestals ship set-up • Requires assembly
	700_-4748EB							
	Consists of:							
	-822 Desk Shell w/Bow Top	71	41.25	29	173	7.8	\$ 515.00	
	-831 B/B/F Pedestal	15.5	22	28	78	8.6	\$ 380.00	
	Right/Left Bow Front L Desk	71	83.25	29	402	28.0	\$ 1545.00	
	700_-4748B							
	Consists of:							
	-822 Desk Shell w/Bow Top	71	41.25	29	173	7.8	\$ 515.00	
	-831 B/B/F Pedestal	15.5	22	28	78	8.6	\$ 380.00	
	Right/Left Executive Bow Front L Desk with 3/4 Pedestals	71	88.5	29	385	25.1	\$ 1424.00	<ul style="list-style-type: none"> • Two locking box/file pedestals • Pedestals ship set-up • Requires assembly
	700_-4748EBQ							
	Consists of:							
	-822 Desk Shell w/Bow Top	71	41.25	29	173	7.8	\$ 515.00	
	-838 B/F 3/4 Pedestal	15.5	22.25	20.75	61	6.6	\$ 303.00	
	Right/Left Bow Front L Desk with 3/4 Pedestals	71	83.25	29	372	24.0	\$ 1417.00	
	700_-4748BQ							
	Consists of:							
	-822 Desk Shell w/Bow Top	71	41.25	29	173	7.8	\$ 515.00	
	-838 B/F 3/4 Pedestal	15.5	22.25	20.75	61	6.6	\$ 303.00	
	Right Executive Corner Bow Front L Desk	71	95.25	29	426	30.3	\$ 1623.00	<ul style="list-style-type: none"> • Locking box/box/file pedestal • Locking file/file pedestal • Pedestals ship set-up • Requires assembly
	700_-47ECB							
	Consists of:							
	-322 RT Corner Desk Shell w/Bow	71	48	29	184	9.0	\$ 586.00	
	-831 B/B/F Pedestal	15.5	22	28	78	8.6	\$ 380.00	
	Left Executive Corner Bow Front L Desk	71	95.25	29	426	30.3	\$ 1623.00	
	700_-48ECB							
	Consists of:							
	-321 LT Corner Desk Shell w/Bow	71	48	29	184	9.0	\$ 586.00	
	-831 B/B/F Pedestal	15.5	22	28	78	8.6	\$ 380.00	
	Right Executive Corner Bow Front L Desk with 3/4 Pedestals	71	95.25	29	396	26.3	\$ 1495.00	<ul style="list-style-type: none"> • Two locking box/file pedestals • Pedestals ship set-up • Requires assembly
	700_-47ECBQ							
	Consists of:							
	-322 RT Corner Desk Shell w/Bow	71	48	29	184	9.0	\$ 586.00	
	-838 B/F 3/4 Pedestal	15.5	22.25	20.75	61	6.6	\$ 303.00	
	Left Executive Corner Bow Front L Desk with 3/4 Pedestals	71	95.25	29	396	26.3	\$ 1495.00	
	700_-48ECBQ							
	Consists of:							
	-321 LT Corner Desk Shell w/Bow	71	48	29	184	9.0	\$ 586.00	
	-838 B/F 3/4 Pedestal	15.5	22.25	20.75	61	6.6	\$ 303.00	

Fairplex LAMINATE COLLECTION



FLEXSTEEL®
CONTRACT

7003 Grey / 7004 Mocha / 7005 Cognac Cherry / 7006 Mahogany / 7007 Walnut Finishes

DMI COLLECTION

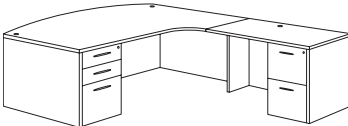
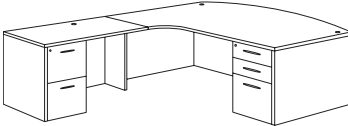
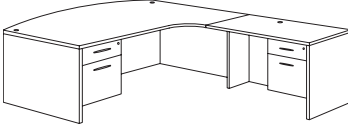
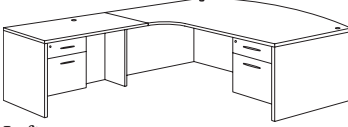
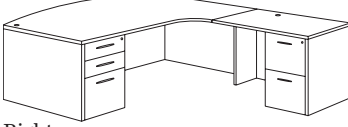
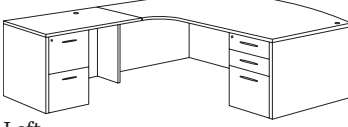
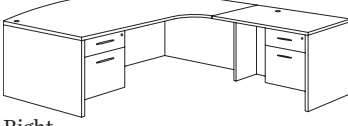
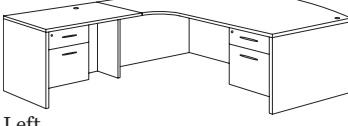
	Item Description	W"	D"	H"	Weight	Cubic	List	
	Model Number				Lbs.	Ft.	Price	Features
 Right	Right Corner Bow Front L Desk							
	700_-47CB	71	90	29	413	29.2	\$ 1616.00	<ul style="list-style-type: none"> • Locking box/box/file pedestal • Locking file/file pedestal • Pedestals ship set-up • Requires assembly
	Consists of:							
	-322 RT Corner Desk Shell w/Bow	71	48	29	184	9.0	\$ 586.00	
	-831 B/B/F Pedestal	15.5	22	28	78	8.6	\$ 380.00	
 Left	Left Corner Bow Front L Desk							
	700_-48CB	71	90	29	413	29.2	\$ 1616.00	
	Consists of:							
	-321 LT Corner Desk Shell w/Bow	71	48	29	184	9.0	\$ 586.00	
	-831 B/B/F Pedestal	15.5	22	28	78	8.6	\$ 380.00	
 Right	Right Corner Bow Front L Desk with 3/4 Pedestals							
	700_-47CBQ	71	90	29	383	25.2	\$ 1488.00	<ul style="list-style-type: none"> • Two locking box/file pedestals • Pedestals ship set-up • Requires assembly
	Consists of:							
	-322 RT Corner Desk Shell w/Bow	71	48	29	184	9.0	\$ 586.00	
	-838 B/F 3/4 Pedestal	15.5	22.25	20.75	61	6.6	\$ 303.00	
 Left	Left Corner Bow Front L Desk with 3/4 Pedestals							
	700_-48CBQ	71	90	29	383	25.2	\$ 1488.00	
	Consists of:							
	-321 LT Corner Desk Shell w/Bow	71	48	29	184	9.0	\$ 586.00	
	-838 B/F 3/4 Pedestal	15.5	22.25	20.75	61	6.6	\$ 303.00	
 Right	Right Junior Executive Corner Bow Front L Desk							
	700_-47CBJ	71	83.5	29	410	29.3	\$ 1559.00	<ul style="list-style-type: none"> • Locking box/box/file pedestal • Locking file/file pedestal • Pedestals ship set-up • Requires assembly
	Consists of:							
	-322 RT Corner Desk Shell w/Bow	71	48	29	184	9.0	\$ 586.00	
	-831 B/B/F Pedestal	15.5	22	28	78	8.6	\$ 380.00	
 Left	Left Junior Executive Corner Bow Front L Desk							
	700_-48CBJ	71	83.5	29	410	29.3	\$ 1559.00	
	Consists of:							
	-321 LT Corner Desk Shell w/Bow	71	48	29	184	9.0	\$ 586.00	
	-831 B/B/F Pedestal	15.5	22	28	78	8.6	\$ 380.00	
 Right	Right Junior Executive Corner Bow Front L Desk with 3/4 Pedestals							
	700_-47CBJQ	71	83.5	29	380	25.3	\$ 1431.00	<ul style="list-style-type: none"> • Two locking box/file pedestals • Pedestals ship set-up • Requires assembly
	Consists of:							
	-322 RT Corner Desk Shell w/Bow	71	48	29	184	9.0	\$ 586.00	
	-838 B/F 3/4 Pedestal	15.5	22.25	20.75	61	6.6	\$ 303.00	
 Left	Left Junior Executive Corner Bow Front L Desk with 3/4 Pedestals							
	700_-48CBJQ	71	83.5	29	380	25.3	\$ 1431.00	
	Consists of:							
	-321 LT Corner Desk Shell w/Bow	71	48	29	184	9.0	\$ 586.00	
	-838 B/F 3/4 Pedestal	15.5	22.25	20.75	61	6.6	\$ 303.00	



DMI COLLECTION

7003 Grey / 7004 Mocha / 7005 Cognac Cherry / 7006 Mahogany / 7007 Walnut Finishes

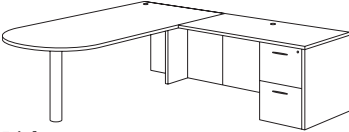
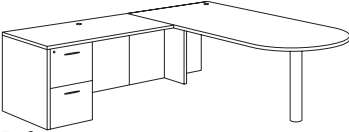
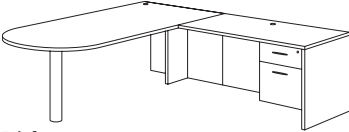
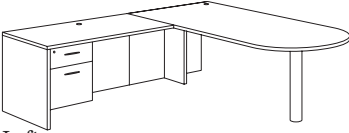
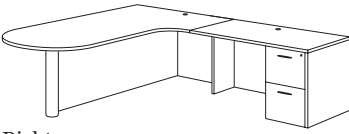
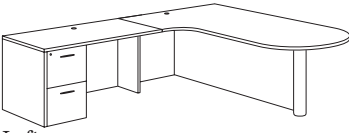
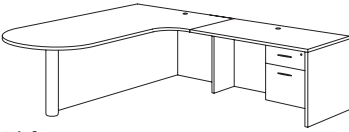
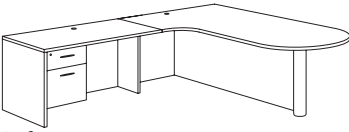
	Item Description	W"	D"	H"	Weight	Cubic	List	Features
	Model Number				Lbs.	Ft.	Price	
	Right/Left Executive Bullet L Desk	71	82.75	29	281	19.6	\$ 1119.00	<ul style="list-style-type: none"> • Locking file/file pedestal • Pedestal ships set-up • Requires assembly
	700_-4546E							
	Consists of:							
	-620 Executive Bullet Desk Shell	71	35.5	29	108	5.8	\$ 372.00	
	-630 Bullet Support Ped	2.5	2.5	28	9	1.1	\$ 90.00	
	Right/Left Bullet L Desk	71	77.5	29	268	18.5	\$ 1112.00	
	700_-4546							
	Consists of:							
	-620 Executive Bullet Desk Shell	71	35.5	29	108	5.8	\$ 372.00	
	-630 Bullet Support Ped	2.5	2.5	28	9	1.1	\$ 90.00	
	Right/Left Executive Bullet L Desk with 3/4 Pedestals	71	82.75	29	268	17.6	\$ 1068.00	<ul style="list-style-type: none"> • Locking box/file pedestal • Pedestal ships set-up • Requires assembly
	700_-4546EQ							
	Consists of:							
	-620 Executive Bullet Desk Shell	71	35.5	29	108	5.8	\$ 372.00	
	-630 Bullet Support Ped	2.5	2.5	28	9	1.1	\$ 90.00	
	Right/Left Bullet L Desk with 3/4 Pedestals	71	77.5	29	255	16.5	\$ 1061.00	
	700_-4546Q							
	Consists of:							
	-620 Executive Bullet Desk Shell	71	35.5	29	108	5.8	\$ 372.00	
	-630 Bullet Support Ped	2.5	2.5	28	9	1.1	\$ 90.00	
	Right Executive Corner Peninsula/Bullet L Desk	71	89.25	29	309	21.4	\$ 1326.00	<ul style="list-style-type: none"> • Locking file/file pedestal • Pedestal ships set-up • Requires assembly
	700_-45ECP							
	Consists of:							
	-222 Right Corner Pen/Bullet Shell	71	42	29	139	8.0	\$ 521.00	
	-230 Corner Pen/Bullet Base	2.5	2.5	28	6	0.7	\$ 148.00	
	Left Executive Corner Peninsula/Bullet L Desk	71	89.25	29	309	21.4	\$ 1326.00	
	700_-46ECP							
	Consists of:							
	-221 Left Corner Pen/Bullet Shell	71	42	29	139	8.0	\$ 521.00	
	-230 Corner Pen/Bullet Base	2.5	2.5	28	6	0.7	\$ 148.00	
	Right Executive Corner Peninsula/Bullet L Desk with 3/4 Pedestals	71	89.25	29	296	19.4	\$ 1275.00	<ul style="list-style-type: none"> • Locking box/file pedestal • Pedestal ships set-up • Requires assembly
	700_-45ECPQ							
	Consists of:							
	-222 Right Corner Pen/Bullet Shell	71	42	29	139	8.0	\$ 521.00	
	-230 Corner Pen/Bullet Base	2.5	2.5	28	6	0.7	\$ 148.00	
	Left Executive Corner Peninsula/Bullet L Desk with 3/4 Pedestals	71	89.25	29	296	19.4	\$ 1275.00	
	700_-46ECPQ							
	Consists of:							
	-221 Left Corner Pen/Bullet Shell	71	42	29	139	8.0	\$ 521.00	
	-230 Corner Pen/Bullet Base	2.5	2.5	28	6	0.7	\$ 148.00	

Fairplex LAMINATE COLLECTION



FLEXSTEEL®
CONTRACT

7003 Grey / 7004 Mocha / 7005 Cognac Cherry / 7006 Mahogany / 7007 Walnut Finishes

DMI COLLECTION

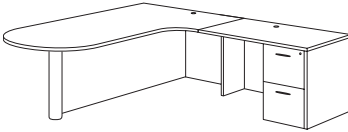
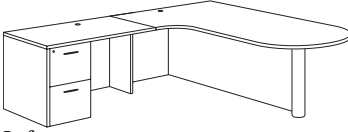
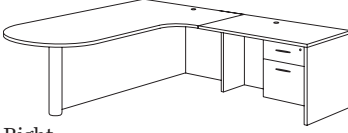
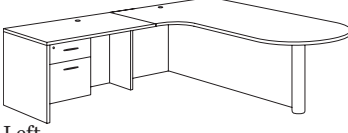
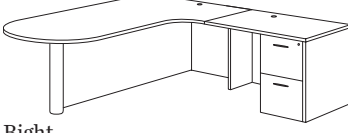
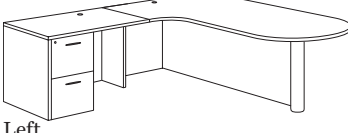
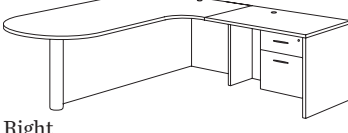
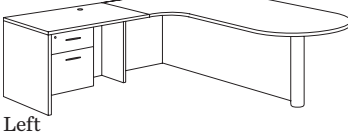
	Item Description	W"	D"	H"	Weight Lbs.	Cubic Ft.	List Price	Features
 Right	Right Corner Peninsula/Bullet L Desk 700_-45CP	71	84	29	296	20.3	\$ 1319.00	<ul style="list-style-type: none"> • Locking file/file pedestal • Pedestal ships set-up • Requires assembly
	Consists of:							
	-222 Right Corner Pen/Bullet Shell	71	42	29	139	8.0	\$ 521.00	
	-230 Corner Pen/Bullet Base	2.5	2.5	28	6	0.7	\$ 148.00	
	-924 Return Shell	42	23.75	29	77	3.0	\$ 296.00	
-832 F/F Pedestal	15.5	22	28	74	8.6	\$ 354.00		
 Left	Left Corner Peninsula/Bullet L Desk 700_-46CP	71	84	29	296	20.3	\$ 1319.00	
	Consists of:							
	-221 Left Corner Pen/Bullet Shell	71	42	29	139	8.0	\$ 521.00	
	-230 Corner Pen/Bullet Base	2.5	2.5	28	6	0.7	\$ 148.00	
	-924 Return Shell	42	23.75	29	77	3.0	\$ 296.00	
-832 F/F Pedestal	15.5	22	28	74	8.6	\$ 354.00		
 Right	Right Corner Peninsula/Bullet L Desk with 3/4 Pedestals 700_-45CPQ	71	84	29	283	18.3	\$ 1268.00	<ul style="list-style-type: none"> • Locking box/file pedestal • Pedestal ships set-up • Requires assembly
	Consists of:							
	-222 Right Corner Pen/Bullet Shell	71	42	29	139	8.0	\$ 521.00	
	-230 Corner Pen/Bullet Base	2.5	2.5	28	6	0.7	\$ 148.00	
	-924 Return Shell	42	23.75	29	77	3.0	\$ 296.00	
-838 B/F 3/4 Pedestal	15.5	22.25	20.75	61	6.6	\$ 303.00		
 Left	Left Corner Peninsula/Bullet L Desk with 3/4 Pedestals 700_-46CPQ	71	84	29	283	18.3	\$ 1268.00	
	Consists of:							
	-221 Left Corner Pen/Bullet Shell	71	42	29	139	8.0	\$ 521.00	
	-230 Corner Pen/Bullet Base	2.5	2.5	28	6	0.7	\$ 148.00	
	-924 Return Shell	42	23.75	29	77	3.0	\$ 296.00	
-838 B/F 3/4 Pedestal	15.5	22.25	20.75	61	6.6	\$ 303.00		
 Right	Right Junior Executive Corner Peninsula/Bullet L Desk 700_-45CPJ	71	77.5	29	293	20.4	\$ 1262.00	<ul style="list-style-type: none"> • Locking file/file pedestal • Pedestal ships set-up • Requires assembly
	Consists of:							
	-222 Right Corner Pen/Bullet Shell	71	42	29	139	8.0	\$ 521.00	
	-230 Corner Pen/Bullet Base	2.5	2.5	28	6	0.7	\$ 148.00	
	-324 Return Shell	35.5	23.75	29	74	3.1	\$ 239.00	
-832 F/F Pedestal	15.5	22	28	74	8.6	\$ 354.00		
 Left	Left Junior Executive Corner Peninsula/Bullet L Desk 700_-46CPJ	71	77.5	29	293	20.4	\$ 1262.00	
	Consists of:							
	-221 Left Corner Pen/Bullet Shell	71	42	29	139	8.0	\$ 521.00	
	-230 Corner Pen/Bullet Base	2.5	2.5	28	6	0.7	\$ 148.00	
	-324 Return Shell	35.5	23.75	29	74	3.1	\$ 239.00	
-832 F/F Pedestal	15.5	22	28	74	8.6	\$ 354.00		
 Right	Right Junior Executive Corner Peninsula/Bullet L Desk with 3/4 Pedestals 700_-45CPJQ	71	77.5	29	280	18.4	\$ 1211.00	<ul style="list-style-type: none"> • Locking box/file pedestal • Pedestal ships set-up • Requires assembly
	Consists of:							
	-222 Right Corner Pen/Bullet Shell	71	42	29	139	8.0	\$ 521.00	
	-230 Corner Pen/Bullet Base	2.5	2.5	28	6	0.7	\$ 148.00	
	-324 Return Shell	35.5	23.75	29	74	3.1	\$ 239.00	
-838 B/F 3/4 Pedestal	15.5	22.25	20.75	61	6.6	\$ 303.00		
 Left	Left Junior Executive Corner Peninsula/Bullet L Desk with 3/4 Pedestals 700_-46CPJQ	71	77.5	29	280	18.4	\$ 1211.00	
	Consists of:							
	-221 Left Corner Pen/Bullet Shell	71	42	29	139	8.0	\$ 521.00	
	-230 Corner Pen/Bullet Base	2.5	2.5	28	6	0.7	\$ 148.00	
	-324 Return Shell	35.5	23.75	29	74	3.1	\$ 239.00	
-838 B/F 3/4 Pedestal	15.5	22.25	20.75	61	6.6	\$ 303.00		

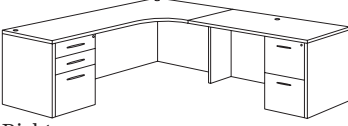
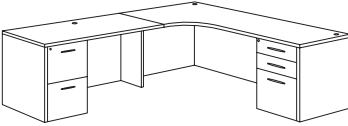
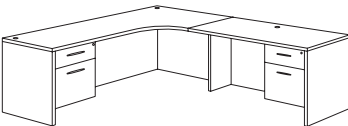
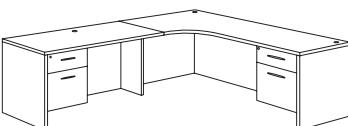
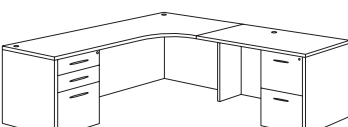
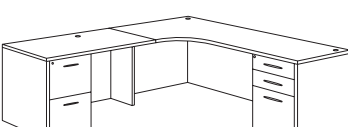
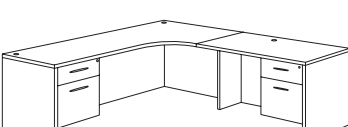
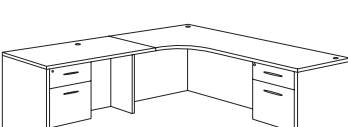

	Item Description	W"	D"	H"	Weight Lbs.	Cubic Ft.	List Price	Features
 Right	Right Executive Corner L Desk 700_-50E	71	82.75	29	391	28.1	\$ 1533.00	<ul style="list-style-type: none"> • Locking box/box/file pedestal • Locking file/file pedestal • Pedestals ship set-up • Requires assembly
	Consists of:							
	-622 Right Corner Credenza Shell	71	35.5	29	149	6.8	\$ 496.00	
	-831 B/B/F Pedestal	15.5	22	28	78	8.6	\$ 380.00	
	-824 Return Shell	47.25	23.75	29	90	4.1	\$ 303.00	
	-832 F/F Pedestal	15.5	22	28	74	8.6	\$ 354.00	
 Left	Left Executive Corner L Desk 700_-51E	71	82.75	29	391	28.1	\$ 1533.00	
	Consists of:							
	-621 Left Corner Credenza Shell	71	35.5	29	149	6.8	\$ 496.00	
	-831 B/B/F Pedestal	15.5	22	28	78	8.6	\$ 380.00	
	-824 Return Shell	47.25	23.75	29	90	4.1	\$ 303.00	
	-832 F/F Pedestal	15.5	22	28	74	8.6	\$ 354.00	
 Right	Right Executive Corner L Desk with 3/4 Pedestals 700_-50EQ	71	82.75	29	361	24.1	\$ 1405.00	<ul style="list-style-type: none"> • Two locking box/file pedestals • Pedestals ship set-up • Requires assembly
	Consists of:							
	-622 Right Corner Credenza Shell	71	35.5	29	149	6.8	\$ 496.00	
	-838 B/F 3/4 Pedestal	15.5	22.25	20.75	61	6.6	\$ 303.00	
	-824 Return Shell	47.25	23.75	29	90	4.1	\$ 303.00	
	-838 B/F 3/4 Pedestal	15.5	22.25	20.75	61	6.6	\$ 303.00	
 Left	Left Executive Corner L Desk with 3/4 Pedestals 700_-51EQ	71	82.75	29	361	24.1	\$ 1405.00	
	Consists of:							
	-621 Left Corner Credenza Shell	71	35.5	29	149	6.8	\$ 496.00	
	-838 B/F 3/4 Pedestal	15.5	22.25	20.75	61	6.6	\$ 303.00	
	-824 Return Shell	47.25	23.75	29	90	4.1	\$ 303.00	
	-838 B/F 3/4 Pedestal	15.5	22.25	20.75	61	6.6	\$ 303.00	
 Right	Right Corner L Desk 700_-50	71	77.5	29	378	27.0	\$ 1526.00	<ul style="list-style-type: none"> • Locking box/box/file pedestal • Locking file/file pedestal • Pedestals ship set-up • Requires assembly
	Consists of:							
	-622 Right Corner Credenza Shell	71	35.5	29	149	6.8	\$ 496.00	
	-831 B/B/F Pedestal	15.5	22	28	78	8.6	\$ 380.00	
	-924 Return Shell	42	23.75	29	77	3.0	\$ 296.00	
	-832 F/F Pedestal	15.5	22	28	74	8.6	\$ 354.00	
 Left	Left Corner L Desk 700_-51	71	77.5	29	378	27.0	\$ 1526.00	
	Consists of:							
	-621 Left Corner Credenza Shell	71	35.5	29	149	6.8	\$ 496.00	
	-831 B/B/F Pedestal	15.5	22	28	78	8.6	\$ 380.00	
	-924 Return Shell	42	23.75	29	77	3.0	\$ 296.00	
	-832 F/F Pedestal	15.5	22	28	74	8.6	\$ 354.00	
 Right	Right Corner L Desk with 3/4 Pedestals 700_-50Q	71	77.5	29	348	23.0	\$ 1398.00	<ul style="list-style-type: none"> • Two locking box/file pedestals • Pedestals ship set-up • Requires assembly
	Consists of:							
	-622 Right Corner Credenza Shell	71	35.5	29	149	6.8	\$ 496.00	
	-838 B/F 3/4 Pedestal	15.5	22.25	20.75	61	6.6	\$ 303.00	
	-924 Return Shell	42	23.75	29	77	3.0	\$ 296.00	
	-838 B/F 3/4 Pedestal	15.5	22.25	20.75	61	6.6	\$ 303.00	
 Left	Left Corner L Desk with 3/4 Pedestals 700_-51Q	71	77.5	29	348	23.0	\$ 1398.00	
	Consists of:							
	-621 Left Corner Credenza Shell	71	35.5	29	149	6.8	\$ 496.00	
	-838 B/F 3/4 Pedestal	15.5	22.25	20.75	61	6.6	\$ 303.00	
	-924 Return Shell	42	23.75	29	77	3.0	\$ 296.00	
	-838 B/F 3/4 Pedestal	15.5	22.25	20.75	61	6.6	\$ 303.00	



Fairplex LAMINATE COLLECTION



FLEXSTEEL®
CONTRACT

7003 Grey / 7004 Mocha / 7005 Cognac Cherry / 7006 Mahogany / 7007 Walnut Finishes

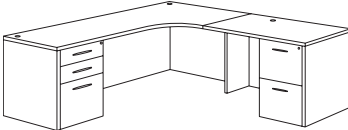
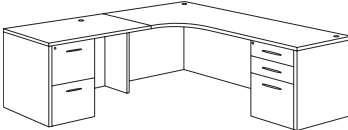
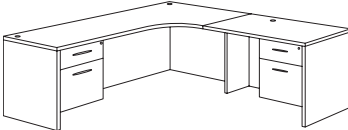
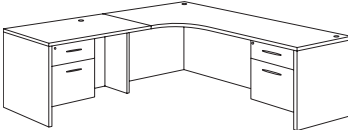
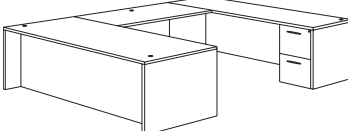
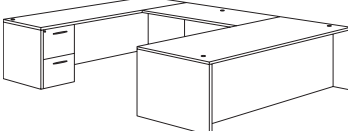
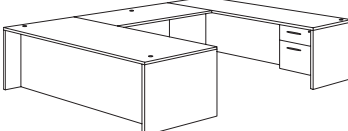
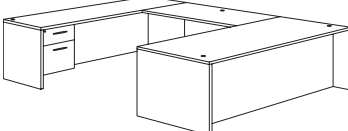
DMI COLLECTION

	Item Description	W"	D"	H"	Weight Lbs.	Cubic Ft.	List Price	Features
	Model Number							
 Right	Right Junior Executive Corner L Desk 700_-50J	71	71	29	375	27.1	\$ 1469.00	<ul style="list-style-type: none"> • Locking box/box/file pedestal • Locking file/file pedestal • Pedestals ship set-up • Requires assembly
	Consists of:							
	-622 Right Corner Credenza Shell	71	35.5	29	149	6.8	\$ 496.00	
	-831 B/B/F Pedestal	15.5	22	28	78	8.6	\$ 380.00	
	-324 Return Shell	35.5	23.75	29	74	3.1	\$ 239.00	
	-832 F/F Pedestal	15.5	22	28	74	8.6	\$ 354.00	
 Left	Left Junior Executive Corner L Desk 700_-51J	71	71	29	375	27.1	\$ 1469.00	
	Consists of:							
	-621 Left Corner Credenza Shell	71	35.5	29	149	6.8	\$ 496.00	
	-831 B/B/F Pedestal	15.5	22	28	78	8.6	\$ 380.00	
	-324 Return Shell	35.5	23.75	29	74	3.1	\$ 239.00	
	-832 F/F Pedestal	15.5	22	28	74	8.6	\$ 354.00	
 Right	Right Junior Executive Corner L Desk with 3/4 Pedestals 700_-50JQ	71	71	29	345	23.1	\$ 1341.00	<ul style="list-style-type: none"> • Two locking box/file pedestals • Pedestals ship set-up • Requires assembly
	Consists of:							
	-622 Right Corner Credenza Shell	71	35.5	29	149	6.8	\$ 496.00	
	-838 B/F 3/4 Pedestal	15.5	22.25	20.75	61	6.6	\$ 303.00	
	-324 Return Shell	35.5	23.75	29	74	3.1	\$ 239.00	
	-838 B/F 3/4 Pedestal	15.5	22.25	20.75	61	6.6	\$ 303.00	
 Left	Left Junior Executive Corner L Desk with 3/4 Pedestals 700_-51JQ	71	71	29	345	23.1	\$ 1341.00	
	Consists of:							
	-621 Left Corner Credenza Shell	71	35.5	29	149	6.8	\$ 496.00	
	-838 B/F 3/4 Pedestal	15.5	22.25	20.75	61	6.6	\$ 303.00	
	-324 Return Shell	35.5	23.75	29	74	3.1	\$ 239.00	
	-838 B/F 3/4 Pedestal	15.5	22.25	20.75	61	6.6	\$ 303.00	
 Right	Right/Left Executive U Desk 700_-5758E	71	106.5	29	506	32.6	\$ 1764.00	<ul style="list-style-type: none"> • Locking box/box/file pedestal • Locking file/file pedestal • Pedestals ship set-up • Requires assembly
	Consists of:							
	-821 Desk Shell	71	35.5	29	162	6.8	\$ 450.00	
	-831 B/B/F Pedestal	15.5	22	28	78	8.6	\$ 380.00	
	-823 Bridge	47.25	23.75	29	70	3.1	\$ 226.00	
	-825 Credenza Shell	71	23.75	29	122	5.5	\$ 354.00	
	-832 F/F Pedestal	15.5	22	28	74	8.6	\$ 354.00	
 Left	Right/Left Executive U Desk 700_-5758	71	101.25	29	501	32.0	\$ 1744.00	
	Consists of:							
	-821 Desk Shell	71	35.5	29	162	6.8	\$ 450.00	
	-831 B/B/F Pedestal	15.5	22	28	78	8.6	\$ 380.00	
	-923 Bridge	42	23.75	29	65	2.5	\$ 206.00	
	-825 Credenza Shell	71	23.75	29	122	5.5	\$ 354.00	
	-832 F/F Pedestal	15.5	22	28	74	8.6	\$ 354.00	
 Right	Right/Left Executive U Desk with 3/4 Pedestals 700_-5758EQ	71	106.5	29	476	28.6	\$ 1636.00	<ul style="list-style-type: none"> • Two locking box/file pedestals • Pedestals ship set-up • Requires assembly
	Consists of:							
	-821 Desk Shell	71	35.5	29	162	6.8	\$ 450.00	
	-838 B/F 3/4 Pedestal	15.5	22.25	20.75	61	6.6	\$ 303.00	
	-823 Bridge	47.25	23.75	29	70	3.1	\$ 226.00	
	-825 Credenza Shell	71	23.75	29	122	5.5	\$ 354.00	
	-838 B/F 3/4 Pedestal	15.5	22.25	20.75	61	6.6	\$ 303.00	
 Left	Right/Left Executive U Desk with 3/4 Pedestals 700_-5758Q	71	101.25	29	471	28.0	\$ 1616.00	
	Consists of:							
	-821 Desk Shell	71	35.5	29	162	6.8	\$ 450.00	
	-838 B/F 3/4 Pedestal	15.5	22.25	20.75	61	6.6	\$ 303.00	
	-923 Bridge	42	23.75	29	65	2.5	\$ 206.00	
	-825 Credenza Shell	71	23.75	29	122	5.5	\$ 354.00	
	-838 B/F 3/4 Pedestal	15.5	22.25	20.75	61	6.6	\$ 303.00	
 Right	Right/Left Executive Bow Front Lateral File U Desk 700_-537538EB	71	112.25	29	586	41.9	\$ 2215.00	<ul style="list-style-type: none"> • Locking box/box/file pedestal • Locking, two lateral file drawer pedestal • Pedestals ship set-up • Requires assembly
	Consists of:							
	-822 Desk Shell w/Bow Top	71	41.25	29	173	7.8	\$ 515.00	
	-831 B/B/F Pedestal	15.5	22	28	78	8.6	\$ 380.00	
	-823 Bridge	47.25	23.75	29	70	3.1	\$ 226.00	
	-825 Credenza Shell	71	23.75	29	122	5.5	\$ 354.00	
	-827 Lateral File Pedestal	35.5	22	29	143	16.9	\$ 740.00	

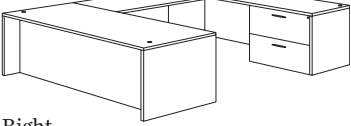
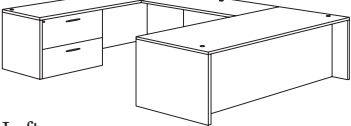
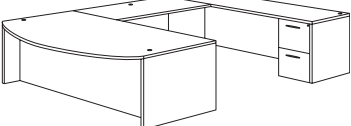
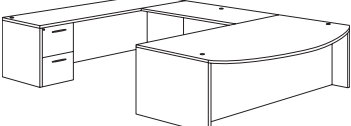
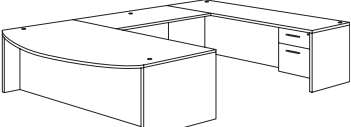
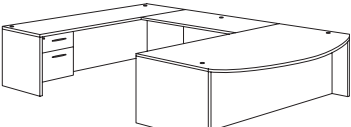
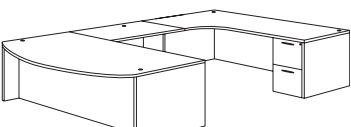
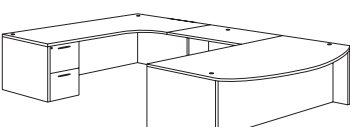

	Item Description	W"	D"	H"	Weight	Cubic	List	
	Model Number				Lbs.	Ft.	Price	Features
	Right/Left Executive Lateral File U Desk	71	106.5	29	575	40.9	\$ 2150.00	<ul style="list-style-type: none"> • Locking box/box/file pedestal • Locking, two lateral file drawer pedestal • Pedestals ship set-up • Requires assembly
	700_-537538E							
	Consists of:							
	-821 Desk Shell	71	35.5	29	162	6.8	\$ 450.00	
	-831 B/B/F Pedestal	15.5	22	28	78	8.6	\$ 380.00	
	-823 Bridge	47.25	23.75	29	70	3.1	\$ 226.00	
	Right/Left Lateral File U Desk	71	101.25	29	570	40.3	\$ 2130.00	
	700_-537538							
	Consists of:							
	-821 Desk Shell	71	35.5	29	162	6.8	\$ 450.00	
	-831 B/B/F Pedestal	15.5	22	28	78	8.6	\$ 380.00	
	-923 Bridge	42	23.75	29	65	2.5	\$ 206.00	
	Right/Left Executive Bow Front U Desk	71	112.25	29	517	33.6	\$ 1829.00	<ul style="list-style-type: none"> • Locking box/box/file pedestal • Locking file/file pedestal • Pedestals ship set-up • Requires assembly
	700_-5758EB							
	Consists of:							
	-822 Desk Shell w/Bow Top	71	41.25	29	173	7.8	\$ 515.00	
	-831 B/B/F Pedestal	15.5	22	28	78	8.6	\$ 380.00	
	-823 Bridge	47.25	23.75	29	70	3.1	\$ 226.00	
	Right/Left Bow Front U Desk	71	107	29	512	33.0	\$ 1809.00	
	700_-5758B							
	Consists of:							
	-822 Desk Shell w/Bow Top	71	41.25	29	173	7.8	\$ 515.00	
	-831 B/B/F Pedestal	15.5	22	28	78	8.6	\$ 380.00	
	-923 Bridge	42	23.75	29	65	2.5	\$ 206.00	
	Right/Left Executive Bow Front U Desk with 3/4 Pedestals	71	112.25	29	487	29.6	\$ 1701.00	<ul style="list-style-type: none"> • Two locking box/file pedestals • Pedestals ship set-up • Requires assembly
	700_-5758EBQ							
	Consists of:							
	-822 Desk Shell w/Bow Top	71	41.25	29	173	7.8	\$ 515.00	
	-838 B/F 3/4 Pedestal	15.5	22.25	20.75	61	6.6	\$ 303.00	
	-823 Bridge	47.25	23.75	29	70	3.1	\$ 226.00	
	Right/Left Bow Front U Desk with 3/4 Pedestals	71	107	29	482	29.0	\$ 1681.00	
	700_-5758BQ							
	Consists of:							
	-822 Desk Shell w/Bow Top	71	41.25	29	173	7.8	\$ 515.00	
	-838 B/F 3/4 Pedestal	15.5	22.25	20.75	61	6.6	\$ 303.00	
	-923 Bridge	42	23.75	29	65	2.5	\$ 206.00	
	Right Bow Front U Desk with Corner Credenza	71	111.75	29	530	34.2	\$ 1925.00	<ul style="list-style-type: none"> • Locking box/box/file pedestal • Locking file/file pedestal • Pedestals ship set-up • Requires assembly
	700_-557B							
	Consists of:							
	-822 Desk Shell w/Bow Top	71	41.25	29	173	7.8	\$ 515.00	
	-831 B/B/F Pedestal	15.5	22	28	78	8.6	\$ 380.00	
	-623 Bridge	35	23.75	29	56	2.4	\$ 180.00	
	Left Bow Front U Desk with Corner Credenza	71	111.75	29	530	34.2	\$ 1925.00	
	700_-558B							
	Consists of:							
	-822 Desk Shell w/Bow Top	71	41.25	29	173	7.8	\$ 515.00	
	-831 B/B/F Pedestal	15.5	22	28	78	8.6	\$ 380.00	
	-623 Bridge	35	23.75	29	56	2.4	\$ 180.00	

Fairplex LAMINATE COLLECTION





FLEXSTEEL®
CONTRACT

7003 Grey / 7004 Mocha / 7005 Cognac Cherry / 7006 Mahogany / 7007 Walnut Finishes

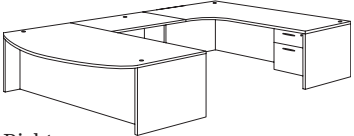
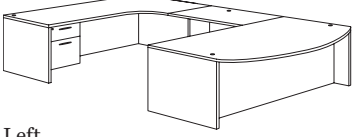
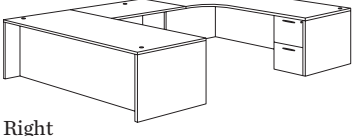
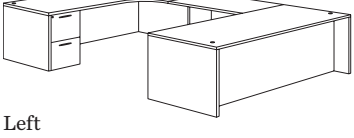
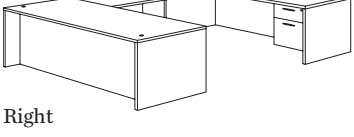
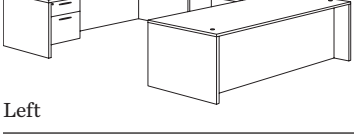
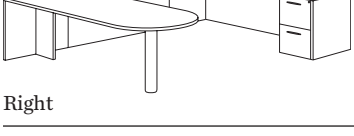
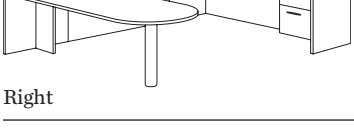
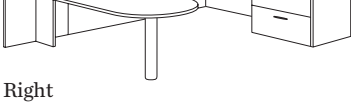
DMI COLLECTION

	Item Description	W"	D"	H"	Weight Lbs.	Cubic Ft.	List Price	Features
 Right	Right Bow Front U Desk with Corner Credenza with 3/4 Pedestals 700_-557BQ	71	111.75	29	500	30.2	\$ 1797.00	<ul style="list-style-type: none"> • Two locking box/file pedestals • Pedestals ship set-up • Requires assembly
	Consists of:							
	-822 Desk Shell w/Bow Top	71	41.25	29	173	7.8	\$ 515.00	
	-838 B/F 3/4 Pedestal	15.5	22.25	20.75	61	6.6	\$ 303.00	
	-623 Bridge	35	23.75	29	56	2.4	\$ 180.00	
	-621 Left Corner Credenza Shell	71	35.5	29	149	6.8	\$ 496.00	
-838 B/F 3/4 Pedestal	15.5	22.25	20.75	61	6.6	\$ 303.00		
 Left	Left Bow Front U Desk with Corner Credenza with 3/4 Pedestals 700_-558BQ	71	111.75	29	500	30.2	\$ 1797.00	
	Consists of:							
	-822 Desk Shell w/Bow Top	71	41.25	29	173	7.8	\$ 515.00	
	-838 B/F 3/4 Pedestal	15.5	22.25	20.75	61	6.6	\$ 303.00	
	-623 Bridge	35	23.75	29	56	2.4	\$ 180.00	
	-622 Right Corner Credenza Shell	71	35.5	29	149	6.8	\$ 496.00	
-838 B/F 3/4 Pedestal	15.5	22.25	20.75	61	6.6	\$ 303.00		
 Right	Right U Desk with Corner Credenza 700_-557	71	106	29	519	33.2	\$ 1860.00	<ul style="list-style-type: none"> • Locking box/box/file pedestal • Locking file/file pedestal • Pedestals ship set-up • Requires assembly
	Consists of:							
	-821 Desk Shell	71	35.5	29	162	6.8	\$ 450.00	
	-831 B/B/F Pedestal	15.5	22	28	78	8.6	\$ 380.00	
	-623 Bridge	35	23.75	29	56	2.4	\$ 180.00	
	-621 Left Corner Credenza Shell	71	35.5	29	149	6.8	\$ 496.00	
-832 F/F Pedestal	15.5	22	28	74	8.6	\$ 354.00		
 Left	Left U Desk with Corner Credenza 700_-558	71	106	29	519	33.2	\$ 1860.00	
	Consists of:							
	-821 Desk Shell	71	35.5	29	162	6.8	\$ 450.00	
	-831 B/B/F Pedestal	15.5	22	28	78	8.6	\$ 380.00	
	-623 Bridge	35	23.75	29	56	2.4	\$ 180.00	
	-622 Right Corner Credenza Shell	71	35.5	29	149	6.8	\$ 496.00	
-832 F/F Pedestal	15.5	22	28	74	8.6	\$ 354.00		
 Right	Right U Desk with Corner Credenza with 3/4 Pedestals 700_-557Q	71	106	29	489	29.2	\$ 1732.00	<ul style="list-style-type: none"> • Two locking box/file pedestals • Pedestals ship set-up • Requires assembly
	Consists of:							
	-821 Desk Shell	71	35.5	29	162	6.8	\$ 450.00	
	-838 B/F 3/4 Pedestal	15.5	22.25	20.75	61	6.6	\$ 303.00	
	-623 Bridge	35	23.75	29	56	2.4	\$ 180.00	
	-621 Left Corner Credenza Shell	71	35.5	29	149	6.8	\$ 496.00	
-838 B/F 3/4 Pedestal	15.5	22.25	20.75	61	6.6	\$ 303.00		
 Left	Left U Desk with Corner Credenza with 3/4 Pedestals 700_-558Q	71	106	29	489	29.2	\$ 1732.00	
	Consists of:							
	-821 Desk Shell	71	35.5	29	162	6.8	\$ 450.00	
	-838 B/F 3/4 Pedestal	15.5	22.25	20.75	61	6.6	\$ 303.00	
	-623 Bridge	35	23.75	29	56	2.4	\$ 180.00	
	-622 Right Corner Credenza Shell	71	35.5	29	149	6.8	\$ 496.00	
-838 B/F 3/4 Pedestal	15.5	22.25	20.75	61	6.6	\$ 303.00		
 Right	Right/Left Executive Bullet U Desk 700_-647648E	71	106.5	29	383	24.1	\$ 1396.00	<ul style="list-style-type: none"> • Locking file/file pedestal • Pedestal ships set-up • Requires assembly
	Consists of:							
	-620 Executive Bullet Desk Shell	71	35.5	29	108	5.8	\$ 372.00	
	-630 Bullet Support Ped	2.5	2.5	28	9	1.1	\$ 90.00	
	-823 Bridge	47.25	23.75	29	70	3.1	\$ 226.00	
	-825 Credenza Shell	71	23.75	29	122	5.5	\$ 354.00	
-832 F/F Pedestal	15.5	22	28	74	8.6	\$ 354.00		
 Right	Right/Left Executive Bullet U Desk with 3/4 Pedestal 700_-647648EQ	71	106.5	29	370	22.1	\$ 1345.00	<ul style="list-style-type: none"> • Locking box/file pedestal • Pedestal ships set-up • Requires assembly
	Consists of:							
	-620 Executive Bullet Desk Shell	71	35.5	29	108	5.8	\$ 372.00	
	-630 Bullet Support Ped	2.5	2.5	28	9	1.1	\$ 90.00	
	-823 Bridge	47.25	23.75	29	70	3.1	\$ 226.00	
	-825 Credenza Shell	71	23.75	29	122	5.5	\$ 354.00	
-838 B/F 3/4 Pedestal	15.5	22.25	20.75	61	6.6	\$ 303.00		
 Right	Right/Left Executive Bullet Lateral File U Desk 700_-507508E	71	106.5	29	452	32.4	\$ 1782.00	<ul style="list-style-type: none"> • Locking, two lateral file drawer pedestal • Pedestal ships set-up • Requires assembly
	Consists of:							
	-620 Executive Bullet Desk Shell	71	35.5	29	108	5.8	\$ 372.00	
	-630 Bullet Support Ped	2.5	2.5	28	9	1.1	\$ 90.00	
	-823 Bridge	47.25	23.75	29	70	3.1	\$ 226.00	
	-825 Credenza Shell	71	23.75	29	122	5.5	\$ 354.00	
-827 Lateral File Pedestal	35.5	22	29	143	16.9	\$ 740.00		

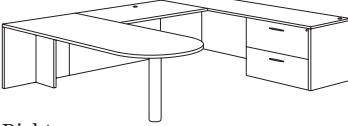

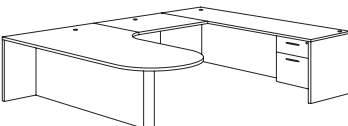
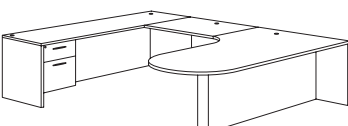
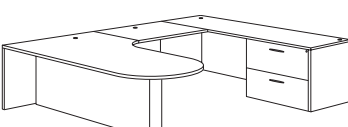
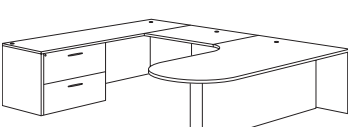
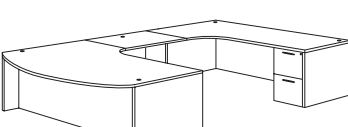
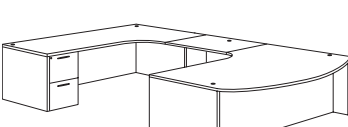
	Item Description	W"	D"	H"	Weight	Cubic	List	Features
	Model Number				Lbs.	Ft.	Price	
	Right/Left Bullet Lateral File U Desk	71	101.25	29	447	31.8	\$ 1762.00	<ul style="list-style-type: none"> • Locking, two lateral file drawer pedestal • Pedestal ships set-up • Requires assembly
	700_-507508							
	Consists of:							
	-620 Executive Bullet Desk Shell	71	35.5	29	108	5.8	\$ 372.00	
	-630 Bullet Support Ped	2.5	2.5	28	9	1.1	\$ 90.00	
	-923 Bridge	42	23.75	29	65	2.5	\$ 206.00	
Right	-825 Credenza Shell	71	23.75	29	122	5.5	\$ 354.00	
	-827 Lateral File Pedestal	35.5	22	29	143	16.9	\$ 740.00	
	Right Executive Corner Peninsula/Bullet U Desk	71	100.75	29	397	25.2	\$ 1557.00	<ul style="list-style-type: none"> • Locking file/file pedestal • Pedestal ships set-up • Requires assembly
	700_-647CP							
	Consists of:							
	-222 Right Corner Pen/Bullet Shell	71	42	29	139	8.0	\$ 521.00	
	-230 Corner Pen/Bullet Base	2.5	2.5	28	6	0.7	\$ 148.00	
	-623 Bridge	35	23.75	29	56	2.4	\$ 180.00	
Right	-825 Credenza Shell	71	23.75	29	122	5.5	\$ 354.00	
	-832 F/F Pedestal	15.5	22	28	74	8.6	\$ 354.00	
	Left Executive Corner Peninsula/Bullet U Desk	71	100.75	29	397	25.2	\$ 1557.00	
	700_-648CP							
	Consists of:							
	-221 Left Corner Pen/Bullet Shell	71	42	29	139	8.0	\$ 521.00	
	-230 Corner Pen/Bullet Base	2.5	2.5	28	6	0.7	\$ 148.00	
	-623 Bridge	35	23.75	29	56	2.4	\$ 180.00	
Left	-825 Credenza Shell	71	23.75	29	122	5.5	\$ 354.00	
	-832 F/F Pedestal	15.5	22	28	74	8.6	\$ 354.00	
	Right Executive Corner Peninsula/Bullet U Desk with 3/4 Pedestals	71	100.75	29	384	23.2	\$ 1506.00	<ul style="list-style-type: none"> • Locking box/file pedestal • Pedestal ships set-up • Requires assembly
	700_-647CPQ							
	Consists of:							
	-222 Right Corner Pen/Bullet Shell	71	42	29	139	8.0	\$ 521.00	
	-230 Corner Pen/Bullet Base	2.5	2.5	28	6	0.7	\$ 148.00	
	-623 Bridge	35	23.75	29	56	2.4	\$ 180.00	
Right	-825 Credenza Shell	71	23.75	29	122	5.5	\$ 354.00	
	-838 B/F 3/4 Pedestal	15.5	22.25	20.75	61	6.6	\$ 303.00	
	Left Executive Corner Peninsula/Bullet U Desk with 3/4 Pedestals	71	100.75	29	384	23.2	\$ 1506.00	
	700_-648CPQ							
	Consists of:							
	-221 Left Corner Pen/Bullet Shell	71	42	29	139	8.0	\$ 521.00	
	-230 Corner Pen/Bullet Base	2.5	2.5	28	6	0.7	\$ 148.00	
	-623 Bridge	35	23.75	29	56	2.4	\$ 180.00	
Left	-825 Credenza Shell	71	23.75	29	122	5.5	\$ 354.00	
	-838 B/F 3/4 Pedestal	15.5	22.25	20.75	61	6.6	\$ 303.00	
	Right Executive Corner Peninsula/Bullet Lateral File U Desk	71	100.75	29	466	33.5	\$ 1943.00	<ul style="list-style-type: none"> • Locking, two lateral file drawer pedestal • Pedestal ships set-up • Requires assembly
	700_-507CP							
	Consists of:							
	-222 Right Corner Pen/Bullet Shell	71	42	29	139	8.0	\$ 521.00	
	-230 Corner Pen/Bullet Base	2.5	2.5	28	6	0.7	\$ 148.00	
	-623 Bridge	35	23.75	29	56	2.4	\$ 180.00	
Right	-825 Credenza Shell	71	23.75	29	122	5.5	\$ 354.00	
	-827 Lateral File Pedestal	35.5	22	29	143	16.9	\$ 740.00	
	Left Executive Corner Peninsula/Bullet Lateral File U Desk	71	100.75	29	466	33.5	\$ 1943.00	
	700_-508CP							
	Consists of:							
	-221 Left Corner Pen/Bullet Shell	71	42	29	139	8.0	\$ 521.00	
	-230 Corner Pen/Bullet Base	2.5	2.5	28	6	0.7	\$ 148.00	
	-623 Bridge	35	23.75	29	56	2.4	\$ 180.00	
Left	-825 Credenza Shell	71	23.75	29	122	5.5	\$ 354.00	
	-827 Lateral File Pedestal	35.5	22	29	143	16.9	\$ 740.00	
	Right Executive Work Station U Desk	71	118.5	29	541	35.4	\$ 1996.00	<ul style="list-style-type: none"> • Locking box/box/file pedestal • Locking file/file pedestal • Pedestals ship set-up • Requires assembly
	700_-847							
	Consists of:							
	-322 RT Corner Desk Shell w/Bow	71	48	29	184	9.0	\$ 586.00	
	-831 B/B/F Pedestal	15.5	22	28	78	8.6	\$ 380.00	
	-623 Bridge	35	23.75	29	56	2.4	\$ 180.00	
Right	-621 Left Corner Credenza Shell	71	35.5	29	149	6.8	\$ 496.00	
	-832 F/F Pedestal	15.5	22	28	74	8.6	\$ 354.00	
	Left Executive Work Station U Desk	71	118.5	29	541	35.4	\$ 1996.00	
	700_-848							
	Consists of:							
	-321 LT Corner Desk Shell w/Bow	71	48	29	184	9.0	\$ 586.00	
	-831 B/B/F Pedestal	15.5	22	28	78	8.6	\$ 380.00	
	-623 Bridge	35	23.75	29	56	2.4	\$ 180.00	
Left	-622 Right Corner Credenza Shell	71	35.5	29	149	6.8	\$ 496.00	
	-832 F/F Pedestal	15.5	22	28	74	8.6	\$ 354.00	

Fairplex LAMINATE COLLECTION



FLEXSTEEL®
CONTRACT

7003 Grey / 7004 Mocha / 7005 Cognac Cherry / 7006 Mahogany / 7007 Walnut Finishes

DMI COLLECTION

Item Description	Model Number	W"	D"	H"	Weight Lbs.	Cubic Ft.	List Price	Features
Right Executive Work Station U Desk with 3/4 Pedestal	700_-847Q	71	118.5	29	511	31.4	\$ 1868.00	<ul style="list-style-type: none"> • Two locking box/file pedestals • Pedestals ship set-up • Requires assembly
Consists of:								
-322 RT Corner Desk Shell w/Bow	71	48	29	184	9.0	\$	586.00	
-838 B/F 3/4 Pedestal	15.5	22.25	20.75	61	6.6	\$	303.00	
-623 Bridge	35	23.75	29	56	2.4	\$	180.00	
-621 Left Corner Credenza Shell	71	35.5	29	149	6.8	\$	496.00	
-838 B/F 3/4 Pedestal	15.5	22.25	20.75	61	6.6	\$	303.00	
Left Executive Work Station U Desk with 3/4 Pedestal	700_-848Q	71	118.5	29	511	31.4	\$ 1868.00	
Consists of:								
-321 LT Corner Desk Shell w/Bow	71	48	29	184	9.0	\$	586.00	
-838 B/F 3/4 Pedestal	15.5	22.25	20.75	61	6.6	\$	303.00	
-623 Bridge	35	23.75	29	56	2.4	\$	180.00	
-622 Right Corner Credenza Shell	71	35.5	29	149	6.8	\$	496.00	
-838 B/F 3/4 Pedestal	15.5	22.25	20.75	61	6.6	\$	303.00	
Executive Desk / Storage Suite	700_-901W	71	111.25	65	726	53.9	\$ 2901.00	<ul style="list-style-type: none"> • Locking box/box/file pedestal • Locking file/file pedestal • Locking, two lateral file drawer pedestal • Two cabinets in overhead • Pedestal ships set-up • Requires assembly
Consists of:								
-822 Bow Front Desk Shell	71	41.25	29	173	7.8	\$	515.00	
-831 B/B/F Pedestal	15.5	22	28	78	8.6	\$	380.00	
-832 F/F Pedestal	15.5	22	28	74	8.6	\$	354.00	
-827 Lateral File Pedestal	35.5	22	29	143	16.9	\$	740.00	
-540 Two Door Cabinet	35.5	22.75	29	118	4.9	\$	393.00	
-427L Laminate Door Overhead	71	15	36	140	7.1	\$	519.00	
Executive Desk / Storage Suite with Frosted Glass Overhead	700_-901G	71	111.25	65	728	53.9	\$ 2983.00	<ul style="list-style-type: none"> • Locking box/box/file pedestal • Locking file/file pedestal • Locking, two lateral file drawer pedestal • Two-door cabinet • Two cabinets in overhead • Drawer pedestals ship set-up • Requires assembly
Consists of:								
-822 Bow Front Desk Shell	71	41.25	29	173	7.8	\$	515.00	
-831 B/B/F Pedestal	15.5	22	28	78	8.6	\$	380.00	
-832 F/F Pedestal	15.5	22	28	74	8.6	\$	354.00	
-827 Lateral File Pedestal	35.5	22	29	143	16.9	\$	740.00	
-540 Two Door Cabinet	35.5	22.75	29	118	4.9	\$	393.00	
-428FG Frosted Glass Overhead	71	15	36	142	7.1	\$	601.00	
Executive Desk / Storage Suite with White Glass Overhead	700_-901WG	71	111.25	65	728	53.9	\$ 3251.00	
Consists of:								
-822 Bow Front Desk Shell	71	41.25	29	173	7.8	\$	515.00	
-831 B/B/F Pedestal	15.5	22	28	78	8.6	\$	380.00	
-832 F/F Pedestal	15.5	22	28	74	8.6	\$	354.00	
-827 Lateral File Pedestal	35.5	22	29	143	16.9	\$	740.00	
-540 Two Door Cabinet	35.5	22.75	29	118	4.9	\$	393.00	
-429WG White Glass Overhead	71	15	36	142	7.1	\$	869.00	



DMI COLLECTION

7003 Grey / 7004 Mocha / 7005 Cognac Cherry / 7006 Mahogany / 7007 Walnut Finishes

Item Description	W"	D"	H"	Weight	Cubic	List	Features
Model Number				Lbs.	Ft.	Price	
Right Deluxe Executive Peninsula U Workstation							
700_-707W	106.5	106.5	65	760	52.7	\$ 3029.00	<ul style="list-style-type: none"> • Locking file/file pedestal • Locking, two lateral file drawer pedestal • Two cabinets in overhead • Pedestal ships set-up • Requires assembly
Consists of:							
-620 Executive Bullet Desk Shell	71	35.5	29	108	5.8	\$ 372.00	
-630 Bullet Support Ped	2.5	2.5	29	9	1.1	\$ 90.00	
-623 Bridge	35	23.75	29	56	2.4	\$ 180.00	
-621 Left Corner Credenza Shell	71	35.5	29	149	6.8	\$ 496.00	
-832 F/F Pedestal	15.5	22	28	74	8.6	\$ 354.00	
-427L Laminate Door Overhead	71	15	36	140	7.1	\$ 519.00	
-827 Lateral File	35.5	22	29	143	16.9	\$ 740.00	
-328 Open Overhead	35.5	15	36	81	4.0	\$ 278.00	

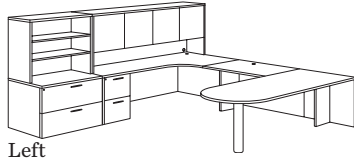
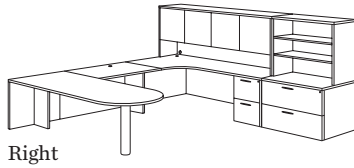

Left Deluxe Executive Peninsula U Workstation							
700_-708W	106.5	106.5	65	760	52.7	\$ 3029.00	
Consists of:							
-620 Executive Bullet Desk Shell	71	35.5	29	108	5.8	\$ 372.00	
-630 Bullet Support Ped	2.5	2.5	29	9	1.1	\$ 90.00	
-623 Bridge	35	23.75	29	56	2.4	\$ 180.00	
-622 Right Corner Credenza Shell	71	35.5	29	149	6.8	\$ 496.00	
-832 F/F Pedestal	15.5	22	28	74	8.6	\$ 354.00	
-427L Laminate Door Overhead	71	15	36	140	7.1	\$ 519.00	
-827 Lateral File	35.5	22	29	143	16.9	\$ 740.00	
-328 Open Overhead	35.5	15	36	81	4.0	\$ 278.00	

Right Deluxe Executive Peninsula U Workstation with Frosted Glass Overhead							
700_-707G	106.5	106.5	65	762	52.7	\$ 3111.00	<ul style="list-style-type: none"> • Locking file/file pedestal • Locking, two lateral file drawer pedestal • Two cabinets in overhead • Pedestal ships set-up • Requires assembly
Consists of:							
-620 Executive Bullet Desk Shell	71	35.5	29	108	5.8	\$ 372.00	
-630 Bullet Support Ped	2.5	2.5	29	9	1.1	\$ 90.00	
-623 Bridge	35	23.75	29	56	2.4	\$ 180.00	
-621 Left Corner Credenza Shell	71	35.5	29	149	6.8	\$ 496.00	
-832 F/F Pedestal	15.5	22	28	74	8.6	\$ 354.00	
-428FG Frosted Door Overhead	71	15	36	142	7.1	\$ 601.00	
-827 Lateral File	35.5	22	29	143	16.9	\$ 740.00	
-328 Open Overhead	35.5	15	36	81	4.0	\$ 278.00	

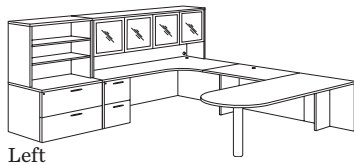
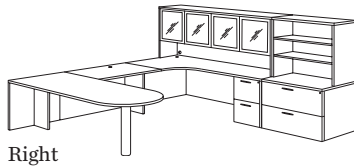

Left Deluxe Executive Peninsula U Workstation with Frosted Glass Overhead							
700_-708G	106.5	106.5	65	762	52.7	\$ 3111.00	
Consists of:							
-620 Executive Bullet Desk Shell	71	35.5	29	108	5.8	\$ 372.00	
-630 Bullet Support Ped	2.5	2.5	29	9	1.1	\$ 90.00	
-623 Bridge	35	23.75	29	56	2.4	\$ 180.00	
-622 Right Corner Credenza Shell	71	35.5	29	149	6.8	\$ 496.00	
-832 F/F Pedestal	15.5	22	28	74	8.6	\$ 354.00	
-428FG Frosted Door Overhead	71	15	36	142	7.1	\$ 601.00	
-827 Lateral File	35.5	22	29	143	16.9	\$ 740.00	
-328 Open Overhead	35.5	15	36	81	4.0	\$ 278.00	

Right Deluxe Executive Peninsula U Workstation with White Glass Overhead							
700_-707WG	106.5	106.5	65	762	52.7	\$ 3379.00	
Consists of:							
-620 Executive Bullet Desk Shell	71	35.5	29	108	5.8	\$ 372.00	
-630 Bullet Support Ped	2.5	2.5	29	9	1.1	\$ 90.00	
-623 Bridge	35	23.75	29	56	2.4	\$ 180.00	
-621 Left Corner Credenza Shell	71	35.5	29	149	6.8	\$ 496.00	
-832 F/F Pedestal	15.5	22	28	74	8.6	\$ 354.00	
-429WG White Door Overhead	71	15	36	142	7.1	\$ 869.00	
-827 Lateral File	35.5	22	29	143	16.9	\$ 740.00	
-328 Open Overhead	35.5	15	36	81	4.0	\$ 278.00	

Left Deluxe Executive Peninsula U Workstation with White Glass Overhead							
700_-708WG	106.5	106.5	65	762	52.7	\$ 3379.00	
Consists of:							
-620 Executive Bullet Desk Shell	71	35.5	29	108	5.8	\$ 372.00	
-630 Bullet Support Ped	2.5	2.5	29	9	1.1	\$ 90.00	
-623 Bridge	35	23.75	29	56	2.4	\$ 180.00	
-622 Right Corner Credenza Shell	71	35.5	29	149	6.8	\$ 496.00	
-832 F/F Pedestal	15.5	22	28	74	8.6	\$ 354.00	
-429WG White Door Overhead	71	15	36	142	7.1	\$ 869.00	
-827 Lateral File	35.5	22	29	143	16.9	\$ 740.00	
-328 Open Overhead	35.5	15	36	81	4.0	\$ 278.00	

Fairplex LAMINATE COLLECTION



FLEXSTEEL®
CONTRACT

7003 Grey / 7004 Mocha / 7005 Cognac Cherry / 7006 Mahogany / 7007 Walnut Finishes

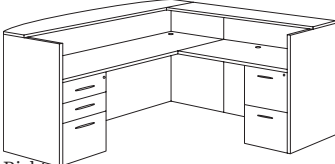
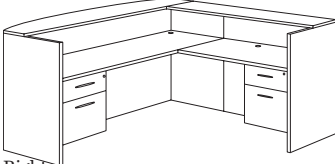
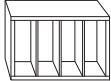
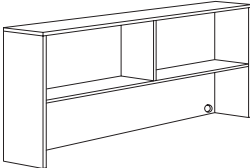
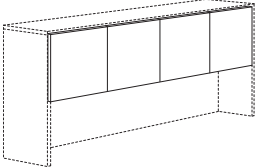
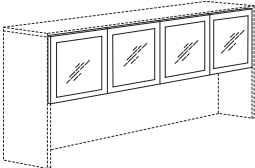

DMI COLLECTION

Item Description	Weight	Cubic	List	Features	
Model Number	W" D" H"	Lbs.	Ft.	Price	
 <p>Right/Left Reception L Desk 700_-6667 Consists of:</p>	71 78 41	483	31.6 \$	1945.00	<ul style="list-style-type: none"> • Locking box/box/file pedestal • Locking file/file pedestal • Pedestals ship set-up • Requires assembly
-122 Reception Desk Shell	71 36 41	207	8.9 \$	682.00	
-831 B/B/F Pedestal	15.5 22 28	78	8.6 \$	380.00	
-124 Reception Return Shell	42 22.75 40	100	4.4 \$	329.00	
-125 Return Riser	60 12 1	24	1.1 \$	200.00	
-832 F/F Pedestal	15.5 22 28	74	8.6 \$	354.00	
 <p>Right/Left Reception L Desk with 3/4 Pedestals 700_-6667Q Consists of:</p>	71 78 41	483	31.6 \$	1817.00	<ul style="list-style-type: none"> • Two locking box/file pedestals • Pedestals ship set-up • Requires assembly
-122 Reception Desk Shell	71 36 41	207	8.9 \$	682.00	
-838 B/F 3/4 Pedestal	15.5 22.25 20.75	61	6.6 \$	303.00	
-124 Reception Return Shell	42 22.75 40	100	4.4 \$	329.00	
-125 Return Riser	60 12 1	24	1.1 \$	200.00	
-838 B/F 3/4 Pedestal	15.5 22.25 20.75	61	6.6 \$	303.00	
 <p>Organizer 700_-53</p>	12 13 18	23	1.3 \$	151.00	<ul style="list-style-type: none"> • Divided storage • Designed for use with reception desks • Requires assembly
 <p>Open Overhead 700_-426 700_-922</p>	71 15 36 66 15 36	133 121	5.6 \$ 5.2 \$	410.00 383.00	<ul style="list-style-type: none"> • -426 use with -21, -825, -621, -622 • -922 use with -19, -925 • Requires assembly
 <p>71" Overhead with Laminate Doors 700_-427L Consists of:</p>	71 15 36	140	7.1 \$	519.00	<ul style="list-style-type: none"> • Two cabinets • -427L use with -21, -825, -621, -622 • -927L use with -19, -925 • Requires assembly
-426 Open Overhead	71 15 36	133	5.6 \$	410.00	
-4271 Laminate Doors		7	1.5 \$	109.00	
<p>66" Overhead with Laminate Doors 700_-927L Consists of:</p>	66 15 36	128	6.6 \$	487.00	
-922 Open Overhead	66 15 36	121	5.2 \$	383.00	
-9271 Laminate Doors		7	1.4 \$	104.00	
 <p>71" Overhead with Laminate Framed Frosted Glass Doors 700_-428FG Consists of:</p>	71 15 36	142	7.1 \$	601.00	<ul style="list-style-type: none"> • Two cabinets • -428FG, -429WG use with -21, -825, -621, -622 • -928FG, -929WG use with -19, -925 • Requires assembly
-426 Open Overhead	71 15 36	133	5.6 \$	410.00	
-4281 Frosted Glass Doors		9	1.5 \$	191.00	
<p>71" Overhead with Metal Framed White Glass Doors 700_-429WG Consists of:</p>	71 15 36	142	7.1 \$	869.00	
-426 Open Overhead	71 15 36	133	5.6 \$	410.00	
-4291 White Glass Doors		9	1.5 \$	459.00	
<p>66" Overhead with Laminate Framed Frosted Glass Doors 700_-928FG Consists of:</p>	66 15 36	128	6.6 \$	563.00	
-922 Open Overhead	66 15 36	121	5.2 \$	383.00	
-9281 Frosted Glass Doors		7	1.4 \$	180.00	
<p>66" Overhead with Metal Framed White Glass Doors 700_-929WG Consists of:</p>	66 15 36	128	5.6 \$	820.00	
-922 Open Overhead	66 15 36	121	5.2 \$	383.00	
-9291 White Glass Doors		7	1.4 \$	437.00	

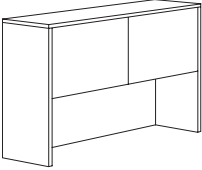
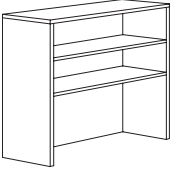
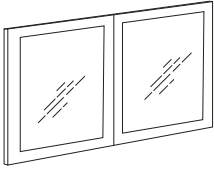
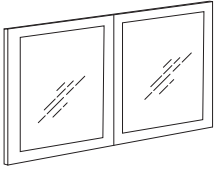
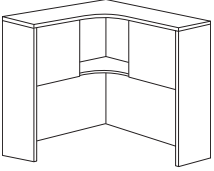
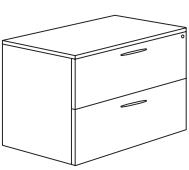

DMI COLLECTION

7003 Grey / 7004 Mocha / 7005 Cognac Cherry / 7006 Mahogany / 7007 Walnut Finishes

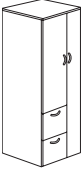
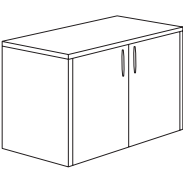
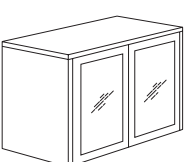
Item Description	W"	D"	H"	Weight Lbs.	Cubic Ft.	List Price	Features
 <p>Overhead with Two Doors 700_-326</p>	48	15	36	101	4.6	\$ 334.00	<ul style="list-style-type: none"> • For use with -824 • Requires assembly
 <p>Open Overhead 700_-328</p>	35.5	15	36	81	4.0	\$ 278.00	<ul style="list-style-type: none"> • For use with -540, -827 • Requires assembly
 <p>Frosted Glass Door Kit for Open Overhead 7001-3281</p>	36	2	18	20	4.0	\$ 269.00	<ul style="list-style-type: none"> • For use with -328
 <p>White Glass Door Kit for Open Overhead 7001-3291</p>	36	2	18	20	4.0	\$ 525.00	
 <p>Corner Overhead 700_-331</p>	42	42	36	142	5.4	\$ 508.00	<ul style="list-style-type: none"> • For use with -330 • Requires assembly
 <p>Lateral File 700_-827</p>	35.5	22	29	143	16.9	\$ 740.00	<ul style="list-style-type: none"> • Top can be removed for use as a pedestal - with top removed the height is 28" • Centrally locking drawers • Ships set-up
 <p>Four Drawer Lateral File 700_-17</p>	35.5	22.5	55	270	35.2	\$ 1502.00	<ul style="list-style-type: none"> • Centrally locking drawers • Anti-tip device • Ships set-up
 <p>Storage Wardrobe Cabinet 700_-05</p>	24	23.5	65	216	26.2	\$ 1363.00	<ul style="list-style-type: none"> • Two file drawers • Cabinet with two adjustable shelves • Cabinet with hanger rod • Ships set-up
 <p>Two Door Cabinet 700_-540</p>	35.5	22.75	29	118	4.9	\$ 393.00	<ul style="list-style-type: none"> • Requires assembly
 <p>Two Door Cabinet with Frosted Glass 700_-541</p> <p>Consists of:</p>	35.5	22.75	29	135	6.5	\$ 608.00	<ul style="list-style-type: none"> • This kit is an upgrade for the -540 Two Door Cabinet and customers must install doors themselves
<p>-540 Two Door Cabinet</p>	35.5	22.75	29	118	4.9	\$ 393.00	<ul style="list-style-type: none"> • Requires assembly
<p>7001-5411 Frosted Glass Doors</p>	28	17	2	17	1.6	\$ 215.00	





Fairplex LAMINATE COLLECTION



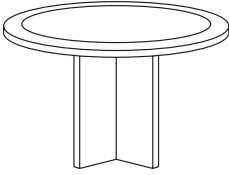
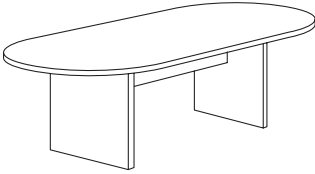
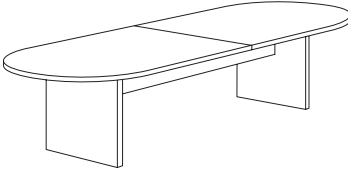
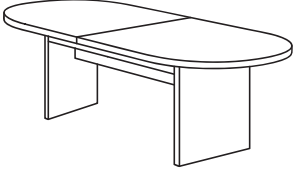

FLEXSTEEL®
CONTRACT

7003 Grey / 7004 Mocha / 7005 Cognac Cherry / 7006 Mahogany / 7007 Walnut Finishes

DMI COLLECTION

	Item Description	W"	D"	H"	Weight Lbs.	Cubic Ft.	List Price	Features
	Frosted Glass Door Kit for Cabinet 7001-5411	28	17	2	17	1.6	\$ 215.00	• For use with -540 two door cabinet
	White Glass Door Kit for Cabinet 7001-5421	28	17	2	17	1.8	\$ 445.00	
	Bookcase 700_-828	35.5	15	42	98	4.3	\$ 321.00	• Requires assembly
	Bookcase 700_-829	35.5	15	65	150	6.6	\$ 448.00	• Requires assembly
	36" Round Conference Table 700_-725	36	36	29	65	3.2	\$ 335.00	• Requires assembly
	42" Round Conference Table 700_-726	42	42	29	95	6.3	\$ 361.00	
	47" Round Conference Table 700_-721	47	47	29	109	7.9	\$ 432.00	
	6' Racetrack Conference Table 700_-720	71	35	29	139	6.7	\$ 470.00	• Requires assembly
	8' Racetrack Conference Table 700_-723	95	42	29	189	10.8	\$ 663.00	
	10' Racetrack Conference Table 700_-727	120	48	29	246	11.3	\$ 921.00	• Requires assembly
	Consists of:							
	-728 Two Piece Top with Bases	120	48	29	222	10.0	\$ 753.00	
	-729 120" Stretcher				24	1.3	\$ 168.00	
	8' Racetrack Expandable Conference Table 700_-96EX	96	48	30	235	8.4	\$ 893.00	• Requires assembly
	Consists of:							
	-9031 Left & Right Top	48	48		150	5.2	\$ 541.00	
	-9033 Base (2 needed)				60	2.2	\$ 238.00	
	-9034 48" Rail Set				25	1.0	\$ 114.00	
	10' Racetrack Expandable Conference Table 700_-120EX	120	48	30	270	11.0	\$ 1091.00	• Requires assembly
	Consists of:							
	-9030 Left & Right Top	60	48		180	6.5	\$ 688.00	
	-9033 Base (2 needed)				60	2.2	\$ 238.00	
	-9038 72" Rail Set for 10' Table				30	2.3	\$ 165.00	

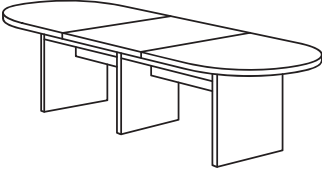
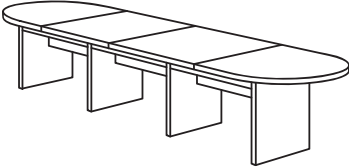
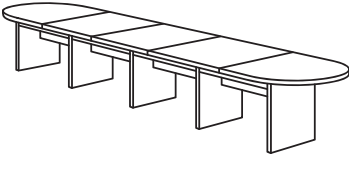
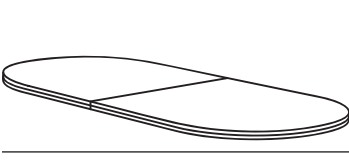

Item Description	W"	D"	H"	Weight Lbs.	Cubic Ft.	List Price	Features
 12' Racetrack Expandable Conference Table 700_-144EX Consists of: -9031 Left & Right Top -9032 Center Top & Rails -9033 Base (3 needed) -9034 48" Rail Set (2 needed)	144	48	30	385	15.7	\$ 1563.00	• Requires assembly
 14' Racetrack Expandable Conference Table 700_-168EX Consists of: -9030 Left & Right Top -9032 Center Top & Rails -9033 Base (3 needed) -9037 60" Rail Set (2 needed)	168	48	30	421	17.4	\$ 1776.00	
 16' Racetrack Expandable Conference Table 700_-192EX Consists of: -9031 Left & Right Top -9032 Center Top & Rails (2 needed) -9033 Base (4 needed) -9034 48" Rail Set (2 needed)	192	48	30	510	22.0	\$ 2119.00	• Requires assembly
 18' Racetrack Expandable Conference Table 700_-216EX Consists of: -9030 Left & Right Top -9032 Center Top & Rails (2 needed) -9033 Base (4 needed) -9037 60" Rail Set (2 needed)	216	48	30	546	23.7	\$ 2332.00	
 20' Racetrack Expandable Conference Table 700_-240EX Consists of: -9031 Left & Right Top -9032 Center Top & Rails (3 needed) -9033 Base (5 needed) -9034 48" Rail Set (2 needed)	240	48	30	635	28.3	\$ 2675.00	• Requires assembly
22' Racetrack Expandable Conference Table 700_-264EX Consists of: -9030 Left & Right Top -9032 Center Top & Rails (3 needed) -9033 Base (5 needed) -9037 60" Rail Set (2 needed)	264	48	30	671	30.0	\$ 2888.00	
Left & Right Section Race Track Expandable Conference Table Tops 700_-9030 700_-9031	120	48		180	6.5	\$ 688.00	• -9030 includes two 60" section tops • -9031 includes two 48" section tops
48" Center Section Expandable Conference Table Top and Rails 700_-9032	48	48		95	5.2	\$ 437.00	• Includes 44" rails
Expandable Conference Table Base 700_-9033				30	1.1	\$ 119.00	



Fairplex LAMINATE COLLECTION



FLEXSTEEL®
CONTRACT

7003 Grey / 7004 Mocha / 7005 Cognac Cherry / 7006 Mahogany / 7007 Walnut Finishes

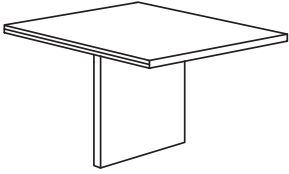
DMI COLLECTION

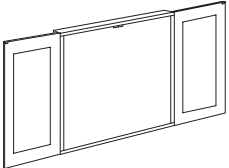
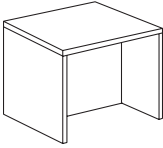
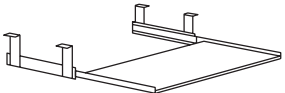
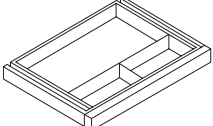
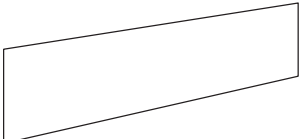
Item Description	W"	D"	H"	Weight Lbs.	Cubic Ft.	List Price	Features
 <p>48" Center Section Top and Base 700_-903233 Consists of: -9032 Center Top & Rails -9033 Base</p>	48	48	30	125	6.3	\$ 556.00	<ul style="list-style-type: none"> • Requires assembly
<p>Expandable Conference Table Rail Sets</p> <p>700_-9034 700_-9037 700_-9038</p>				25 28 30	1.0 1.2 2.3	\$ 114.00 \$ 147.00 \$ 165.00	<ul style="list-style-type: none"> • -9034 rail set for left & right 48" section tops • -9037 rail set for left & right 60" section tops • -9038 rail set for 10' expandable conference table
 <p>Buffet 700_-25</p>	64.5	22.5	36	200	4.1	\$ 1961.00	<ul style="list-style-type: none"> • Two, felt-lined, fully extending drawers with one having a silverware holder • Two cabinets, each with an adjustable shelf • Four heavy duty locking casters • Ships set-up • Optional 0000-40 Power Center (see Accessories section) is ideal when using a TV or other electronics with the buffet
 <p>Presentation Board 700_-650</p>	47	5	47	126	27.8	\$ 1164.00	<ul style="list-style-type: none"> • Open: 94" x 4.25" x 47" • Features a white magnetic marker board and a black fabric tack board on the interior of each door • Ships set-up
 <p>End Table 700_-131</p>	24	24	20	50	2.1	\$ 173.00	<ul style="list-style-type: none"> • Requires assembly
 <p>Keyboard Slide 700_-510</p>	24	12	1	13	0.3	\$ 87.00	
 <p>Center Drawer 700_-70</p>	26	12	1	15	0.7	\$ 66.00	
 <p>Cloth Tack Boards 0000-101 0000-102 0000-103</p>	68 63 44.5	1.5 1.5 1.5	18 18 18	25 25 25	1.8 1.6 1.2	\$ 419.00 \$ 393.00 \$ 321.00	<ul style="list-style-type: none"> • Use the -101 with the -426, -427, -428 • Use the -102 with the -927, -928 • Use the -103 with the -326



DMI COLLECTION

7003 Grey / 7004 Mocha / 7005 Cognac Cherry / 7006 Mahogany / 7007 Walnut Finishes

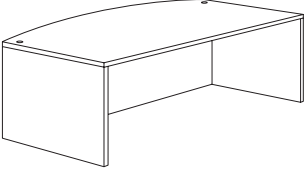
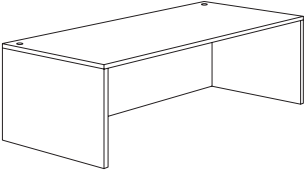
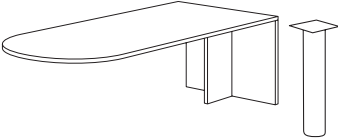
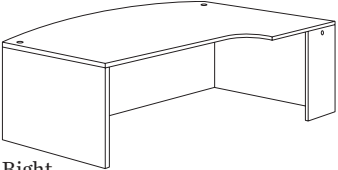
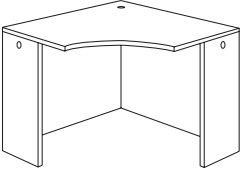
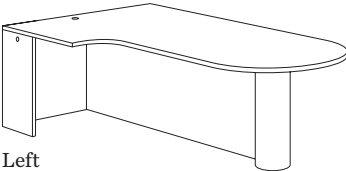
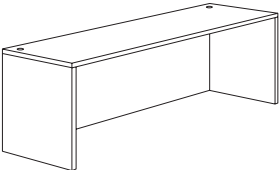
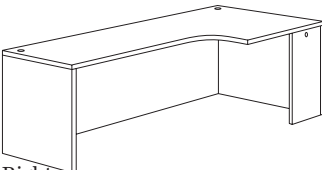
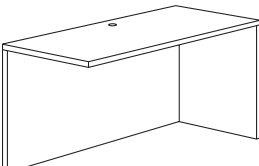
	Item Description	W"	D"	H"	Weight	Cubic	List	Features
	Model Number				Lbs.	Ft.	Price	
	Bow Front Desk Shell 700_-822	71	41.25	29	173	7.8	\$ 515.00	• Requires assembly
	Desk Shells 700_-821 700_-921 700_-121 700_-421 700_-120 700_-111	71 66 60 47.25 48 42	35.5 30 30 30 24 24	29 29 29 29 29 29	162 136 128 110 80 65	6.8 5.5 5.0 4.9 3.2 3.2	\$ 450.00 \$ 405.00 \$ 386.00 \$ 367.00 \$ 299.00 \$ 284.00	• Requires assembly
	Executive Bullet Desk Shells 700_-620 700_-520	71 66	35.5 30	29 29	108 125	5.8 3.8	\$ 372.00 \$ 315.00	• -620 and -520 require -630 support base • Requires assembly
	Bullet Support Post 700_-630	2.5	2.5	28	9	1.1	\$ 90.00	
	Left Corner Bow Front Desk Shell 700_-321	71	48	29	184	9.0	\$ 586.00	• -321 accommodates left return or credenza • -322 accommodates right return or credenza • Requires assembly
	Right Corner Bow Front Desk Shell 700_-322	71	48	29	184	9.0	\$ 586.00	
Right								
	Corner Desk Shell 700_-330	42	42	29	125	5.3	\$ 412.00	• Requires assembly
	Left Corner Bullet Desk Shell 700_-221	71	42	29	139	8.0	\$ 521.00	• -221 accommodates left return or credenza • -222 accommodates right return or credenza • -221/-222 require -230 support base • Requires assembly
	Right Corner Bullet Desk Shell 700_-222	71	42	29	139	8.0	\$ 521.00	
Left	Bullet Desk Support Base 700_-230	2.5	2.5	28	6	0.7	\$ 148.00	
	Credenza Shells 700_-825 700_-925 700_-926	71 66 60	23.75 23.75 23.75	29 29 29	122 116 106	5.5 4.9 3.6	\$ 354.00 \$ 345.00 \$ 303.00	• Requires assembly
	Left Corner Credenza Shells 700_-621 700_-521	71 66	35.5 35.5	29 29	149 125	6.8 5.4	\$ 496.00 \$ 489.00	• -621 & -521 For use in right U applications • -622 & -522 For use in left U applications • Requires assembly
	Right Corner Credenza Shells 700_-622 700_-522	71 66	35.5 35.5	29 29	149 125	6.8 5.4	\$ 496.00 \$ 489.00	
Right								
	Return Shells 700_-824 700_-924 700_-224 700_-324 700_-624	47.25 42 42 35.5 30	23.75 23.75 19.75 23.75 24	29 29 29 29 29	90 78 88 74 50	4.1 3.2 3.7 3.1 2.3	\$ 303.00 \$ 296.00 \$ 314.00 \$ 239.00 \$ 199.00	• Requires assembly





Fairplex LAMINATE COLLECTION

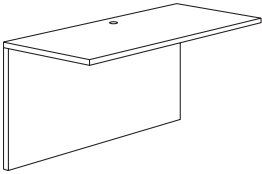
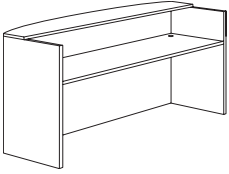
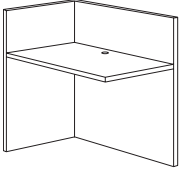

FLEXSTEEL®
CONTRACT

7003 Grey / 7004 Mocha / 7005 Cognac Cherry / 7006 Mahogany / 7007 Walnut Finishes

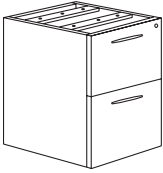
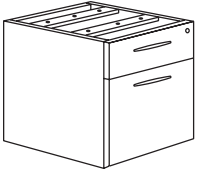
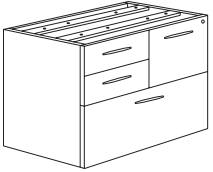
DMI COLLECTION

Item Description	W"	D"	H"	Weight Lbs.	Cubic Ft.	List Price	Features
 Bridge Shells							• Requires assembly
700_-823	47.25	23.75	29	70	3.1	\$ 226.00	
700_-923	42	23.75	29	65	23.5	\$ 206.00	
700_-623	35	23.75	29	56	2.4	\$ 180.00	
700_-523	30	23.75	29	52	2.0	\$ 157.00	
 Reception Desk Shell							• Requires assembly
700_-122	71	36	41	207	8.9	\$ 682.00	
 Reception Return Shell							• Requires assembly
700_-124	42	22.75	40	100	4.4	\$ 329.00	
 Reception Return Transaction Riser Top							
700_-125	60	12	1	24	1.1	\$ 200.00	
 Box/Box/File Pedestal							• Locking pedestal • Ships set-up
700_-831	15.5	22	28	78	8.6	\$ 380.00	
 File/File Pedestals							• -840 for use with -224 return • Locking pedestal • Ships set-up
700_-832	15.5	22	28	74	8.6	\$ 354.00	
700_-840	15.5	18	28	68	7.3	\$ 354.00	
 Box/File 3/4 Pedestals							• Use the -838 with desk, credenza and return shells except for the -224 return shell • Use the -839 with the -224 return shell • Ships set-up • Locking pedestal
700_-838	15	22.25	20.75	61	6.6	\$ 303.00	
700_-839	15	18.5	20.75	51	5.7	\$ 289.00	
 Personal File Pedestal							• Box / box / personal file / lateral file drawer • Locking drawers • Ships set-up
700_-327	30	22	28	154	16.4	\$ 688.00	
 Personal File Pedestal Top							• -3276 fits on top of the -327 • -817 fits across two -827s to make a storage credenza
700_-3279	30	22	1	18	1.3	\$ 100.00	
 Storage Credenza Top							
700_-817	71	23.75	1			\$ 360.00	



Inigo

LAMINATE COLLECTION

7011 Smoke / 7012 Bourbon Finishes

Modern design for any office.

Contemporize your office with Inigo's minimal, modern design. Available for both open and private office settings, this group features clean lines and a bold, fresh look. With options to suit any size office, Inigo brings a crisp sense of flow to any space.

Details:

- Easily configurable for open office and private office applications
- Desk tops available in white-backed glass, or two laminate finishes: Smoke and Bourbon
- Group also includes a high-top conference table option
- Satin aluminum finish on metal bases
- Overhead storage available in white, or your choice of two laminate finishes: Smoke and Bourbon



FLEXSTEEL®
CONTRACT

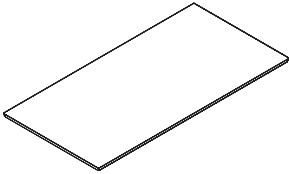
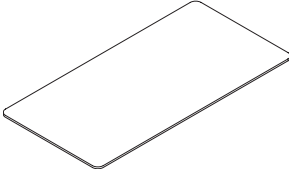
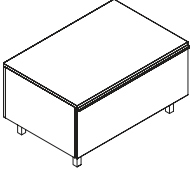
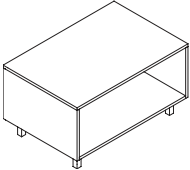
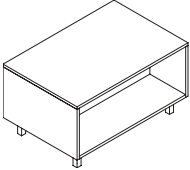
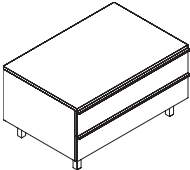
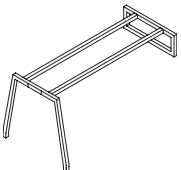
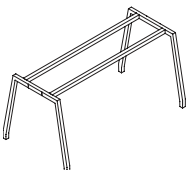
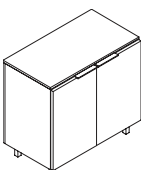

7011 Smoke / 7012 Bourbon Finishes

	Item Description	W"	D"	H"	Weight Lbs.	Cubic Ft.	List Price	Features
	Rectangular Desk Tops							
	701_-4211	72	36		79	6.0	\$ 347.00	
	701_-3211	66	30		60	4.2	\$ 301.00	
	Rectangular Glass Desk Top							
	7013-2211	72	36		163	8.0	\$ 1337.00	• White backed glass top with rounded corners
	Bench Height File Pedestal							
	701_-B816	36	24	20	105	11.3	\$ 571.00	
	Bench Height Open Pedestal							
	701_-B817	36	24	20	64	3.6	\$ 324.00	• Requires assembly
	Bench Height Double Sided Open Pedestal							
	701_-B818	36	24	20	64	2.5	\$ 324.00	
	Bench Height Box/Box Pedestal							
	701_-B819	36	24	20	108	11.3	\$ 695.00	
	Metal Support Base to Bench							
	7019-1163	56	30	28.75	38	6.3	\$ 340.00	• Gray metal • Fits 72" and 66" tops • Requires assembly
	Metal Support Base							
	7019-1164	56	30	28.75	42	6.3	\$ 395.00	• Gray metal • Fits 72" and 66" tops • Requires assembly
	High Credenza White Backed Glass Door Storage Cabinet							
	701_-B820	36	24	34	106	7.3	\$ 775.00	

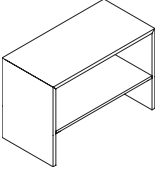
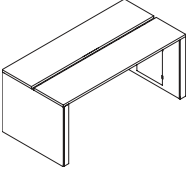
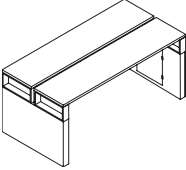
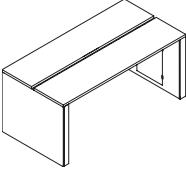
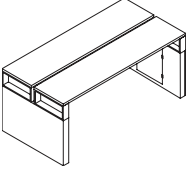
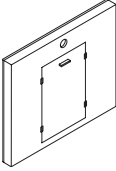
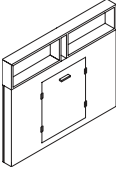
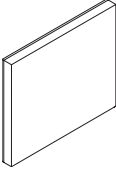
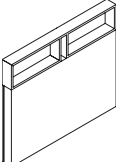

7011 Smoke / 7012 Bourbon Finishes

Item Description	W"	D"	H"	Weight Lbs.	Cubic Ft.	List Price	Features
 <p>Open Overhead 701_-410</p>	36	18	24.5	49	13.6	\$ 330.00	<ul style="list-style-type: none"> • Also available in 7014 White finish
 <p>72" High Top Conference Table 701_-72</p> <p>Consists of:</p> <p>-001 Storage Base</p> <p>-002 Base</p> <p>-005 Table Top with Cable Trough</p>	72	48	42	302	27.2	\$ 1429.00	<ul style="list-style-type: none"> • -001 base has solid end panel with storage for wiring, small splitters and surge protectors • Top ships in two pieces • Accomodates optional 0000-44 Cove Power Center
 <p>72" High Top Conference Table with Metal 701_-72MB</p> <p>Consists of:</p> <p>-003 Metal Box Storage Base</p> <p>-004 Metal Base</p> <p>-005 Table Top with Cable Trough</p>	72	48	42	352	27.2	\$ 2042.00	<ul style="list-style-type: none"> • -003 base has solid end panel with storage for wiring, small splitters and surge protectors • Top ships in two pieces • Accomodates optional 0000-44 Cove Power Center
 <p>96" High Top Conference Table 701_-96</p> <p>Consists of:</p> <p>-001 Storage Base</p> <p>-002 Base</p> <p>-006 Table Top with Cable Trough</p>	96	48	42	349	30.6	\$ 1547.00	<ul style="list-style-type: none"> • -001 base has solid end panel with storage for wiring, small splitters and surge protectors • Top ships in two pieces • Accomodates optional 0000-44 Cove Power Center
 <p>96" High Top Conference Table with Metal 701_-96MB</p> <p>Consists of:</p> <p>-003 Metal Box Storage Base</p> <p>-004 Metal Base</p> <p>-006 Table Top with Cable Trough</p>	96	48	42	399	30.6	\$ 2160.00	<ul style="list-style-type: none"> • -003 base has solid end panel with storage for wiring, small splitters and surge protectors • Top ships in two pieces • Accomodates optional 0000-44 Cove Power Center
 <p>High Top Storage Base 701_-001</p>	48	4.25	40.5	80	9.2	\$ 392.00	<ul style="list-style-type: none"> • Base has a solid end panel with storage for wiring, small splitters and surge protectors
 <p>High Top Storage Base with Metal Boxes 701_-003</p>	48	4.25	40.5	105	9.2	\$ 704.00	<ul style="list-style-type: none"> • Base has a solid end panel with storage for wiring, small splitters and surge protectors
 <p>High Top Bases 701_-002</p>	48	4.25	40.5	80	9.2	\$ 337.00	
 <p>High Top Bases with Metal Boxes 701_-004</p>	48	4.25	40.5	105	9.2	\$ 638.00	



7011 Smoke / 7012 Bourbon Finishes

Item Description	W"	D"	H"	Weight	Cubic	List	Features
Model Number				Lbs.	Ft.	Price	
Table Top with Metal Cable Trough							
701_-005	72	48	1.5	142	8.8	\$ 700.00	<ul style="list-style-type: none"> • Top ships in two pieces • Accomodates optional 0000-44 Cove Power Center
701_-006	96	48	1.5	189	12.2	\$ 818.00	

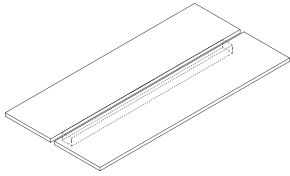



Pimlico

LAMINATE COLLECTION

7020 Mocha Finish / 7027 Walnut Finish

High-contrast materials in a contemporary design.

The sleek and stylized design of the Pimlico collection is enhanced by the satin aluminum finish on the base, top, and hardware.

Details:

- Construction consists of wood and wood products with a Thermally Fused Laminate surface, Cam-lock fasteners, screws and cleats for reinforcement and stability
- All top surfaces are 1.125" thick with the TFL surface, color matched PVC edges and wood substraight and are separated from the chassis with a satin aluminum finish painted reveal
- Three modesty panel options available on desking casegoods
- All drawers feature a 4-sided melamine on MDF construction with pinned and glued joints and full extension, metal ball bearing slides
- Locking drawers are all keyed the same. If you need specific items keyed differently, please contact your customer service representative
- Pedestals lock via knee-hole located lock
- Box drawers rated for 75 lbs
- File drawers rated for 150 lbs
- File drawers equipped with metal rods for letter or legal sized hanging files
- Adjustable floor levelers
- Cable accessible
- Available set-up or flat pack

* Items within this collection marked with an asterisk are GSA items.



FLEXSTEEL®
CONTRACT

DMI COLLECTION



7020 Mocha Finish / 7027 Walnut Finish

DMI COLLECTION

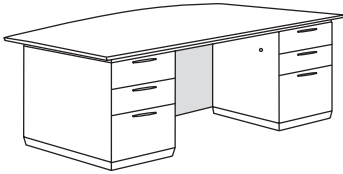
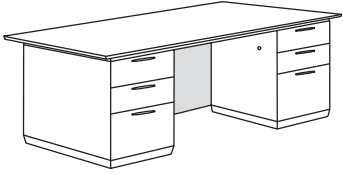
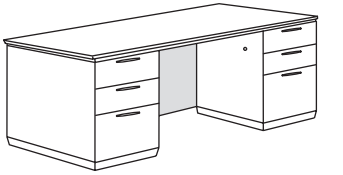

Item Description	W"	D"	H"	Weight Lbs.	Cubic Ft.	List Price	Features
 Executive Bow Front Desk* 702_-37*	72	42	30	380	65.3	\$ 2337.00	<ul style="list-style-type: none"> • Locking box / box / file drawer per pedestal • Pencil tray in top box drawers • Removable divider in bottom box drawers • Grommet in corners of top
Executive Bow Front Desk (Flat Packed) 702_-37FP	72	42	30	392	42.5	\$ 1933.00	
Consists of:							
-371 Bow Desk Top, Modesty				128	8.7	\$ 487.00	
-362 Right B/B/F Pedestal				132	16.9	\$ 723.00	
-363 Left B/B/F Pedestal				132	16.9	\$ 723.00	
Executive Bow Front Desk with White Glass Modesty Panel* 702_-37WG*	72	42	30	380	65.3	\$ 2454.00	
Executive Bow Front Desk with White Glass Modesty Panel (Flat Packed) 702_-37WGFP	72	42	30	392	43.7	\$ 1967.00	
Consists of:							
-371WG Bow Desk Top, Modesty				128	9.9	\$ 521.00	
-362 Right B/B/F Pedestal				132	16.9	\$ 723.00	
-363 Left B/B/F Pedestal				132	16.9	\$ 723.00	
Executive Bow Front Desk with Laminate Modesty Panel* 702_-37L*	72	42	30	380	65.3	\$ 2408.00	
Executive Bow Front Desk with Laminate Modesty Panel (Flat Packed) 702_-37LFP	72	42	30	392	42.5	\$ 1956.00	
Consists of:							
-371L Bow Desk Top, Modesty				128	8.7	\$ 510.00	
-362 Right B/B/F Pedestal				132	16.9	\$ 723.00	
-363 Left B/B/F Pedestal				132	16.9	\$ 723.00	
 Executive Desk* 702_-36*	72	36	30	371	55.1	\$ 2138.00	<ul style="list-style-type: none"> • Locking box / box / file drawer per pedestal • Pencil tray in top box drawers • Removable divider in bottom box drawers • Grommet in corners of top
Executive Desk (Flat Packed) 702_-36FP	72	36	30	383	41.3	\$ 1864.00	
Consists of:							
-361 Desk Top, Modesty				119	7.5	\$ 418.00	
-362 Right B/B/F Pedestal				132	16.9	\$ 723.00	
-363 Left B/B/F Pedestal				132	16.9	\$ 723.00	
Executive Desk with White Glass Modesty Panel* 702_-36WG*	72	36	30	371	55.1	\$ 2244.00	
Executive Desk with White Glass Modesty Panel (Flat Packed) 702_-36WGFP	72	36	30	383	41.3	\$ 1894.00	
Consists of:							
-361WG 6Desk Top, Modesty				119	7.5	\$ 448.00	
-362 Right B/B/F Pedestal				132	16.9	\$ 723.00	
-363 Left B/B/F Pedestal				132	16.9	\$ 723.00	
Executive Desk with Laminate Modesty Panel* 702_-36L*	72	36	30	371	55.1	\$ 2202.00	
Executive Desk with Laminate Modesty Panel (Flat Packed) 702_-36LFP	72	36	30	383	41.3	\$ 1871.00	
Consists of:							
-361L Desk Top, Modesty				119	7.5	\$ 425.00	
-362 Right B/B/F Pedestal				132	16.9	\$ 723.00	
-363 Left B/B/F Pedestal				132	16.9	\$ 723.00	
 Executive Desk* 702_-30*	66	30	30	324	43.0	\$ 1917.00	<ul style="list-style-type: none"> • Locking box / box / file drawer per pedestal • Pencil tray in top box drawers • Removable divider in bottom box drawers • Grommet in corners of top
Executive Desk (Flat Packed) 702_-30FP	66	30	30	337	31.9	\$ 1660.00	
Consists of:							
-301 Desk Top, Modesty				99	7.5	\$ 350.00	
-302 Right B/B/F Pedestal				119	13.0	\$ 655.00	
-303 Left B/B/F Pedestal				119	13.0	\$ 655.00	
Executive Desk with White Glass Modesty Panel* 702_-30WG*	66	30	30	324	43.0	\$ 2014.00	
Executive Desk with White Glass Modesty Panel (Flat Packed) 702_-30WGFP	66	30	30	337	31.9	\$ 1679.00	
Consists of:							
-301WG Desk Top, Modesty				99	7.5	\$ 369.00	
-302 Right B/B/F Pedestal				119	13.0	\$ 655.00	
-303 Left B/B/F Pedestal				119	13.0	\$ 655.00	
Executive Desk with Laminate Modesty Panel* 702_-30L*	66	30	30	324	43.0	\$ 1975.00	
Executive Desk with Laminate Modesty Panel (Flat Packed) 702_-30LFP	66	30	30	337	31.9	\$ 1673.00	
Consists of:							
-301L Desk Top, Modesty				99	7.5	\$ 363.00	
-302 Right B/B/F Pedestal				119	13.0	\$ 655.00	
-303 Left B/B/F Pedestal				119	13.0	\$ 655.00	

* Items within this collection marked with an asterisk are GSA items.



DMI COLLECTION

7020 Mocha Finish / 7027 Walnut Finish

	Item Description	W"	D"	H"	Weight	Cubic	List	Features
	Model Number				Lbs.	Ft.	Price	
	Kneehole Credenza*							
	702_-21*	72	24	30	287	40.2	\$ 1887.00	<ul style="list-style-type: none"> • Locking box / box / file drawer per pedestal • Pencil tray in top box drawers • Removable divider in bottom box drawers • Cable accessible
	Kneehole Credenza (Flat Packed)							
	702_-21FP	72	24	30	291	29.8	\$ 1543.00	
	Consists of:							
	-211 Credenza Top, Modesty				93	5.6	\$ 373.00	
	-212 Right B/B/F Pedestal				99	12.1	\$ 585.00	
	-213 Left B/B/F Pedestal				99	12.1	\$ 585.00	
	Kneehole Credenza*							
	702_-19*	66	24	30	283	35.9	\$ 1813.00	
	Kneehole Credenza (Flat Packed)							
	702_-19FP	66	24	30	288	29.4	\$ 1420.00	
	Consists of:							
	-191 Credenza Top, Modesty				90	5.2	\$ 250.00	
	-212 Right B/B/F Pedestal				99	12.1	\$ 585.00	
	-213 Left B/B/F Pedestal				99	12.1	\$ 585.00	
	Kneehole Credenza*							
	702_-215*	70	24	30	300	40.2	\$ 1857.00	<ul style="list-style-type: none"> • Locking box / box / file drawer per pedestal • Pencil tray in top box drawers • Removable divider in bottom box drawers • Cable accessible
	Kneehole Credenza (Flat Packed)							
	702_-215FP	70	24	30	299	29.6	\$ 1498.00	
	Consists of:							
	-2151 Credenza Top, Modesty				101	5.4	\$ 328.00	
	-212 Right B/B/F Pedestal				99	12.1	\$ 585.00	
	-213 Left B/B/F Pedestal				99	12.1	\$ 585.00	
	Storage Credenza							
	702_-20	72	24	30	354	41.8	\$ 2183.00	<ul style="list-style-type: none"> • Box / box / file drawer per pedestal • Pencil tray in top box drawers • Removable divider in bottom box drawers • Center two-door cabinet with adjustable shelf • Locking peds via locks accessible through cabinet



7020 Mocha Finish / 7027 Walnut Finish

DMI COLLECTION

Item Description	Weight	Cubic	List	Features
Model Number	W" D" H"	Lbs. Ft.	Price	
Right Executive Bow Front L Desk*				<ul style="list-style-type: none"> • Locking box / box / file drawer per pedestal • Pencil tray in top box drawers • Removable divider in bottom box drawers • Grommet in corners of top
702_-47B*	72 90 30	507 91.7	\$ 3323.00	
Consists of:				
-570B Left Single Ped Desk	72 42 30	325 65.3	\$ 2064.00	
-579 Right Single Ped Return	48 24 30	182 26.4	\$ 1259.00	
Right Executive Bow Front L Desk (Flat Packed)				
702_-47BFP	72 90 30	496 47.3	\$ 2549.00	
Consists of:				
-371 Bow Desk Top, Modesty		128 8.7	\$ 487.00	
-363 Left B/B/F Pedestal		132 16.9	\$ 723.00	
-5702 Right Desk Support Ped		58 5.3	\$ 426.00	
-5791 Right Return Top, Modesty		79 4.3	\$ 328.00	
-212 Right B/B/F Pedestal		99 12.1	\$ 585.00	
Right Executive Bow Front L Desk with White Glass Modesty*				
702_-47BWG*	72 90 30	507 91.7	\$ 3426.00	
Consists of:				
-570BWG Left Single Ped Desk	72 42 30	325 65.3	\$ 2167.00	
-579 Right Single Ped Return	48 24 30	182 26.4	\$ 1259.00	
Right Executive Bow Front L Desk with White Glass Modesty (Flat Packed)				
702_-47BWGFP	72 90 30	496 48.5	\$ 2583.00	
Consists of:				
-371WG Bow Desk Top, Modesty		128 9.9	\$ 521.00	
-363 Left B/B/F Pedestal		132 16.9	\$ 723.00	
-5702 Right Desk Support Ped		58 5.3	\$ 426.00	
-5791 Right Return Top, Modesty		79 4.3	\$ 328.00	
-212 Right B/B/F Pedestal		99 12.1	\$ 585.00	
Right Executive Bow Front L Desk with Laminate Modesty*				
702_-47BL*	72 90 30	507 91.7	\$ 3386.00	
Consists of:				
-570BL Left Single Ped Desk	72 42 30	325 65.3	\$ 2127.00	
-579 Right Single Ped Return	48 24 30	182 26.4	\$ 1259.00	
Right Executive Bow Front L Desk with Laminate Modesty (Flat Packed)				
702_-47BLFP	72 90 30	496 48.5	\$ 2572.00	
Consists of:				
-371L Bow Desk Top, Modesty		128 9.9	\$ 510.00	
-363 Left B/B/F Pedestal		132 16.9	\$ 723.00	
-5702 Right Desk Support Ped		58 5.3	\$ 426.00	
-5791 Right Return Top, Modesty		79 4.3	\$ 328.00	
-212 Right B/B/F Pedestal		99 12.1	\$ 585.00	
Left Executive Bow Front L Desk*				
702_-48B*	72 90 30	507 91.7	\$ 3323.00	
Consists of:				
-580B Right Single Ped Desk	72 42 30	325 65.3	\$ 2064.00	
-589 Left Single Ped Return	48 24 30	182 26.4	\$ 1259.00	
Left Executive Bow Front L Desk (Flat Packed)				
702_-48BFP	72 90 30	496 47.3	\$ 2549.00	
Consists of:				
-371 Bow Desk Top, Modesty		128 8.7	\$ 487.00	
-362 Right B/B/F Pedestal		132 16.9	\$ 723.00	
-5802 Left Desk Support Ped		58 5.3	\$ 426.00	
-5891 Left Return Top, Modesty		79 4.3	\$ 328.00	
-213 Left B/B/F Pedestal		99 12.1	\$ 585.00	
Left Executive Bow Front L Desk with White Glass Modesty*				
702_-48BWG*	72 90 30	507 91.7	\$ 3426.00	
Consists of:				
-580BWG Right Single Ped Desk	72 42 30	325 65.3	\$ 2167.00	
-589 Left Single Ped Return	48 24 30	182 26.4	\$ 1259.00	
Left Executive Bow Front L Desk with White Glass Modesty (Flat Packed)				
702_-48BWGFP	72 90 30	496 48.5	\$ 2583.00	
Consists of:				
-371WG Bow Desk Top, Modesty		128 9.9	\$ 521.00	
-362 Right B/B/F Pedestal		132 16.9	\$ 723.00	
-5802 Left Desk Support Ped		58 5.3	\$ 426.00	
-5891 Left Return Top, Modesty		79 4.3	\$ 328.00	
-213 Left B/B/F Pedestal		99 12.1	\$ 585.00	
Left Executive Bow Front L Desk with Laminate Modesty*				
702_-48BL*	72 90 30	507 91.7	\$ 3386.00	
Consists of:				
-580BL Right Single Ped Desk	72 42 30	325 65.3	\$ 2127.00	
-589 Left Single Ped Return	48 24 30	182 26.4	\$ 1259.00	
Left Executive Bow Front L Desk with Laminate Modesty (Flat Packed)				
702_-48BLFP	72 90 30	496 48.5	\$ 272.00	
Consists of:				
-371L Bow Desk Top, Modesty		128 9.9	\$ 510.00	
-362 Right B/B/F Pedestal		132 16.9	\$ 723.00	
-5802 Left Desk Support Ped		58 5.3	\$ 426.00	
-5891 Left Return Top, Modesty		79 4.3	\$ 328.00	
-213 Left B/B/F Pedestal		99 12.1	\$ 585.00	

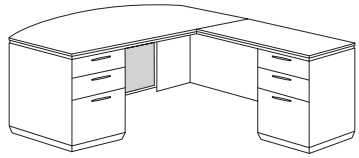

Right

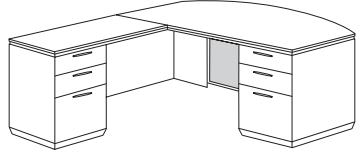

Left

* Items within this collection marked with an asterisk are GSA items.

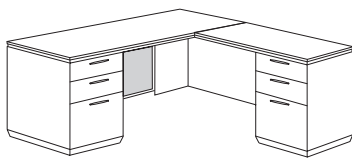

Right

Item Description	W"	D"	H"	Weight	Cubic	List	Features
Model Number				Lbs.	Ft.	Price	
Right Executive L Desk*							
702_-47*	72	84	30	478	81.5	\$ 3257.00	<ul style="list-style-type: none"> • Locking box / box / file drawer per pedestal • Pencil tray in top box drawers • Removable divider in bottom box drawers • Grommet in corners of top
Consists of:							
-570 Left Single Ped Desk	72	36	30	296	55.1	\$ 1998.00	
-579 Right Single Ped Return	48	24	30	182	26.4	\$ 1259.00	
Right Executive L Desk (Flat Packed)							
702_-47FP	72	84	30	487	46.1	\$ 2480.00	
Consists of:							
-361 Desk Top, Modesty				119	7.5	\$ 418.00	
-363 Left B/B/F Pedestal				132	16.9	\$ 723.00	
-5702 Right Desk Support Ped				58	5.3	\$ 426.00	
-5791 Right Return Top, Modesty				79	4.3	\$ 328.00	
-212 Right B/B/F Pedestal				99	12.1	\$ 585.00	
Right Executive L Desk with White Glass Modesty*							
702_-47WG*	72	84	30	478	81.5	\$ 3357.00	
Consists of:							
-570WG Left Single Ped Desk	72	36	30	296	55.1	\$ 2098.00	
-579 Right Single Ped Return	48	24	30	182	26.4	\$ 1259.00	
Right Executive L Desk with White Glass Modesty (Flat Packed)							
702_-47WGFP	72	84	30	496	48.5	\$ 2510.00	
Consists of:							
-361WG Desk Top, Modesty				128	9.9	\$ 448.00	
-363 Left B/B/F Pedestal				132	16.9	\$ 723.00	
-5702 Right Desk Support Ped				58	5.3	\$ 426.00	
-5791 Right Return Top, Modesty				79	4.3	\$ 328.00	
-212 Right B/B/F Pedestal				99	12.1	\$ 585.00	
Right Executive L Desk with Laminate Modesty*							
702_-47L*	72	84	30	478	81.5	\$ 3318.00	
Consists of:							
-570L Left Single Ped Desk	72	36	30	296	55.1	\$ 2059.00	
-579 Right Single Ped Return	48	24	30	182	26.4	\$ 1259.00	
Right Executive L Desk with Laminate Modesty (Flat Packed)							
702_-47LFP	72	84	30	496	48.5	\$ 2487.00	
Consists of:							
-361L Desk Top, Modesty				128	9.9	\$ 425.00	
-363 Left B/B/F Pedestal				132	16.9	\$ 723.00	
-5702 Right Desk Support Ped				58	5.3	\$ 426.00	
-5791 Right Return Top, Modesty				79	4.3	\$ 328.00	
-212 Right B/B/F Pedestal				99	12.1	\$ 585.00	
Left Executive L Desk*							
702_-48*	72	84	30	478	81.5	\$ 3257.00	
Consists of:							
-580 Right Single Ped Desk	72	36	30	296	55.1	\$ 1998.00	
-589 Left Single Ped Return	48	24	30	182	26.4	\$ 1259.00	
Left Executive L Desk (Flat Packed)							
702_-48FP	72	84	30	487	46.1	\$ 2480.00	
Consists of:							
-361 Desk Top, Modesty				119	7.5	\$ 418.00	
-362 Right B/B/F Pedestal				132	16.9	\$ 723.00	
-5802 Left Desk Support Ped				58	5.3	\$ 426.00	
-5891 Left Return Top, Modesty				79	4.3	\$ 328.00	
-213 Left B/B/F Pedestal				99	12.1	\$ 585.00	
Left Executive L Desk with White Glass Modesty*							
702_-48WG*	72	84	30	478	81.5	\$ 3357.00	
Consists of:							
-580WG Right Single Ped Desk	72	36	30	296	55.1	\$ 2098.00	
-589 Left Single Ped Return	48	24	30	182	26.4	\$ 1259.00	
Left Executive L Desk with White Glass Modesty (Flat Packed)							
702_-48WGFP	72	84	30	496	48.5	\$ 2510.00	
Consists of:							
-361WG Desk Top, Modesty				128	9.9	\$ 448.00	
-362 Right B/B/F Pedestal				132	16.9	\$ 723.00	
-5802 Left Desk Support Ped				58	5.3	\$ 426.00	
-5891 Left Return Top, Modesty				79	4.3	\$ 328.00	
-213 Left B/B/F Pedestal				99	12.1	\$ 585.00	
Left Executive L Desk with Laminate Modesty*							
702_-48L*	72	84	30	478	81.5	\$ 3318.00	
Consists of:							
-580L Right Single Ped Desk	72	36	30	296	55.1	\$ 2059.00	
-589 Left Single Ped Return	48	24	30	182	26.4	\$ 1259.00	
Left Executive L Desk with Laminate Modesty (Flat Packed)							
702_-48LFP	72	84	30	496	48.5	\$ 2487.00	
Consists of:							
-361L Desk Top, Modesty				128	9.9	\$ 425.00	
-362 Right B/B/F Pedestal				132	16.9	\$ 723.00	
-5802 Left Desk Support Ped				58	5.3	\$ 426.00	
-5891 Left Return Top, Modesty				79	4.3	\$ 328.00	
-213 Left B/B/F Pedestal				99	12.1	\$ 585.00	

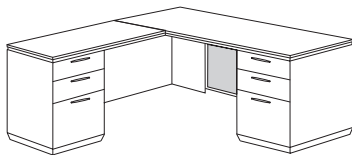

Left

* Items within this collection marked with an asterisk are GSA items.



7020 Mocha Finish / 7027 Walnut Finish

DMI COLLECTION

Item Description	W"	D"	H"	Weight Lbs.	Cubic Ft.	List Price	Features
Right Executive L Desk*							
702_-27*	66	78	30	432	69.4	\$ 3065.00	<ul style="list-style-type: none"> • Locking box / box / file drawer per pedestal • Pencil tray in top box drawers • Removable divider in bottom box drawers • Grommet in corners of top
Consists of:							
-370 Left Single Ped Desk	66	30	30	250	43.0	\$ 1806.00	
-579 Right Single Ped Return	48	24	30	182	26.4	\$ 1259.00	
Right Executive L Desk (Flat Packed)							
702_-27FP	66	78	30	445	37.3	\$ 2314.00	
Consists of:							
-301 Desk Top, Modesty				99	5.9	\$ 350.00	
-303 Left B/B/F Pedestal				119	13.0	\$ 655.00	
-2702 Right Desk Support Ped				49	3.0	\$ 396.00	
-5791 Right Return Top, Modesty				79	4.3	\$ 328.00	
-212 Right B/B/F Pedestal				99	12.1	\$ 585.00	
Right Executive L Desk with White Glass Modesty*							
702_-27WG*	66	78	30	432	69.4	\$ 3155.00	
Consists of:							
-370WG Left Single Ped Desk	66	30	30	250	43.0	\$ 1896.00	
-579 Right Single Ped Return	48	24	30	182	26.4	\$ 1259.00	
Right Executive L Desk with White Glass Modesty (Flat Packed)							
702_-27WGFP	66	78	30	445	39.2	\$ 2333.00	
Consists of:							
-301WG Desk Top, Modesty				99	6.8	\$ 369.00	
-303 Left B/B/F Pedestal				119	13.0	\$ 655.00	
-2702 Right Desk Support Ped				49	3.0	\$ 396.00	
-5791 Right Return Top, Modesty				79	4.3	\$ 328.00	
-212 Right B/B/F Pedestal				99	12.1	\$ 585.00	
Right Executive L Desk with Laminate Modesty*							
702_-27L*	66	78	30	432	69.4	\$ 3119.00	
Consists of:							
-370L Left Single Ped Desk	66	30	30	250	43.0	\$ 1860.00	
-579 Right Single Ped Return	48	24	30	182	26.4	\$ 1259.00	
Right Executive L Desk with Laminate Modesty (Flat Packed)							
702_-27LFP	66	78	30	445	39.2	\$ 2327.00	
Consists of:							
-301L Desk Top, Modesty				99	6.8	\$ 363.00	
-303 Left B/B/F Pedestal				119	13.0	\$ 655.00	
-2702 Right Desk Support Ped				49	3.0	\$ 396.00	
-5791 Right Return Top, Modesty				79	4.3	\$ 328.00	
-212 Right B/B/F Pedestal				99	12.1	\$ 585.00	
Left Executive L Desk*							
702_-28*	66	78	30	432	69.4	\$ 3065.00	
Consists of:							
-380 Right Single Ped Desk	66	30	30	250	43.0	\$ 1806.00	
-589 Left Single Ped Return	48	24	30	182	26.4	\$ 1259.00	
Left Executive L Desk (Flat Packed)							
702_-28FP	66	78	30	445	37.3	\$ 2314.00	
Consists of:							
-301 Desk Top, Modesty				99	5.9	\$ 350.00	
-302 Right B/B/F Pedestal				119	13.0	\$ 655.00	
-2802 Right Desk Support Ped				49	3.0	\$ 396.00	
-5891 Left Return Top, Modesty				79	4.3	\$ 328.00	
-213 Left B/B/F Pedestal				99	12.1	\$ 585.00	
Left Executive L Desk with White Glass Modesty*							
702_-28WG*	66	78	30	432	69.4	\$ 3155.00	
Consists of:							
-380WG Right Single Ped Desk	66	30	30	250	43.0	\$ 1896.00	
-589 Left Single Ped Return	48	24	30	182	26.4	\$ 1259.00	
Left Executive L Desk with White Glass Modesty (Flat Packed)							
702_-28WGFP	66	78	30	445	39.2	\$ 2333.00	
Consists of:							
-301WG Desk Top, Modesty				99	6.8	\$ 369.00	
-302 Right B/B/F Pedestal				119	13.0	\$ 655.00	
-2802 Left Desk Support Ped				49	3.0	\$ 396.00	
-5891 Left Return Top, Modesty				79	4.3	\$ 328.00	
-213 Left B/B/F Pedestal				99	12.1	\$ 585.00	
Left Executive L Desk with Laminate Modesty*							
702_-28L*	66	78	30	432	69.4	\$ 3119.00	
Consists of:							
-380L Right Single Ped Desk	66	30	30	250	43.0	\$ 1860.00	
-589 Left Single Ped Return	48	24	30	182	26.4	\$ 1259.00	
Left Executive L Desk with Laminate Modesty (Flat Packed)							
702_-28LFP	66	78	30	445	39.2	\$ 2327.00	
Consists of:							
-301L Desk Top, Modesty				99	6.8	\$ 363.00	
-302 Right B/B/F Pedestal				119	13.0	\$ 655.00	
-2802 Left Desk Support Ped				49	3.0	\$ 396.00	
-5891 Left Return Top, Modesty				79	4.3	\$ 328.00	
-213 Left B/B/F Pedestal				99	12.1	\$ 585.00	

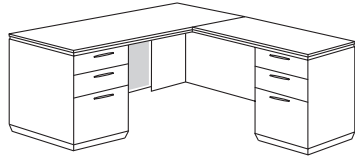

Right

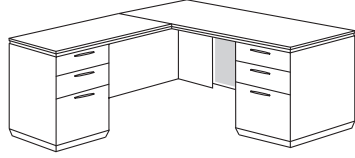

Left

* Items within this collection marked with an asterisk are GSA items.



DMI COLLECTION

7020 Mocha Finish / 7027 Walnut Finish

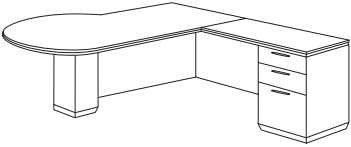
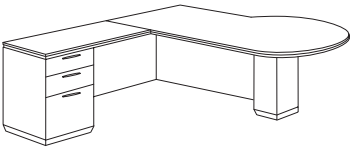
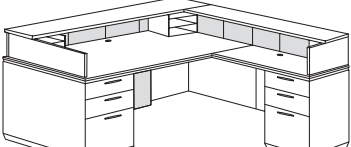
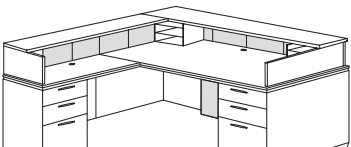
	Item Description	W"	D"	H"	Weight	Cubic	List	Features
	Model Number				Lbs.	Ft.	Price	
	Right Peninsula L Desk							
	702_-45	72	90	30	418	41.6	\$ 2184.00	<ul style="list-style-type: none"> • Locking box / box / file drawer in the return pedestal • Pencil tray in the top box drawer • Removable divider in bottom box drawer • -520/-530 require assembly • Grommet in return top
	Consists of:							
	-520 Left Peninsula Top, Panels	72	42	30	190	11.0	\$ 666.00	
-113 Peninsula Desk Post				46	4.2	\$ 259.00		
-579 Right Single Ped Return	48	24	30	182	26.4	\$ 1259.00		
Right	Right Peninsula L Desk (Flat Packed)							
	702_-45FP	72	90	30	414	31.6	\$ 1838.00	
	Consists of:							
	-520 Left Peninsula Top, Panels	72	42	30	190	11.0	\$ 666.00	
-113 Peninsula Desk Post				46	4.2	\$ 259.00		
-5791 Right Return Top, Modesty				79	4.3	\$ 328.00		
-212 Right B/B/F Pedestal				99	12.1	\$ 585.00		
	Left Peninsula L Desk							
	702_-46	72	90	30	418	41.6	\$ 2184.00	
	Consists of:							
	-530 Right Peninsula Top, Panels	72	42	30	190	11.0	\$ 666.00	
-113 Peninsula Desk Post				46	4.2	\$ 259.00		
-589 Left Single Ped Return	48	24	30	182	26.4	\$ 1259.00		
Left	Left Peninsula L Desk (Flat Packed)							
	702_-46FP	72	90	30	414	31.6	\$ 1838.00	
	Consists of:							
	-530 Right Peninsula Top, Panels	72	42	30	190	11.0	\$ 666.00	
-113 Peninsula Desk Post				46	4.2	\$ 259.00		
-5891 Left Return Top, Modesty				79	4.3	\$ 328.00		
-213 Left B/B/F Pedestal				99	12.1	\$ 585.00		
	Right Reception L Desk (Flat Packed)							<ul style="list-style-type: none"> • Locking box / box / file drawer per pedestal • Pencil tray in top box drawers • Removable divider in bottom box drawers • Organizers with desk hutch • Desk with riser: 72" x 36" x 42" • Return with riser: 48" x 24" x 42" • Grommets in tops
	702_-66FP	72	84	42	489	56.3	\$ 3511.00	
	Consists of:							
	-681 Left Desk Top, Modesty, Hutch				120	11.9	\$ 1210.00	
-363 Left B/B/F Pedestal				132	16.9	\$ 723.00		
-5702 Right Desk Support Ped				58	5.3	\$ 426.00		
-1791 Right Return, Modesty, Hutch				80	10.1	\$ 567.00		
-212 Right B/B/F Pedestal				99	12.1	\$ 585.00		
Right	Right Reception L Desk with White Glass Modesty (Flat Packed)							
	702_-66WGFP	72	84	42	489	56.3	\$ 3562.00	
	Consists of:							
	-681WG Left Desk Top, Modesty, Hutch				120	11.9	\$ 1210.00	
-363 Left B/B/F Pedestal				132	16.9	\$ 723.00		
-5702 Right Desk Support Ped				58	5.3	\$ 426.00		
-1791WG Right Return, Modesty, Hutch				80	10.1	\$ 618.00		
-212 Right B/B/F Pedestal				99	12.1	\$ 585.00		
	Left Reception L Desk (Flat Packed)							
	702_-67FP	72	84	42	489	56.3	\$ 3511.00	
	Consists of:							
	-691 Right Desk Top, Modesty, Hutch				120	11.9	\$ 1210.00	
-362 Right B/B/F Pedestal				132	16.9	\$ 723.00		
-5802 Left Desk Support Ped				58	5.3	\$ 426.00		
-1891 Left Return, Modesty, Hutch				80	10.1	\$ 567.00		
-213 Left B/B/F Pedestal				99	12.1	\$ 585.00		
Left	Left Reception L Desk with White Glass Modesty (Flat Packed)							
	702_-67WGFP	72	84	42	489	56.3	\$ 3562.00	
	Consists of:							
	-691WG Right Desk Top, Modesty, Hutch				120	11.9	\$ 1210.00	
-362 Right B/B/F Pedestal				132	16.9	\$ 723.00		
-5802 Left Desk Support Ped				58	5.3	\$ 426.00		
-1891WG Left Return, Modesty, Hutch				80	10.1	\$ 618.00		
-213 Left B/B/F Pedestal				99	12.1	\$ 585.00		

* Items within this collection marked with an asterisk are GSA items.



7020 Mocha Finish / 7027 Walnut Finish

DMI COLLECTION

Item Description	Weight	Cubic	List	
Model Number	W" D" H"	Lbs. Ft.	Price	Features
Right Executive Bow Front U Desk*				
702_-57B*	72 114 30	632	112.1	\$ 3980.00
Consists of:				
-570B Left Single Ped Desk	72 42 30	325	65.3	\$ 2064.00
-571 Right Single Ped Credenza	72 24 30	228	40.2	\$ 1553.00
-59 U Bridge	48 24 30	79	6.6	\$ 363.00
				<ul style="list-style-type: none"> • Locking box / box / file drawer per pedestal • Pencil tray in top box drawers • Removable divider in bottom box drawers • Grommets in corners of desk top • Grommets in credenza and bridge modesty panels
Right Executive Bow Front U Desk (Flat Packed)				
702_-57BFP	72 114 30	705	57.3	\$ 3185.00
Consists of:				
-371 Bow Desk Top, Modesty		128	8.7	\$ 487.00
-363 Left B/B/F Pedestal		132	16.9	\$ 723.00
-5702 Right Desk Support Ped		58	5.3	\$ 426.00
-211 Credenza Top, Modesty		110	5.6	\$ 373.00
-212 Right B/B/F Pedestal		99	12.1	\$ 585.00
-2101 Left Credenza Support Pedestal		99	2.1	\$ 228.00
-59 U Bridge		79	6.6	\$ 363.00
Right Executive Bow Front U Desk with White Glass Modesty*				
702_-57BWG*	72 114 30	632	112.1	\$ 4083.00
Consists of:				
-570BWG Left Single Ped Desk	72 42 30	325	65.3	\$ 2167.00
-571 Right Single Ped Credenza	72 24 30	228	40.2	\$ 1553.00
-59 U Bridge	48 24 30	79	6.6	\$ 363.00
Right Executive Bow Front U Desk with White Glass Modesty (Flat Packed)				
702_-57BWGFP	72 114 30	705	58.5	\$ 3219.00
Consists of:				
-371WG Bow Desk Top, Modesty		128	9.9	\$ 521.00
-363 Left B/B/F Pedestal		132	16.9	\$ 723.00
-5702 Right Desk Support Ped		58	5.3	\$ 426.00
-211 Credenza Top, Modesty		110	5.6	\$ 373.00
-212 Right B/B/F Pedestal		99	12.1	\$ 585.00
-2101 Left Credenza Support Pedestal		99	2.1	\$ 228.00
-59 U Bridge		79	6.6	\$ 363.00
Right Executive Bow Front U Desk with Laminate Modesty*				
702_-57BL*	72 114 30	632	112.1	\$ 4043.00
Consists of:				
-570BL Left Single Ped Desk	72 42 30	325	65.3	\$ 2127.00
-571 Right Single Ped Credenza	72 24 30	228	40.2	\$ 1553.00
-59 U Bridge	48 24 30	79	6.6	\$ 363.00
Right Executive Bow Front U Desk with Laminate Modesty (Flat Packed)				
702_-57BLFP	72 114 30	705	58.5	\$ 3208.00
Consists of:				
-371L Bow Desk Top, Modesty		128	9.9	\$ 510.00
-363 Left B/B/F Pedestal		132	16.9	\$ 723.00
-5702 Right Desk Support Ped		58	5.3	\$ 426.00
-211 Credenza Top, Modesty		110	5.6	\$ 373.00
-212 Right B/B/F Pedestal		99	12.1	\$ 585.00
-2101 Left Credenza Support Pedestal		99	2.1	\$ 228.00
-59 U Bridge		79	6.6	\$ 363.00

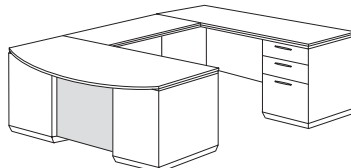

* Items within this collection marked with an asterisk are GSA items.

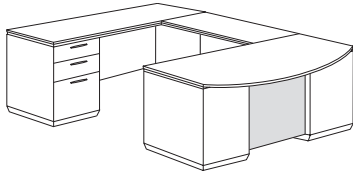

Item Description	Weight	Cubic	List	Features				
Model Number	Lbs.	Ft.	Price					
Left Executive Bow Front U Desk*								
702_-58B*	72	114	30	632	112.1	\$	3980.00	<ul style="list-style-type: none"> • Locking box / box / file drawer per pedestal • Pencil tray in top box drawers • Removable divider in bottom box drawers • Grommets in corners of desk top • Grommets in credenza and bridge modesty panels
Consists of:								
-580B Right Single Ped Desk	72	42	30	325	65.3	\$	2064.00	
-581 Left Single Ped Credenza	72	24	30	228	40.2	\$	1553.00	
-59 U Bridge	48	24	30	79	6.6	\$	363.00	
Left Executive Bow Front U Desk (Flat Packed)								
702_-58BFP	72	114	30	705	57.3	\$	3185.00	
Consists of:								
-371 Bow Desk Top, Modesty				128	8.7	\$	487.00	
-362 Right B/B/F Pedestal				132	16.9	\$	723.00	
-5802 Left Desk Support Ped				58	5.3	\$	426.00	
-211 Credenza Top, Modesty				110	5.6	\$	373.00	
-213 Left B/B/F Pedestal				99	12.1	\$	585.00	
-2102 Right Credenza Support Pedestal				99	2.1	\$	228.00	
-59 U Bridge				79	6.6	\$	363.00	
Left Executive Bow Front U Desk with White Glass Modesty*								
702_-58BWG*	72	114	30	632	112.1	\$	4083.00	
Consists of:								
-580BWG Right Single Ped Desk	72	42	30	325	65.3	\$	2167.00	
-581 Left Single Ped Credenza	72	24	30	228	40.2	\$	1553.00	
-59 U Bridge	48	24	30	79	6.6	\$	363.00	
Left Executive Bow Front U Desk with White Glass Modesty (Flat Packed)								
702_-58BWGFP	72	114	30	705	58.5	\$	3219.00	
Consists of:								
-371WG Bow Desk Top, Modesty				128	9.9	\$	521.00	
-362 Right B/B/F Pedestal				132	16.9	\$	723.00	
-5802 Left Desk Support Ped				58	5.3	\$	426.00	
-211 Credenza Top, Modesty				110	5.6	\$	373.00	
-213 Left B/B/F Pedestal				99	12.1	\$	585.00	
-2102 Right Credenza Support Pedestal				99	2.1	\$	228.00	
-59 U Bridge				79	6.6	\$	363.00	
Left Executive Bow Front U Desk with Laminate Modesty*								
702_-58BL*	72	114	30	632	112.1	\$	4043.00	
Consists of:								
-580BL Right Single Ped Desk	72	42	30	325	65.3	\$	2127.00	
-581 Left Single Ped Credenza	72	24	30	228	40.2	\$	1553.00	
-59 U Bridge	48	24	30	79	6.6	\$	363.00	
Left Executive Bow Front U Desk with Laminate Modesty (Flat Packed)								
702_-58BLFP	72	114	30	705	58.5	\$	3208.00	
Consists of:								
-371L Bow Desk Top, Modesty				128	9.9	\$	510.00	
-362 Right B/B/F Pedestal				132	16.9	\$	723.00	
-5802 Left Desk Support Ped				58	5.3	\$	426.00	
-211 Credenza Top, Modesty				110	5.6	\$	373.00	
-213 Left B/B/F Pedestal				99	12.1	\$	585.00	
-2102 Right Credenza Support Pedestal				99	2.1	\$	228.00	
-59 U Bridge				79	6.6	\$	363.00	

* Items within this collection marked with an asterisk are GSA items.

Pimlico LAMINATE COLLECTION



FLEXSTEEL®
CONTRACT

7020 Mocha Finish / 7027 Walnut Finish

DMI COLLECTION

Item Description	Weight	Cubic	List				
Model Number	W"	D"	H"	Lbs.	Ft.	Price	Features
Right Executive U Desk*							
702_-57*	72	108	30	603	101.9	\$ 3914.00	
Consists of:							
-570 Left Single Ped Desk	72	36	30	296	55.1	\$ 1998.00	• Locking box / box / file drawer per pedestal
-571 Right Single Ped Credenza	72	24	30	228	40.2	\$ 1553.00	• Pencil tray in top box drawers
-59 U Bridge	48	24	30	79	6.6	\$ 363.00	• Removable divider in bottom box drawers
							• Grommets in corners of desk top
							• Grommets in credenza and bridge modesty panels
Right Executive U Desk (Flat Packed)							
702_-57FP	72	108	30	696	56.1	\$ 3116.00	
Consists of:							
-361 Desk Top, Modesty				119	7.5	\$ 418.00	
-363 Left B/B/F Pedestal				132	16.9	\$ 723.00	
-5702 Right Desk Support Ped				58	5.3	\$ 426.00	
-211 Credenza Top, Modesty				110	5.6	\$ 373.00	
-212 Right B/B/F Pedestal				99	12.1	\$ 585.00	
-2101 Left Credenza Support Pedestal				99	2.1	\$ 228.00	
-59 U Bridge				79	6.6	\$ 363.00	
Right Executive U Desk with White Glass Modesty*							
702_-57WG*	72	108	30	603	109.1	\$ 4014.00	
Consists of:							
-570WG Left Single Ped Desk	72	36	30	296	55.1	\$ 2098.00	
-571 Right Single Ped Credenza	72	24	30	228	40.2	\$ 1553.00	
-59 U Bridge	48	24	30	79	6.6	\$ 363.00	
Right Executive U Desk with White Glass Modesty (Flat Packed)							
702_-57WGFP	72	108	30	696	57.3	\$ 3146.00	
Consists of:							
-361WG Desk Top, Modesty				119	8.7	\$ 448.00	
-363 Left B/B/F Pedestal				132	16.9	\$ 723.00	
-5702 Right Desk Support Ped				58	5.3	\$ 426.00	
-211 Credenza Top, Modesty				110	5.6	\$ 373.00	
-212 Right B/B/F Pedestal				99	12.1	\$ 585.00	
-2101 Left Credenza Support Pedestal				99	2.1	\$ 228.00	
-59 U Bridge				79	6.6	\$ 363.00	
Right Executive U Desk with Laminate Modesty*							
702_-57L*	72	108	30	603	101.9	\$ 3975.00	
Consists of:							
-570L Left Single Ped Desk	72	36	30	296	55.1	\$ 2059.00	
-571 Right Single Ped Credenza	72	24	30	228	40.2	\$ 1553.00	
-59 U Bridge	48	24	30	79	6.6	\$ 363.00	
Right Executive U Desk with Laminate Modesty (Flat Packed)							
702_-57LFP	72	108	30	696	57.3	\$ 3123.00	
Consists of:							
-361L Desk Top, Modesty				119	8.7	\$ 425.00	
-363 Left B/B/F Pedestal				132	16.9	\$ 723.00	
-5702 Right Desk Support Ped				58	5.3	\$ 426.00	
-211 Credenza Top, Modesty				110	5.6	\$ 373.00	
-212 Right B/B/F Pedestal				99	12.1	\$ 585.00	
-2101 Left Credenza Support Pedestal				99	2.1	\$ 228.00	
-59 U Bridge				79	6.6	\$ 363.00	

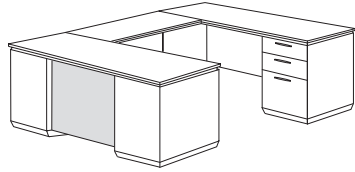

* Items within this collection marked with an asterisk are GSA items.

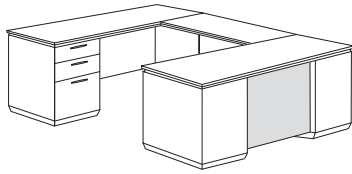

Item Description	Weight	Cubic	List	Features
Model Number	Lbs.	Ft.	Price	
Left Executive U Desk*				<ul style="list-style-type: none"> • Locking box / box / file drawer per pedestal • Pencil tray in top box drawers • Removable divider in bottom box drawers • Grommets in corners of desk top • Grommets in credenza and bridge modesty panels
702_-58*	603	101.9	\$ 3914.00	
Consists of:				
-580 Right Single Ped Desk	296	55.1	\$ 1998.00	
-581 Left Single Ped Credenza	228	40.2	\$ 1553.00	
-59 U Bridge	79	6.6	\$ 363.00	
Left Executive U Desk (Flat Packed)				
702_-58FP	696	56.1	\$ 3116.00	
Consists of:				
-361 Desk Top, Modesty	119	8.7	\$ 487.00	
-362 Right B/B/F Pedestal	132	16.9	\$ 723.00	
-5802 Left Desk Support Ped	58	5.3	\$ 426.00	
-211 Credenza Top, Modesty	110	5.6	\$ 373.00	
-213 Left B/B/F Pedestal	99	12.1	\$ 585.00	
-2102 Right Credenza Support Pedestal	99	2.1	\$ 228.00	
-59 U Bridge	79	6.6	\$ 363.00	
Left Executive U Desk with White Glass Modesty*				
702_-58WG*	603	101.9	\$ 4014.00	
Consists of:				
-580WG Right Single Ped Desk	296	55.1	\$ 2098.00	
-581 Left Single Ped Credenza	228	40.2	\$ 1553.00	
-59 U Bridge	79	6.6	\$ 363.00	
Left Executive U Desk with White Glass Modesty (Flat Packed)				
702_-58WGFP	696	57.3	\$ 3146.00	
Consists of:				
-361WG Desk Top, Modesty	119	8.7	\$ 448.00	
-362 Right B/B/F Pedestal	132	16.9	\$ 723.00	
-5802 Left Desk Support Ped	58	5.3	\$ 426.00	
-211 Credenza Top, Modesty	110	5.6	\$ 373.00	
-213 Left B/B/F Pedestal	99	12.1	\$ 585.00	
-2102 Right Credenza Support Pedestal	99	2.1	\$ 228.00	
-59 U Bridge	79	6.6	\$ 363.00	
Left Executive U Desk with Laminate Modesty*				
702_-58L*	603	101.9	\$ 3975.00	
Consists of:				
-580L Right Single Ped Desk	296	55.1	\$ 2059.00	
-581 Left Single Ped Credenza	228	40.2	\$ 1553.00	
-59 U Bridge	79	6.6	\$ 363.00	
Left Executive Bow Front U Desk with Laminate Modesty (Flat Packed)				
702_-58LFP	696	57.3	\$ 3123.00	
Consists of:				
-361L Desk Top, Modesty	119	8.7	\$ 425.00	
-362 Right B/B/F Pedestal	132	16.9	\$ 723.00	
-5802 Left Desk Support Ped	58	5.3	\$ 426.00	
-211 Credenza Top, Modesty	110	5.6	\$ 373.00	
-213 Left B/B/F Pedestal	99	12.1	\$ 585.00	
-2102 Right Credenza Support Pedestal	99	2.1	\$ 228.00	
-59 U Bridge	79	6.6	\$ 363.00	

* Items within this collection marked with an asterisk are GSA items.



7020 Mocha Finish / 7027 Walnut Finish

DMI COLLECTION

Item Description	Weight	Cubic	List				
Model Number	W"	D"	H"	Lbs.	Ft.	Price	Features
Right Bow Front U Desk with Lateral File*							
702_-537B*	72	114	30	652	112.1	\$ 4321.00	<ul style="list-style-type: none"> • Locking box / box / file drawer desk pedestal • Pencil tray in top box drawers • Removable divider in bottom box drawers • Two lateral file drawers in credenza • Lateral file is central locking • Grommets in corners of desk top • Grommets in credenza and bridge modesty panels
Consists of:							
-570B Left Single Ped Desk	72	42	30	325	65.3	\$ 2064.00	
-547 Right Lateral File Credenza	72	24	30	268	40.2	\$ 1894.00	
-59 U Bridge	48	24	30	79	6.6	\$ 363.00	
Right Bow Front U Desk with Lateral File (Flat Packed)							
702_-537BFP	72	114	30	756	65.6	\$ 3514.00	
Consists of:							
-371 Bow Desk Top, Modesty				128	8.7	\$ 487.00	
-363 Left B/B/F Pedestal				132	16.9	\$ 723.00	
-5702 Right Desk Support Ped				58	5.3	\$ 426.00	
-5401 Credenza Top, Modesty				128	5.6	\$ 373.00	
-5472 Lateral File Pedestal				132	20.4	\$ 914.00	
-2101 Left Credenza Support Pedestal				99	2.1	\$ 228.00	
-59 U Bridge				79	6.6	\$ 363.00	
Right Bow Front U Desk with White Glass Modesty and Lateral File*							
702_-537BWG*	72	114	30	652	112.1	\$ 4424.00	
Consists of:							
-570BWG Left Single Ped Desk	72	42	30	325	65.3	\$ 2167.00	
-547 Right Single Ped Credenza	72	24	30	268	40.2	\$ 1894.00	
-59 U Bridge	48	24	30	79	6.6	\$ 363.00	
Right Bow U Desk with White Glass Modesty and Lateral File (Flat Packed)							
702_-537BWGFP	72	114	30	756	66.8	\$ 3548.00	
Consists of:							
-371WG Bow Desk Top, Modesty				128	9.9	\$ 521.00	
-363 Left B/B/F Pedestal				132	16.9	\$ 723.00	
-5702 Right Desk Support Ped				58	5.3	\$ 426.00	
-5401 Credenza Top, Modesty				128	5.6	\$ 373.00	
-5472 Lateral File Pedestal				132	20.4	\$ 914.00	
-2101 Left Credenza Support Pedestal				99	2.1	\$ 228.00	
-59 U Bridge				79	6.6	\$ 363.00	
Right Bow Front U Desk with Laminate Modesty and Lateral File*							
702_-537BL*	72	114	30	652	112.1	\$ 4384.00	
Consists of:							
-570BL Left Single Ped Desk	72	42	30	325	65.3	\$ 2127.00	
-547 Right Lateral File Credenza	72	24	30	268	40.2	\$ 1894.00	
-59 U Bridge	48	24	30	79	6.6	\$ 363.00	
Right Bow Front U Desk with Laminate Modesty and Lateral File (Flat Packed)							
702_-537BLFP	72	114	30	756	66.8	\$ 3537.00	
Consists of:							
-371L Bow Desk Top, Modesty				128	9.9	\$ 510.00	
-363 Left B/B/F Pedestal				132	16.9	\$ 723.00	
-5702 Right Desk Support Ped				58	5.3	\$ 426.00	
-5401 Credenza Top, Modesty				128	5.6	\$ 373.00	
-5472 Lateral File Pedestal				132	20.4	\$ 914.00	
-2101 Left Credenza Support Pedestal				99	2.1	\$ 228.00	
-59 U Bridge				79	6.6	\$ 363.00	

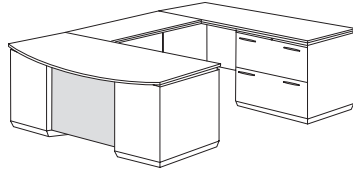

* Items within this collection marked with an asterisk are GSA items.

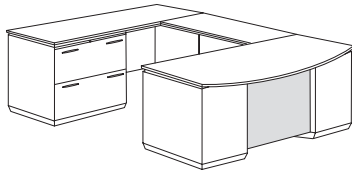

Item Description

Model Number

W" D" H"

Weight

Cubic

List

Features

Left Bow Front U Desk with Lateral File*

702_-538B*

72 114 30

652

112.1

\$

4321.00

Consists of:

-580B Right Single Ped Desk

72 42 30

325

65.3

\$

2064.00

-548 Left Lateral File Credenza

72 24 30

268

40.2

\$

1894.00

-59 U Bridge

48 24 30

79

6.6

\$

363.00

- Locking box / box / file drawer desk pedestal
- Pencil tray in top box drawers
- Removable divider in bottom box drawers
- Two lateral file drawers in credenza
- Lateral file is central locking
- Grommets in corners of desk top
- Grommets in credenza and bridge modesty panels

Left Bow Front U Desk with Lateral File (Flat Packed)

702_-538BFP

72 114 30

756

65.6

\$

3514.00

Consists of:

-371 Bow Desk Top, Modesty

128

8.7

\$

487.00

-362 Right B/B/F Pedestal

132

16.9

\$

723.00

-5802 Left Desk Support Ped

58

5.3

\$

426.00

-5401 Credenza Top, Modesty

128

5.6

\$

373.00

-5472 Lateral File Pedestal

132

20.4

\$

914.00

-2102 Right Credenza Support Pedestal

99

2.1

\$

228.00

-59 U Bridge

79

6.6

\$

363.00

Left Bow Front U Desk with White Glass Modesty and Lateral File*

702_-538BWG*

72 114 30

652

112.1

\$

4424.00

Consists of:

-580BWG Right Single Ped Desk

72 42 30

325

65.3

\$

2167.00

-548 Left Lateral File Credenza

72 24 30

268

40.2

\$

1894.00

-59 U Bridge

48 24 30

79

6.6

\$

363.00

Left Bow U Desk with White Glass Modesty and Lateral File (Flat Packed)

702_-538BWGFP

72 114 30

756

66.8

\$

3548.00

Consists of:

-371WG Bow Desk Top, Modesty

128

9.9

\$

521.00

-362 Right B/B/F Pedestal

132

16.9

\$

723.00

-5802 Left Desk Support Ped

58

5.3

\$

426.00

-5401 Credenza Top, Modesty

128

5.6

\$

373.00

-5472 Lateral File Pedestal

132

20.4

\$

914.00

-2102 Right Credenza Support Pedestal

99

2.1

\$

228.00

-59 U Bridge

79

6.6

\$

363.00

Left Bow Front U Desk with Laminate Modesty and Lateral File*

702_-538BL*

72 114 30

652

112.1

\$

4384.00

Consists of:

-580BL Right Single Ped Desk

72 42 30

325

65.3

\$

2127.00

-548 Left Lateral File Credenza

72 24 30

268

40.2

\$

1894.00

-59 U Bridge

48 24 30

79

6.6

\$

363.00

Left Bow Front U Desk with Laminate Modesty and Lateral File (Flat Packed)

702_-538BLFP

72 114 30

756

66.8

\$

3537.00

Consists of:

-371L Bow Desk Top, Modesty

128

9.9

\$

510.00

-362 Right B/B/F Pedestal

132

16.9

\$

723.00

-5802 Left Desk Support Ped

58

5.3

\$

426.00

-5401 Credenza Top, Modesty

128

5.6

\$

373.00

-5472 Lateral File Pedestal

132

20.4

\$

914.00

-2102 Right Credenza Support Pedestal

99

2.1

\$

228.00

-59 U Bridge

79

6.6

\$

363.00

* Items within this collection marked with an asterisk are GSA items.



7020 Mocha Finish / 7027 Walnut Finish

DMI COLLECTION

Item Description	Weight	Cubic	List	Features
Model Number	W" D" H"	Lbs. Ft.	Price	
Right Executive U Desk with Lateral File*				
702_-537*	72 108 30	643	101.9 \$	4255.00
Consists of:				
-570 Left Single Ped Desk	72 36 30	296	55.1 \$	1998.00
-547 Right Lateral File Credenza	72 24 30	268	40.2 \$	1894.00
-59 U Bridge	48 24 30	79	6.6 \$	363.00
Right Executive U Desk with Lateral File (Flat Packed)				
702_-537FP	72 108 30	747	64.4 \$	3445.00
Consists of:				
-361 Desk Top, Modesty		119	7.5 \$	418.00
-363 Left B/B/F Pedestal		132	16.9 \$	723.00
-5702 Right Desk Support Ped		58	5.3 \$	426.00
-5401 Credenza Top, Modesty		128	5.6 \$	373.00
-5472 Lateral File Pedestal		132	20.4 \$	914.00
-2101 Left Credenza Support Pedestal		99	2.1 \$	228.00
-59 U Bridge		79	6.6 \$	363.00
Right Executive U Desk with White Glass Modesty and Lateral File*				
702_-537WG*	72 108 30	643	109.1 \$	4355.00
Consists of:				
-570WG Left Single Ped Desk	72 36 30	296	55.1 \$	2098.00
-547 Right Lateral File Credenza	72 24 30	268	40.2 \$	1894.00
-59 U Bridge	48 24 30	79	6.6 \$	363.00
Right Executive U Desk with White Glass Modesty & Lateral File (Flat Packed)				
702_-537BWGFP	72 108 30	747	64.4 \$	3475.00
Consists of:				
-361WG Desk Top, Modesty		119	7.5 \$	448.00
-363 Left B/B/F Pedestal		132	16.9 \$	723.00
-5702 Right Desk Support Ped		58	5.3 \$	426.00
-5401 Credenza Top, Modesty		128	5.6 \$	373.00
-5472 Lateral File Pedestal		132	20.4 \$	914.00
-2101 Left Credenza Support Pedestal		99	2.1 \$	228.00
-59 U Bridge		79	6.6 \$	363.00
Right Executive U Desk with Laminate Modesty and Lateral File*				
702_-537L*	72 108 30	643	109.1 \$	4316.00
Consists of:				
-570L Left Single Ped Desk	72 36 30	296	55.1 \$	2059.00
-547 Right Lateral File Credenza	72 24 30	268	40.2 \$	1894.00
-59 U Bridge	48 24 30	79	6.6 \$	363.00
Right Executive U Desk with Laminate Modesty and Lateral File (Flat Packed)				
702_-537LFP	72 108 30	747	64.4 \$	3452.00
Consists of:				
-361L Desk Top, Modesty		119	7.5 \$	425.00
-363 Left B/B/F Pedestal		132	16.9 \$	723.00
-5702 Right Desk Support Ped		58	5.3 \$	426.00
-5401 Credenza Top, Modesty		128	5.6 \$	373.00
-5472 Lateral File Pedestal		132	20.4 \$	914.00
-2101 Left Credenza Support Pedestal		99	2.1 \$	228.00
-59 U Bridge		79	6.6 \$	363.00

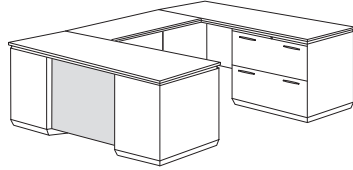

- Locking box / box / file drawer desk pedestal
- Pencil tray in top box drawers
- Removable divider in bottom box drawers
- Two lateral file drawers in credenza
- Lateral file is central locking
- Grommets in corners of desk top
- Grommets in credenza and bridge modesty panels

* Items within this collection marked with an asterisk are GSA items.

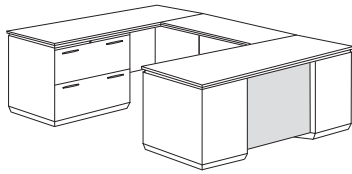

Item Description

Model Number

W" D" H"

Weight

Cubic

List

Price Features

Left Executive U Desk with Lateral File*

702_-538*

72 108 30

643

101.9

\$

4255.00

Consists of:

-580 Right Single Ped Desk
-548 Left Lateral File Credenza
-59 U Bridge

72 36 30
72 24 30
48 24 30

296
268
79

55.1
40.2
6.6

\$
\$
\$

1998.00
1894.00
363.00

- Locking box / box / file drawer desk pedestal
- Pencil tray in top box drawers
- Removable divider in bottom box drawers
- Two lateral file drawers in credenza
- Lateral file is central locking
- Grommets in corners of desk top
- Grommets in credenza and bridge modesty panels

Left Executive U Desk with Lateral File (Flat Packed)

702_-538FP

72 108 30

747

64.4

\$

3445.00

Consists of:

-361 Desk Top, Modesty
-362 Right B/B/F Pedestal
-5802 Left Desk Support Ped
-5401 Credenza Top, Modesty
-5472 Lateral File Pedestal
-2102 Right Credenza Support Pedestal
-59 U Bridge

119
132
58
128
132
99
79

7.5
16.9
5.3
5.6
20.4
2.1
6.6

\$
\$
\$
\$
\$
\$
\$

418.00
723.00
426.00
373.00
914.00
228.00
363.00

Left Executive U Desk with White Glass Modesty and Lateral File*

702_-538WG*

72 108 30

643

101.9

\$

4355.00

Consists of:

-580WG Right Single Ped Desk
-548 Left Lateral File Credenza
-59 U Bridge

72 36 30
72 24 30
48 24 30

296
268
79

55.1
40.2
6.6

\$
\$
\$

2098.00
1894.00
363.00

Left Executive U Desk with White Glass Modesty and Lateral File (Flat Packed)

702_-538WGFP

72 108 30

747

64.4

\$

3475.00

Consists of:

-361WG Desk Top, Modesty
-362 Right B/B/F Pedestal
-5802 Left Desk Support Ped
-5401 Credenza Top, Modesty
-5472 Lateral File Pedestal
-2102 Right Credenza Support Pedestal
-59 U Bridge

119
132
58
128
132
99
79

7.5
16.9
5.3
5.6
20.4
2.1
6.6

\$
\$
\$
\$
\$
\$
\$

448.00
723.00
426.00
373.00
914.00
228.00
363.00

Left Executive U Desk with Laminate Modesty and Lateral File*

702_-538L*

72 108 30

643

101.9

\$

4316.00

Consists of:

-580L Right Single Ped Desk
-548 Left Lateral File Credenza
-59 U Bridge

72 36 30
72 24 30
48 24 30

296
268
79

55.1
40.2
6.6

\$
\$
\$

2059.00
1894.00
363.00

Left Executive U Desk with Laminate Modesty and Lateral File (Flat Packed)

702_-538LFP

72 108 30

747

64.4

\$

3452.00

Consists of:

-361L Desk Top, Modesty
-362 Right B/B/F Pedestal
-5802 Left Desk Support Ped
-5401 Credenza Top, Modesty
-5472 Lateral File Pedestal
-2102 Right Credenza Support Pedestal
-59 U Bridge

119
132
58
128
132
99
79

7.5
16.9
5.3
5.6
20.4
2.1
6.6

\$
\$
\$
\$
\$
\$
\$

425.00
723.00
426.00
373.00
914.00
228.00
363.00

* Items within this collection marked with an asterisk are GSA items.



7020 Mocha Finish / 7027 Walnut Finish

DMI COLLECTION

Item Description	Weight	Cubic	List	
Model Number	Lbs.	Ft.	Price	Features
Right Bow Front U Desk with Personal File*				
702_-507B*	692	112.1	\$ 4321.00	<ul style="list-style-type: none"> • Locking box / box / file drawer desk pedestal • Box / box / personal file / lateral file in credenza • Pencil tray in top box drawers • Removable divider in bottom box drawers • Personal file is central locking • Grommets in corners of desk top • Grommets in credenza and bridge modesty panels
Consists of:				
-570B Left Single Ped Desk	325	65.3	\$ 2064.00	
-527 Right Personal File Credenza	288	40.2	\$ 1894.00	
-59 U Bridge	79	6.6	\$ 363.00	
Right Bow Front U Desk with Personal File (Flat Packed)				
702_-507BFP	787	65.6	\$ 3514.00	
Consists of:				
-371 Bow Desk Top, Modesty	128	8.7	\$ 487.00	
-363 Left B/B/F Pedestal	132	16.9	\$ 723.00	
-5702 Right Desk Support Ped	58	5.3	\$ 426.00	
-5401 Credenza Top, Modesty	128	5.6	\$ 373.00	
-5272 Personal File Pedestal	163	20.4	\$ 914.00	
-2101 Left Credenza Support Pedestal	99	2.1	\$ 228.00	
-59 U Bridge	79	6.6	\$ 363.00	
Right Bow Front U Desk with White Glass Modesty and Personal File*				
702_-507BWG*	692	112.1	\$ 4424.00	
Consists of:				
-570BWG Left Single Ped Desk	325	65.3	\$ 2167.00	
-527 Right Personal File Credenza	288	40.2	\$ 1894.00	
-59 U Bridge	79	6.6	\$ 363.00	
Right Bow U Desk with White Glass Modesty and Personal File (Flat Packed)				
702_-507BWGFP	787	66.8	\$ 3548.00	
Consists of:				
-371WG Bow Desk Top, Modesty	128	9.9	\$ 521.00	
-363 Left B/B/F Pedestal	132	16.9	\$ 723.00	
-5702 Right Desk Support Ped	58	5.3	\$ 426.00	
-5401 Credenza Top, Modesty	128	5.6	\$ 373.00	
-5272 Personal File Pedestal	163	20.4	\$ 914.00	
-2101 Left Credenza Support Pedestal	99	2.1	\$ 228.00	
-59 U Bridge	79	6.6	\$ 363.00	
Right Bow Front U Desk with Laminate Modesty and Personal File*				
702_-507BL*	692	112.1	\$ 4384.00	
Consists of:				
-570BL Left Single Ped Desk	325	65.3	\$ 2127.00	
-527 Right Personal File Credenza	288	40.2	\$ 1894.00	
-59 U Bridge	79	6.6	\$ 363.00	
Right Bow U Desk with Laminate Modesty and Personal File (Flat Packed)				
702_-507BLFP	787	66.8	\$ 3537.00	
Consists of:				
-371L Bow Desk Top, Modesty	128	9.9	\$ 510.00	
-363 Left B/B/F Pedestal	132	16.9	\$ 723.00	
-5702 Right Desk Support Ped	58	5.3	\$ 426.00	
-5401 Credenza Top, Modesty	128	5.6	\$ 373.00	
-5272 Personal File Pedestal	163	20.4	\$ 914.00	
-2101 Left Credenza Support Pedestal	99	2.1	\$ 228.00	
-59 U Bridge	79	6.6	\$ 363.00	

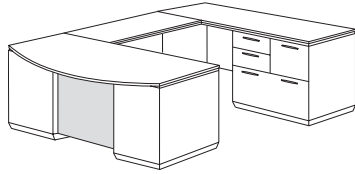

* Items within this collection marked with an asterisk are GSA items.

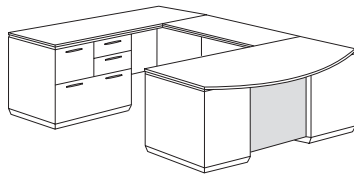

Item Description	Weight	Cubic	List	Features
Model Number	Lbs.	Ft.	Price	
Left Bow Front U Desk with Personal File*				
702_-508B*	692	112.1	\$ 4321.00	
Consists of:				
-580B Right Single Ped Desk	325	65.3	\$ 2064.00	• Locking box / box / file drawer desk pedestal
-528 Left Personal File Credenza	288	40.2	\$ 1894.00	• Box / box / personal file / lateral file in credenza
-59 U Bridge	79	6.6	\$ 363.00	• Pencil tray in top box drawers
				• Removable divider in bottom box drawers
				• Personal file is central locking
				• Grommets in corners of desk top
				• Grommets in credenza and bridge modesty panels
Left Bow Front U Desk with Personal File (Flat Packed)				
702_-508BFP	787	65.6	\$ 3514.00	
Consists of:				
-371 Bow Desk Top, Modesty	128	8.7	\$ 487.00	
-362 Right B/B/F Pedestal	132	16.9	\$ 723.00	
-5802 Left Desk Support Ped	58	5.3	\$ 426.00	
-5401 Credenza Top, Modesty	128	5.6	\$ 373.00	
-5272 Personal File Pedestal	163	20.4	\$ 914.00	
-2102 Right Credenza Support Pedestal	99	2.1	\$ 228.00	
-59 U Bridge	79	6.6	\$ 363.00	
Left Bow Front U Desk with White Glass Modesty and Personal File*				
702_-508BWG*	692	112.1	\$ 4424.00	
Consists of:				
-580BWG Right Single Ped Desk	325	65.3	\$ 2167.00	
-528 Left Personal File Credenza	288	40.2	\$ 1894.00	
-59 U Bridge	79	6.6	\$ 363.00	
Left Bow U Desk with White Glass Modesty and Personal File (Flat Packed)				
702_-508BWGFP	787	66.8	\$ 3548.00	
Consists of:				
-371WG Bow Desk Top, Modesty	128	9.9	\$ 521.00	
-362 Right B/B/F Pedestal	132	16.9	\$ 723.00	
-5802 Left Desk Support Ped	58	5.3	\$ 426.00	
-5401 Credenza Top, Modesty	128	5.6	\$ 373.00	
-5272 Personal File Pedestal	163	20.4	\$ 914.00	
-2102 Right Credenza Support Pedestal	99	2.1	\$ 228.00	
-59 U Bridge	79	6.6	\$ 363.00	
Left Bow Front U Desk with Laminate Modesty and Personal File*				
702_-508BL*	692	112.1	\$ 4384.00	
Consists of:				
-580BL Right Single Ped Desk	325	65.3	\$ 2127.00	
-528 Left Personal File Credenza	288	40.2	\$ 1894.00	
-59 U Bridge	79	6.6	\$ 363.00	
Left Bow U Desk with Laminate Modesty and Personal File (Flat Packed)				
702_-508BLFP	787	66.8	\$ 3537.00	
Consists of:				
-371L Bow Desk Top, Modesty	128	9.9	\$ 510.00	
-362 Right B/B/F Pedestal	132	16.9	\$ 723.00	
-5802 Left Desk Support Ped	58	5.3	\$ 426.00	
-5401 Credenza Top, Modesty	128	5.6	\$ 373.00	
-5272 Personal File Pedestal	163	20.4	\$ 914.00	
-2102 Right Credenza Support Pedestal	99	2.1	\$ 228.00	
-59 U Bridge	79	6.6	\$ 363.00	

* Items within this collection marked with an asterisk are GSA items.



7020 Mocha Finish / 7027 Walnut Finish

DMI COLLECTION

Item Description	Weight	Cubic	List				
Model Number	W"	D"	H"	Lbs.	Ft.	Price	Features
Right Executive U Desk with Personal File*							
702_-507*	72	108	30	663	101.9	\$ 4255.00	<ul style="list-style-type: none"> • Locking box / box / file drawer desk pedestal • Box / box / personal file / lateral file in credenza • Pencil tray in top box drawers • Removable divider in bottom box drawers • Personal file is central locking • Grommets in corners of desk top • Grommets in credenza and bridge modesty panels
Consists of:							
-570 Left Single Ped Desk	72	36	30	296	55.1	\$ 1998.00	
-527 Right Personal File Credenza	72	24	30	288	40.2	\$ 1894.00	
-59 U Bridge	48	24	30	79	6.6	\$ 363.00	
Right Executive U Desk with Personal File (Flat Packed)							
702_-507FP	72	108	30	778	64.4	\$ 3445.00	
Consists of:							
-361 Desk Top, Modesty				119	7.5	\$ 418.00	
-363 Left B/B/F Pedestal				132	16.9	\$ 723.00	
-5702 Right Desk Support Ped				58	5.3	\$ 426.00	
-5401 Credenza Top, Modesty				128	5.6	\$ 373.00	
-5272 Personal File Pedestal				163	20.4	\$ 914.00	
-2101 Left Credenza Support Pedestal				99	2.1	\$ 228.00	
-59 U Bridge				79	6.6	\$ 363.00	
Right Executive U Desk with White Glass Modesty and Personal File*							
702_-507WG*	72	108	30	663	101.9	\$ 4355.00	
Consists of:							
-570WG Left Single Ped Desk	72	36	30	296	55.1	\$ 2098.00	
-527 Right Personal File Credenza	72	24	30	288	40.2	\$ 1894.00	
-59 U Bridge	48	24	30	79	6.6	\$ 363.00	
Right U Desk with White Glass Modesty and Personal File (Flat Packed)							
702_-507WGFP	72	108	30	778	64.4	\$ 3475.00	
Consists of:							
-361WG Desk Top, Modesty				119	7.5	\$ 448.00	
-363 Left B/B/F Pedestal				132	16.9	\$ 723.00	
-5702 Right Desk Support Ped				58	5.3	\$ 426.00	
-5401 Credenza Top, Modesty				128	5.6	\$ 373.00	
-5272 Personal File Pedestal				163	20.4	\$ 914.00	
-2101 Left Credenza Support Pedestal				99	2.1	\$ 228.00	
-59 U Bridge				79	6.6	\$ 363.00	
Right Executive U Desk with Laminate Modesty and Personal File*							
702_-507L*	72	108	30	663	101.9	\$ 4316.00	
Consists of:							
-570L Left Single Ped Desk	72	36	30	296	55.1	\$ 2059.00	
-527 Right Personal File Credenza	72	24	30	288	40.2	\$ 1894.00	
-59 U Bridge	48	24	30	79	6.6	\$ 363.00	
Right Executive U Desk with Laminate Modesty and Personal File (Flat Packed)							
702_-507LFP	72	108	30	778	64.4	\$ 3452.00	
Consists of:							
-361L Desk Top, Modesty				119	7.5	\$ 425.00	
-363 Left B/B/F Pedestal				132	16.9	\$ 723.00	
-5702 Right Desk Support Ped				58	5.3	\$ 426.00	
-5401 Credenza Top, Modesty				128	5.6	\$ 373.00	
-5272 Personal File Pedestal				163	20.4	\$ 914.00	
-2101 Left Credenza Support Pedestal				99	2.1	\$ 228.00	
-59 U Bridge				79	6.6	\$ 363.00	

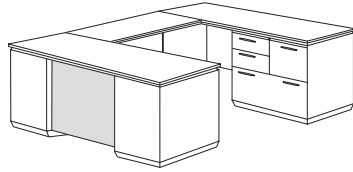

* Items within this collection marked with an asterisk are GSA items.

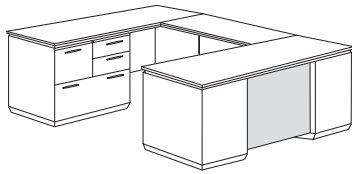



Item Description	Weight	Cubic	List	Features			
Model Number	W"	D"	H"	Lbs.	Ft.	Price	
Left Executive U Desk with Personal File*							
702_-508*	72	108	30	663	101.9	\$ 4255.00	<ul style="list-style-type: none"> • Locking box / box / file drawer desk pedestal • Box / box / personal file / lateral file in credenza • Pencil tray in top box drawers • Removable divider in bottom box drawers • Personal file is central locking • Grommets in corners of desk top • Grommets in credenza and bridge modesty panels
Consists of:							
-580 Right Single Ped Desk	72	36	30	296	55.1	\$ 1998.00	
-528 Left Personal File Credenza	72	24	30	288	40.2	\$ 1894.00	
-59 U Bridge	48	24	30	79	6.6	\$ 363.00	
Left Executive U Desk with Personal File (Flat Packed)							
702_-508FP	72	108	30	778	64.4	\$ 3445.00	
Consists of:							
-361 Desk Top, Modesty				119	7.5	\$ 418.00	
-362 Right B/B/F Pedestal				132	16.9	\$ 723.00	
-5802 Left Desk Support Ped				58	5.3	\$ 426.00	
-5401 Credenza Top, Modesty				128	5.6	\$ 373.00	
-5272 Personal File Pedestal				163	20.4	\$ 914.00	
-2102 Right Credenza Support Pedestal				99	2.1	\$ 228.00	
-59 U Bridge				79	6.6	\$ 363.00	
Left Executive U Desk with White Glass Modesty and Personal File*							
702_-508WG*	72	108	30	663	101.9	\$ 4355.00	
Consists of:							
-580WG Right Single Ped Desk	72	36	30	296	55.1	\$ 2098.00	
-528 Left Personal File Credenza	72	24	30	288	40.2	\$ 1894.00	
-59 U Bridge	48	24	30	79	6.6	\$ 363.00	
Left U Desk with White Glass Modesty and Personal File (Flat Packed)							
702_-508WGFP	72	108	30	778	64.4	\$ 3475.00	
Consists of:							
-361WG Desk Top, Modesty				119	7.5	\$ 448.00	
-362 Right B/B/F Pedestal				132	16.9	\$ 723.00	
-5802 Left Desk Support Ped				58	5.3	\$ 426.00	
-5401 Credenza Top, Modesty				128	5.6	\$ 373.00	
-5272 Personal File Pedestal				163	20.4	\$ 914.00	
-2102 Right Credenza Support Pedestal				99	2.1	\$ 228.00	
-59 U Bridge				79	6.6	\$ 363.00	
Left Executive U Desk with Laminate Modesty and Personal File*							
702_-508L*	72	108	30	663	101.9	\$ 4316.00	
Consists of:							
-580L Right Single Ped Desk	72	36	30	296	55.1	\$ 2059.00	
-528 Left Personal File Credenza	72	24	30	288	40.2	\$ 1894.00	
-59 U Bridge	48	24	30	79	6.6	\$ 363.00	
Left Executive U Desk with Laminate Modesty and Personal File (Flat Packed)							
702_-508LFP	72	108	30	778	64.4	\$ 3452.00	
Consists of:							
-361L Desk Top, Modesty				119	7.5	\$ 425.00	
-362 Right B/B/F Pedestal				132	16.9	\$ 723.00	
-5802 Left Desk Support Ped				58	5.3	\$ 426.00	
-5401 Credenza Top, Modesty				128	5.6	\$ 373.00	
-5272 Personal File Pedestal				163	20.4	\$ 914.00	
-2102 Right Credenza Support Pedestal				99	2.1	\$ 228.00	
-59 U Bridge				79	6.6	\$ 363.00	

* Items within this collection marked with an asterisk are GSA items.

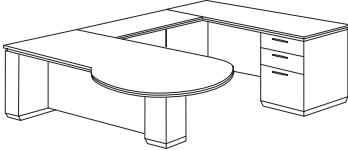
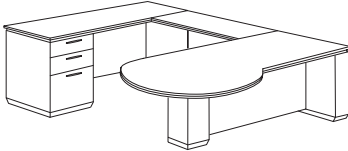

7020 Mocha Finish / 7027 Walnut Finish

DMI COLLECTION

	Item Description	Weight	Cubic	List	
	Model Number	W" D" H"	Lbs.	Ft.	Price Features
 Right	Right Peninsula U Desk 702_-647	72 114 30	543	62.0	\$ 2841.00
	Consists of:				
	-520 Left Peninsula Top, Panels	72 42 30	190	11.0	\$ 666.00
	-113 Peninsula Desk Post		46	4.2	\$ 259.00
	-571 Right Single Pedestal Credenza	72 24 30	228	40.2	\$ 1553.00
-59 U Bridge	48 24 30	79	6.6	\$ 363.00	
 Right	Right Peninsula U Desk (Flat Packed) 702_-647FP	72 114 30	623	41.6	\$ 2474.00
	Consists of:				
	-520 Left Peninsula Top, Panels	72 42 30	190	11.0	\$ 666.00
	-113 Peninsula Desk Post		46	4.2	\$ 259.00
	-211 Credenza Top, Modesty		110	5.6	\$ 373.00
-212 Right B/B/F Pedestal		99	12.1	\$ 585.00	
-2101 Left Credenza Support Pedestal		99	2.1	\$ 228.00	
-59 U Bridge		79	6.6	\$ 363.00	
 Left	Left Peninsula L Desk 702_-648	72 114 30	543	62.0	\$ 2841.00
	Consists of:				
	-530 Right Peninsula Top, Panels	72 42 30	190	11.0	\$ 666.00
	-113 Peninsula Desk Post		46	4.2	\$ 259.00
	-581 Left Single Pedestal Credenza	72 24 30	228	40.2	\$ 1553.00
-59 U Bridge	48 24 30	79	6.6	\$ 363.00	
 Left	Left Peninsula L Desk (Flat Packed) 702_-648FP	72 114 30	623	41.6	\$ 2474.00
	Consists of:				
	-530 Right Peninsula Top, Panels	72 42 30	190	11.0	\$ 666.00
	-113 Peninsula Desk Post		46	4.2	\$ 259.00
	-211 Credenza Top, Modesty		110	5.6	\$ 373.00
-213 Left B/B/F Pedestal		99	12.1	\$ 585.00	
-2102 Right Credenza Support Pedestal		99	2.1	\$ 228.00	
-59 U Bridge		79	6.6	\$ 363.00	

- Locking box / box / file drawer credenza pedestal
- Pencil tray in top box drawers
- Removable divider in bottom box drawers
- -520/-530 require assembly
- Grommet in corner of desk top
- Grommets in credenza and bridge modesty panels

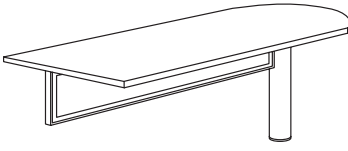
 Right	Workstation Peninsula Extension with Metal Post				
	702_-620FG	66 30 30	175	6.8	\$ 731.00
	702_-620WG	66 30 30	175	6.8	\$ 814.00
	702_-620L	66 30 30	175	6.8	\$ 762.00

- -620FG has a frosted glass modesty panel
- -620WG has a white glass modesty panel
- -620L has a laminate modesty panel

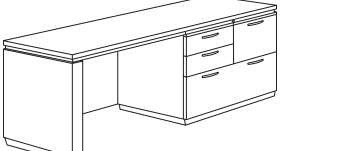
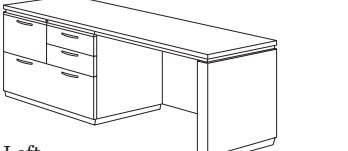
 Right	Right Single Personal File Credenza* 702_-627*	70 24 30	285	40.2	\$ 1597.00
	Right Single Personal File Credenza (Flat Packed) 702_-627FP	70 24 30	314	30.0	\$ 1391.00
	Consists of:				
	-611 Credenza Top, Modesty Panel		93	5.8	\$ 335.00
-6702 Right Credenza Support Pedestal		58	3.0	\$ 142.00	
-5272 Personal File Pedestal		163	20.4	\$ 914.00	
 Left	Left Single Personal File Credenza* 702_-628*	70 24 30	285	40.2	\$ 1597.00
	Left Single Personal File Credenza (Flat Packed) 702_-628FP	70 24 30	314	30.0	\$ 1391.00
	Consists of:				
	-611 Credenza Top, Modesty Panel		93	5.8	\$ 335.00
-6802 Left Credenza Support Pedestal		58	3.0	\$ 142.00	
-5272 Personal File Pedestal		163	20.4	\$ 914.00	

- Box / box / personal file / lateral file in pedestal
- Central locking pedestal
- Pencil tray in the top box drawer
- Removable divider in bottom box drawer
- Designed for use with the -620FG, -620WG, -620L
- Grommet in modesty panel

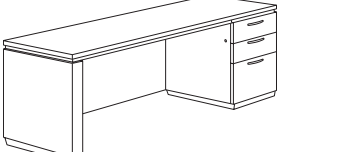
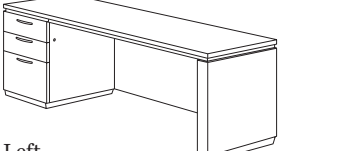
 Right	Right Single Pedestal Credenza* 702_-771*	70 24 30	228	40.2	\$ 1288.00
	Right Single Pedestal Credenza (Flat Packed) 702_-771FP	70 24 30	250	20.9	\$ 1062.00
	Consists of:				
	-611 Credenza Top, Modesty Panel		93	5.8	\$ 335.00
-6702 Right Credenza Support Pedestal		58	3.0	\$ 142.00	
-212 Right B/B/F Pedestal		99	12.1	\$ 585.00	
 Left	Left Single Pedestal Credenza* 702_-781*	70 24 30	228	40.2	\$ 1288.00
	Left Single Pedestal Credenza (Flat Packed) 702_-781FP	70 24 30	250	20.9	\$ 1062.00
	Consists of:				
	-611 Credenza Top, Modesty Panel		93	5.8	\$ 335.00
-6802 Left Credenza Support Pedestal		58	3.0	\$ 142.00	
-213 Left B/B/F Pedestal		99	12.1	\$ 585.00	







- Locking box / box / file drawer pedestal
- Pencil tray in the top box drawer
- Removable divider in bottom box drawer
- Designed for use with the -620FG, -620WG, -620L
- Grommet in modesty panel

* Items within this collection marked with an asterisk are GSA items.

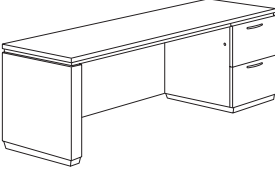
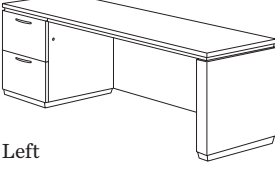

DMI COLLECTION

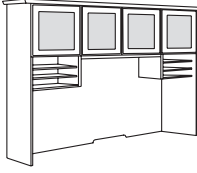
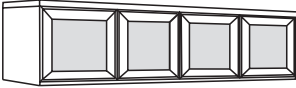
7020 Mocha Finish / 7027 Walnut Finish







	Item Description	W"	D"	H"	Weight Lbs.	Cubic Ft.	List Price	Features
	Right Single Lateral File Credenza* 702_-847*	70	24	30	268	40.2	\$ 1597.00	<ul style="list-style-type: none"> • Two lateral file drawers in pedestal • Central locking pedestal • Designed for use with the -620FG, -620WG, -620L
	Right Single Lateral File Credenza (Flat Packed) 702_-847FP Consists of: -611 Credenza Top, Modesty Panel -6702 Right Credenza Support Pedestal -5472 Lateral File Pedestal	70	24	30	314	29.2	\$ 1391.00	<ul style="list-style-type: none"> • Grommet in modesty panel
Right								
	Left Single Lateral File Credenza* 702_-848*	70	24	30	268	40.2	\$ 1597.00	
	Left Single Lateral File Credenza (Flat Packed) 702_-848FP Consists of: -611 Credenza Top, Modesty Panel -6802 Left Credenza Support Pedestal -5472 Lateral File Pedestal	70	24	30	314	29.2	\$ 1391.00	
Left								
	Right Single File Pedestal Credenza* 702_-871*	70	24	30	228	40.2	\$ 1391.00	<ul style="list-style-type: none"> • Locking file / file drawer pedestal • Designed for use with the -620FG, -620WG, -620L
	Right Single File Pedestal Credenza (Flat Packed) 702_-871FP Consists of: -611 Credenza Top, Modesty Panel -6702 Right Credenza Support Pedestal -812 Right F/F Pedestal	70	24	30	250	20.9	\$ 1186.00	<ul style="list-style-type: none"> • Grommet in modesty panel
Right								
	Left Single File Pedestal Credenza* 702_-872*	70	24	30	228	40.2	\$ 1391.00	
	Left Single File Pedestal Credenza (Flat Packed) 702_-872FP Consists of: -611 Credenza Top, Modesty Panel -6802 Left Credenza Support Pedestal -813 Left F/F Pedestal	70	24	30	250	20.9	\$ 1186.00	
Left								
	Mobile Pedestal 702_-70	18	18	22.25	85	7.2	\$ 592.00	<ul style="list-style-type: none"> • Box with a pencil tray / file drawer • White vinyl upholstered top
	Overhead Storage with Frosted Glass Doors 702_-61	66	16	42	120	37.2	\$ 1703.00	<ul style="list-style-type: none"> • Two cabinets with frosted or white glass doors • Letter storage • 24" center vertical clearance for monitor • -61 & -61WG for use with -19, -19FP • -62 & -62WG for use with -21, -21FP, -20, -571, -581, -547, -548
	702_-62	72	16	42	215	40.3	\$ 1880.00	
	Overhead Storage with White Glass Doors 702_-61WG	66	16	42	120	37.2	\$ 1703.00	
	702_-62WG	72	16	42	215	40.3	\$ 1880.00	
	Wall Mountable Overhead Storage with Frosted Glass Doors 702_-404	70	16	18	143	19.1	\$ 1029.00	<ul style="list-style-type: none"> • Two cabinets with frosted or white glass doors • Mounts to wall with Z-Rail and screws • Can be attached to -01 left single wardrobe, -02 right single wardrobe, -06 double wardrobe, or -07 lateral file cabinet • For use with -215, -215FP in wall unit applications
	Wall Mountable Overhead Storage with White Glass Doors 702_-404WG	70	16	18	143	19.1	\$ 1029.00	
	Lateral File 702_-16	36	24	30	183	21.8	\$ 1088.00	<ul style="list-style-type: none"> • Two lateral file drawers • Central locking • Equipped with an anti-tip device
	Lateral File Storage Cabinet 702_-07	36	24.25	72	323	48.5	\$ 2145.00	<ul style="list-style-type: none"> • Two lateral file drawers with central locking • Cabinet with two adjustable shelves

* Items within this collection marked with an asterisk are GSA items.

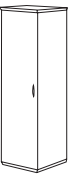
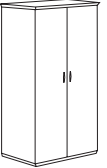
Pimlico LAMINATE COLLECTION

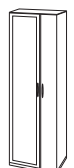

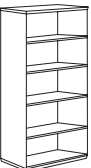
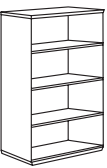

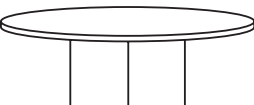
7020 Mocha Finish / 7027 Walnut Finish

DMI COLLECTION

		Item Description	W"	D"	H"	Weight	Cubic	List	
		Model Number				Lbs.	Ft.	Price	Features
Left		Left Single Wardrobe/Cabinet 702_-01	18	24	72	169	26.1	\$ 1205.00	<ul style="list-style-type: none"> • Four adjustable/ removable shelves • Metal hanger rod
	Right		Right Single Wardrobe/Cabinet 702_-02	18	24	72	169	\$ 1205.00	
		Double Wardrobe/Cabinet 702_-06	36	24.25	72	312	48.5	\$ 2087.00	<ul style="list-style-type: none"> • Two cabinets, each with four adjustable shelves • Metal hanger rod in left cabinet
Left		Left Hand Facing Bookcase Wardrobe 702_-08LHL	24	24	72	183	36.1	\$ 1391.00	<ul style="list-style-type: none"> • 14.5" wide cabinet with four adjustable shelves • 7" wide cabinet with a hanger rode
	Right		Right Hand Facing Bookcase Wardrobe 702_-08RHL	24	24	72	183	\$ 1391.00	
Left		Left Hand Facing Bookcase Wardrobe with White Glass Door 702_-08LHWG	24	24	72	183	36.1	\$ 1437.00	<ul style="list-style-type: none"> • 14.5" wide cabinet with four adjustable shelves • 7" wide cabinet with a hanger rode • White glass on larger door and laminate on smaller door • Frosted glass not available
	Right		Right Hand Facing Bookcase Wardrobe with White Glass Door 702_-08RHWG	24	24	72	183	\$ 1437.00	
		Bookcase 702_-09	36	16	72	198	33.9	\$ 1361.00	<ul style="list-style-type: none"> • Open storage with two adjustable shelves • Cabinet with an adjustable shelf
		Open Bookcase* 702_-108*	36	16	72	176	33.2	\$ 1473.00	<ul style="list-style-type: none"> • Four adjustable shelves
		Open Bookcase (Flat Packed) 702_-108FP	36	16	72	176	10.4	\$ 1332.00	
		Open Bookcase* 702_-158*	36	16	54	134	23.0	\$ 1132.00	<ul style="list-style-type: none"> • Three adjustable shelves
		Open Bookcase (Flat Packed) 702_-158FP	36	16	54	134	7.7	\$ 936.00	
		Open Bookcase* 702_-148*	36	16	42	112	19.8	\$ 1029.00	<ul style="list-style-type: none"> • Two adjustable shelves
		Open Bookcase (Flat Packed) 702_-148FP	36	16	42	112	6.3	\$ 837.00	
		42" Round Conference Table 702_-89	42	42	30	108	11.8	\$ 540.00	
		Consists of:							
		-011 Top	42	42		46	3.7	\$ 230.00	
		-002 Square Pedestal Base	18	18		62	8.1	\$ 310.00	

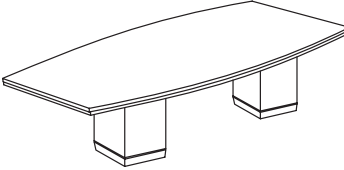
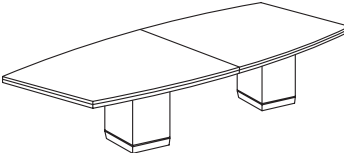
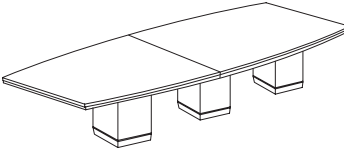
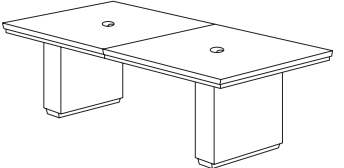
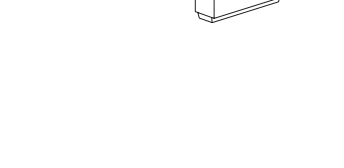
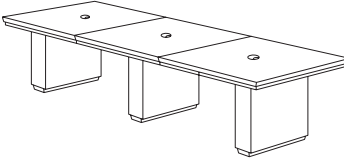
* Items within this collection marked with an asterisk are GSA items.

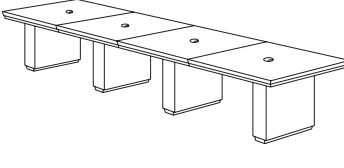

	Item Description	W"	D"	H"	Weight Lbs.	Cubic Ft.	List Price	Features
	8' Boat Top Conference Table							
	702_-96	96	42	30	279	30.9	\$ 1578.00	
	Consists of:							
	-004 Top	96	42		155	14.7	\$ 958.00	
	-002 Square Pedestal Base (2 needed)	18	18		124	16.2	\$ 620.00	
	10' Boat Top Conference Table							
	702_-120	120	48	30	284	37.3	\$ 1852.00	
	Consists of:							
	-005 Two Piece Top	120	48		160	21.1	\$ 1232.00	
	-002 Square Pedestal Base (2 needed)	18	18		124	16.2	\$ 620.00	
	12' Boat Top Conference Table							
	702_-144	144	48	30	381	48.3	\$ 2196.00	
	Consists of:							
	-006 Two Piece Top	120	48		195	24.0	\$ 1266.00	
	-002 Square Pedestal Base (3 needed)	18	18		186	24.3	\$ 930.00	
	8' Rectangular Expandable Conference Table							
	702_-96REX	96	48	30	433	29.6	\$ 1983.00	
	Consists of:							
	-9028 Left & Right Tops	48	48		233	12.5	\$ 1132.00	
	-9033 Bases (2 needed)	28	5.25	29	188	16.0	\$ 722.00	
	-9034 Rail Set	45			12	1.0	\$ 129.00	
	10' Rectangular Expandable Conference Table							
	702_-120REX	120	48	30	455	32.8	\$ 2313.00	
	Consists of:							
	-9029 Left & Right Tops	60	48		245	15.1	\$ 1391.00	
	-9033 Bases (2 needed)	28	5.25	29	188	16.0	\$ 722.00	
	-9038 Rail Set	69.5			22	1.7	\$ 200.00	
	12' Rectangular Expandable Conference Table							
	702_-144REX	144	48	30	696	51.2	\$ 3781.00	
	Consists of:							
	-9028 Left & Right Tops	48	48		233	12.5	\$ 1132.00	
	-9032 Center Top & Rails	48	48		145	12.5	\$ 1288.00	
	-9033 Bases (3 needed)	28	5.25	29	282	24.0	\$ 1083.00	
	-9035 Rail Set (2 needed)	42.5			36	2.2	\$ 278.00	
	14' Rectangular Expandable Conference Table							
	702_-168REX	168	48	30	712	54.2	\$ 4102.00	
	Consists of:							
	-9029 Left & Right Tops	60	48		245	15.1	\$ 1391.00	
	-9032 Center Top & Rails	48	48		145	12.5	\$ 1288.00	
	-9033 Bases (3 needed)	28	5.25	29	282	24.0	\$ 1083.00	
	-9037 Rail Set (2 needed)	55			40	2.6	\$ 340.00	
	16' Rectangular Expandable Conference Table							
	702_-192REX	192	48	30	935	71.7	\$ 5430.00	
	Consists of:							
	-9028 Left & Right Tops	48	48		233	12.5	\$ 1132.00	
	-9032 Center Top & Rails (2 needed)	48	48		290	25.0	\$ 2576.00	
	-9033 Bases (4 needed)	28	5.25	29	376	32.0	\$ 1444.00	
	-9035 Rail Set (2 needed)	42.5			36	2.2	\$ 278.00	
	18' Rectangular Expandable Conference Table							
	702_-216REX	216	48	30	951	74.7	\$ 5751.00	
	Consists of:							
	-9029 Left & Right Tops	60	48		245	15.1	\$ 1391.00	
	-9032 Center Top & Rails (2 needed)	48	48		290	25.0	\$ 2576.00	
	-9033 Bases (4 needed)	28	5.25	29	376	32.0	\$ 1444.00	
	-9037 Rail Set (2 needed)	55			40	2.6	\$ 340.00	

- Grommet in each top section
- White tops available (7022)
- Optional storage base, -107, available
- Grommets accommodate optional 0000-38 Hide-A-Dock or 0000-42 Pop-up Station

- Grommet in each top section
- White tops available (7022)
- Optional storage base, -107, available
- Grommets accommodate optional 0000-38 Hide-A-Dock or 0000-42 Pop-up Station

- Grommet in each top section
- White tops available (7022)
- Optional storage base, -107, available
- Grommets accommodate optional 0000-38 Hide-A-Dock or 0000-42 Pop-up Station

* Items within this collection marked with an asterisk are GSA items.



7020 Mocha Finish / 7027 Walnut Finish

DMI COLLECTION

Item Description	W"	D"	H"	Weight Lbs.	Cubic Ft.	List Price	Features
20' Rectangular Expandable Conference Table 702_-240REX Consists of: -9028 Left & Right Tops -9032 Center Top & Rails (3 needed) -9033 Bases (5 needed) -9035 Rail Set (2 needed)	240	48	30	1174	92.2	\$ 7079.00	<ul style="list-style-type: none"> • Grommet in each top section • White tops available (7022) • Optional storage base, -107, available • Grommets accommodate optional 0000-38 Hide-A-Dock or 0000-42 Pop-up Station
22' Rectangular Expandable Conference Table 702_-264REX Consists of: -9029 Left & Right Tops -9032 Center Top & Rails (3 needed) -9033 Bases (5 needed) -9037 Rail Set (2 needed)	264	48	30	1190	95.2	\$ 7400.00	
48" Left and Right Section Rectangular Expandable Conference Table Top 702_-9028	96	48		233	12.5	\$ 1132.00	<ul style="list-style-type: none"> • Satin aluminum finish base accent • Grommet in each top section • -9028 includes two 48" section tops
White 48" Left & Right Section Rectangular Expandable Conference Table Top 7022-9028	96	48		233	12.5	\$ 1132.00	<ul style="list-style-type: none"> • -9029 includes two 60" section tops • Grommets accommodate optional 0000-38 Hide-A-Dock or 0000-42 Pop-up Station
60" Left and Right Section Rectangular Expandable Conference Table Top 702_-9029	120	48		245	15.1	\$ 1391.00	
White 60" Left & Right Section Rectangular Expandable Conference Table Top 7022-9029	120	48		245	15.1	\$ 1391.00	
48" Center Section Expandable Conference Table Top with 44" Rails 702_-9032	48	48		145	12.5	\$ 1288.00	<ul style="list-style-type: none"> • Grommet in top • Grommet accommodates optional 0000-38 Hide-A-Dock or 0000-42 Pop-up Station
White 48" Center Section Expandable Conference Table Top with 44" Rails 7022-9032	48	48		145	12.5	\$ 1288.00	
Expandable Conference Table Base 702_-9033	28	5.25	29	94	8.0	\$ 361.00	<ul style="list-style-type: none"> • -017 must be placed at the end of the table
Expandable Conference Table Storage Base 702_-017	28	5.25	29	94	8.0	\$ 386.00	
48" Center Section Top and Base 702_-903233 Consists of: -9032 Center Top & Rails -9033 Base	48	48	30	239	20.5	\$ 1649.00	<ul style="list-style-type: none"> • Grommet in top • Grommet accommodates optional 0000-38 Hide-A-Dock or 0000-42 Pop-up Station
Expandable Conference Table Rail Sets 702_-9034 702_-9035 702_-9037 702_-9038	45 42.5 55 69.5			12 18 20 22	1.1 1.1 1.3 1.7	\$ 129.00 \$ 139.00 \$ 170.00 \$ 200.00	<ul style="list-style-type: none"> • -9034 rail set for 8' expandable tables • -9035 rail set for 48" section tops • -9037 rail set for 60" section tops • -9038 rail set for 10' expandable tables
Buffet 702_-25	66	24	36	325	47.3	\$ 2055.00	<ul style="list-style-type: none"> • Two felt-lined fully extending drawers with one having a silverware holder • Two cabinets each with an adjustable shelf • Heavy duty locking casters • Optional 0000-40 Power Center (see Accessories section) is ideal when using a TV or other electronics with the buffet



DMI COLLECTION

7020 Mocha Finish / 7027 Walnut Finish

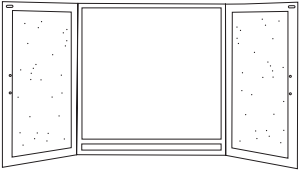
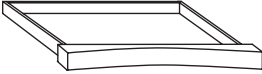
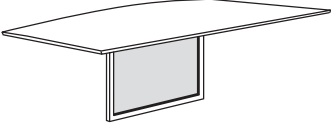
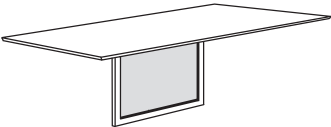
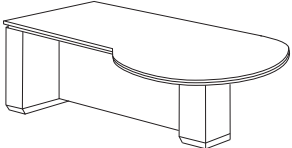
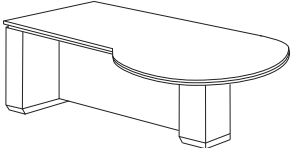
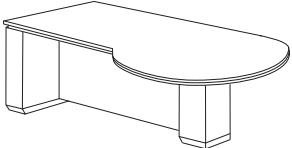
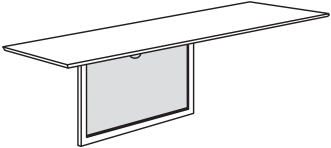
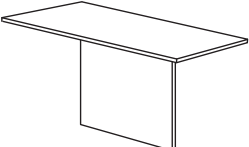
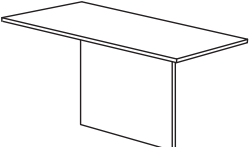
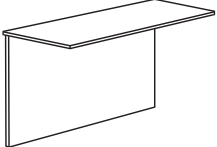
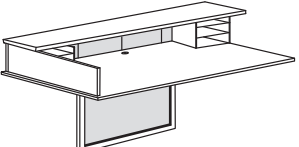
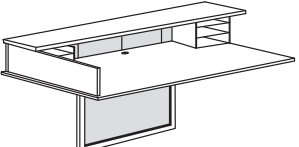
Item Description	W"	D"	H"	Weight	Cubic	List	Features
Model Number				Lbs.	Ft.	Price	
 Presentation Board 702_-650	48	4.25	48	123	12.1	\$ 1071.00	<ul style="list-style-type: none"> • Open: 96" x 2.75" x 48" • White, magnetic steel marker board • Cork tack board on the interior of each door • Magnetic door latches; door stays stop doors at 180 degrees • Hangs on wall with "Z" rails and screws.
 Optional Center/Keyboard Drawer 702_-701 702_-702	33.5 27.5	19.75 19.75	3.25 3.25	10 10	3.4 2.8	\$ 259.00 \$ 245.00	<ul style="list-style-type: none"> • Drop-front • 2.75" box height • -701 for use with 72" double and single pedestal desks or credenzas • -702 for use with 66" double and single pedestal desks and 48" returns
 Bow Front Desk Tops, Modesty Panels 702_-371 702_-371WG 702_-371L	72	42		128 128 128	8.7 9.9 8.7	\$ 487.00 \$ 521.00 \$ 510.00	<ul style="list-style-type: none"> • -371 has a frosted glass modesty panel • -371WG has a white glass modesty panel • -371L has a laminate modesty panel
 Desk Tops, Modesty Panels 702_-361 702_-361WG 702_-361L 702_-301 702_-301WG 702_-301L	72	36		119 119 119 99 99 99	7.5 7.5 7.5 5.9 5.9 5.9	\$ 418.00 \$ 448.00 \$ 425.00 \$ 350.00 \$ 369.00 \$ 363.00	<ul style="list-style-type: none"> • -361, -301 have frosted glass modesty panels • -371WG has a white glass modesty panel • -361WG, -301WG have white glass modesty panels • -361L, -301L have laminate modesty panels
 Left Peninsula Desk Shell 702_-520	72	42	30	190	11.0	\$ 666.00	<ul style="list-style-type: none"> • -520/-530 require -113 post
 Right Peninsula Desk Shell 702_-530	72	42	30	190	11.0	\$ 666.00	
 Peninsula Desk Post 702_-113				46	4.2	\$ 259.00	
 Credenza Tops, Modesty Panels 702_-211 702_-2151 702_-191 702_-5401 702_-611	72 70 66 72 70	24 24 24 24 24		93 101 90 128 93	5.6 5.4 5.2 5.6 5.8	\$ 373.00 \$ 328.00 \$ 250.00 \$ 373.00 \$ 335.00	<ul style="list-style-type: none"> • -611 designed for use with the -620, -620WG, -620L
 Right Return Top, Modesty Panel 702_-5791	48	24		79	4.3	\$ 328.00	
 Left Return Top, Modesty Panel 702_-5891	48	24		79	4.3	\$ 328.00	
 Bridge 702_-59	48	24	30	79	6.6	\$ 363.00	
 Left Reception Desk Top, Hutch, Modesty Panel 702_-681	72	36	42	120	11.9	\$ 1210.00	
 Right Reception Desk Top, Hutch, Modesty Panel 702_-691	72	36	42	120	11.9	\$ 1210.00	



7020 Mocha Finish / 7027 Walnut Finish

DMI COLLECTION

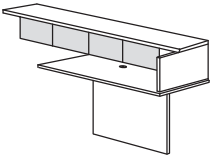
Item Description	Model Number	W"	D"	H"	Weight Lbs.	Cubic Ft.	List Price	Features
	Right Reception Return Top, Hutch, Modesty Panel 702_-1791	48	42	42	80	10.1	\$ 567.00	
	Left Reception Desk Top, Hutch, Modesty Panel 702_-1891	48	42	42	80	10.1	\$ 567.00	

	Right Assembled Pedestals							
	702_-362				132	16.9	\$ 723.00	• Locking box / box / file drawer pedestal
	702_-302				119	13.0	\$ 655.00	• Pencil tray in the top box drawer
	702_-212				99	12.1	\$ 585.00	• Removable divider in bottom box drawer
	Left Assembled Pedestals							
	702_-363				132	16.9	\$ 723.00	
	702_-303			119	13.0	\$ 655.00		
	702_-213			99	12.1	\$ 585.00		

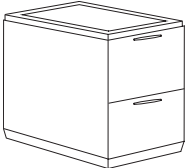
	Right Assembled File / File Pedestal 702_-812				99	12.1	\$ 709.00	• Locking file / file pedestal
	Left Assembled File / File Pedestal 702_-813				99	12.1	\$ 709.00	

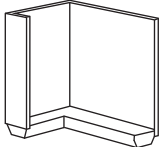
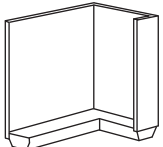
	Right Support Pedestals							
	702_-5702				58	5.3	\$ 426.00	
	702_-2102				99	2.1	\$ 228.00	
	702_-2702				49	3.0	\$ 396.00	
	702_-6702				58	3.0	\$ 142.00	
	Left Support Pedestals							
	702_-5802				58	5.3	\$ 426.00	
	702_-2101				99	2.1	\$ 228.00	
	702_-2802				49	3.0	\$ 396.00	
	702_-6802				58	3.0	\$ 142.00	

	Lateral File Pedestal 702_-5472				132	20.4	\$ 914.00	• Central locking pedestal
--	---	--	--	--	-----	------	-----------	----------------------------

	Personal File Pedestal 702_-5272				163	20.4	\$ 914.00	• Box / box / personal file / lateral file in pedestal • Central locking pedestal • Pencil tray in the top box drawer • Removable divider in bottom box drawer
--	--	--	--	--	-----	------	-----------	---



Writing Desks

For specifications, see individual collections.



FLEXSTEEL®
CONTRACT



DMI COLLECTION

Writing Desks

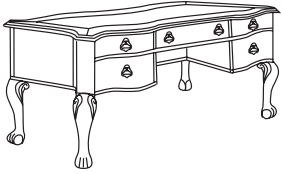
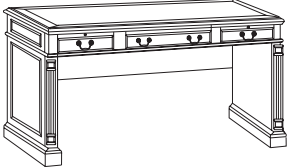
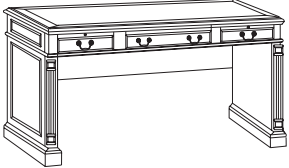

FLEXSTEEL®
CONTRACT

DMI COLLECTION

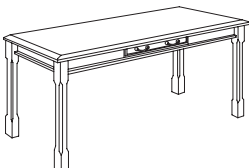
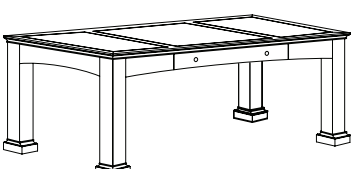
Item Description Model Number	W"	D"	H"	Weight Lbs.	Cubic Ft.	List Price	Features
 <p>Balmoor Writing Desk 7688-88</p>	72	36	30	272	60.6	\$ 2875.00	<ul style="list-style-type: none"> • Bordeaux Cherry finish • Center keyboard drawer with a drop-front permits use as a traditional center drawer or a keyboard drawer • Center drawer is cable accessible • Left pedestal has two box drawers with top box having felt lining and finished pencil tray
 <p>Keswick Table Desk 7990-88</p>	72	36	30	320	60.1	\$ 2875.00	<ul style="list-style-type: none"> • English Cherry finish • Three drawers • Two pull-out writing boards
 <p>Keswick Table Desk with HPL Top 7990-88HPL</p>	72	36	30	320	60.1	\$ 2875.00	
 <p>Walden Writing Desk 7859-88</p>	48	24	30	198	31.3	\$ 1433.00	<ul style="list-style-type: none"> • Cocoa Cherry finish • Center keyboard drawer with drop-front, pencil tray • Two utility drawers • Grommet in top
 <p>Governors Table Desk 7350-88</p>	72	36	30	175	15.2	\$ 1562.00	<ul style="list-style-type: none"> • Engraved Executive Mahogany finish • Center drawer with a pencil tray
 <p>Del Mar Table Desk 7302-88</p> <p>Consists of: -082 Top -081 Four Leg Base</p>	72	36	30	196	20.9	\$ 2058.00	<ul style="list-style-type: none"> • Sedona Cherry finish • Utility drawer with a pencil tray
				139	15.2	\$ 1540.00	
				57	5.7	\$ 518.00	



Conference Applications

For specifications, see individual collections.



FLEXSTEEL®
CONTRACT



DMI COLLECTION

Conference Tables VENEER COLLECTION





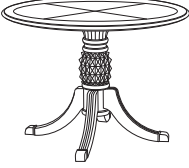

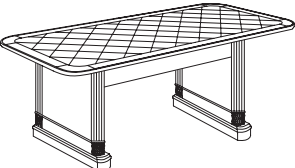
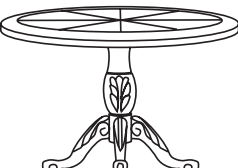
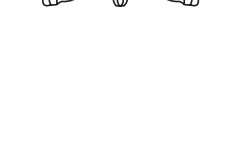
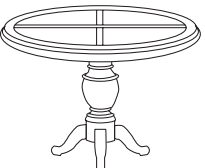
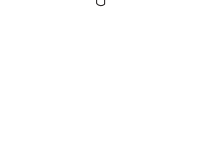
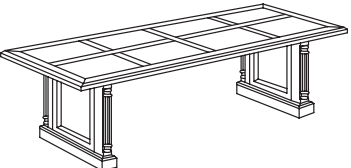
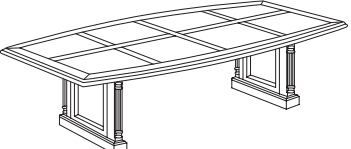

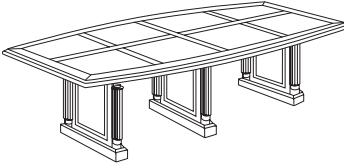
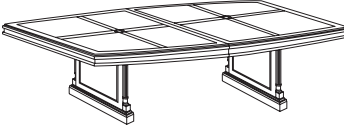

FLEXSTEEL®
CONTRACT

DMI COLLECTION

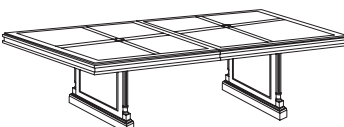
	Item Description	W"	D"	H"	Weight Lbs.	Cubic Ft.	List Price	Features
	Antigua 42" Round Conference Table							• West Indies Cherry finish
	7480-89	42	42	30	110	14.7	\$ 945.00	
	Consists of:							
	-011 Top	42	42		59	7.9	\$ 565.00	
	-002 Pedestal Base				51	6.8	\$ 380.00	
	Antigua 48" Round Conference Table							
	7480-90	48	48	30	120	15.1	\$ 1080.00	
	Consists of:							
	-016 Top	48	48		69	8.3	\$ 700.00	
	-002 Pedestal Base				51	6.8	\$ 380.00	
	Antigua 8' Conference Table							• West Indies Cherry finish
	7480-96	96	44	30	222	26.3	\$ 2660.00	
	Consists of:							
	-005 Top	96	44		148	19.1	\$ 1773.00	
	-001 Slab End Bases (set)				74	7.2	\$ 887.00	
	Balmoor 42" Round Conference Table							• Bordeaux Cherry finish
	7688-89	42	42	30	89	7.4	\$ 1892.00	
	Consists of:							
	-011 Top	42	42		65	4.9	\$ 1249.00	
	-002 Pedestal Base				24	2.5	\$ 643.00	
	Balmoor 48" Round Conference Table							
	7688-90	48	48	30	109	9.2	\$ 2044.00	
	Consists of:							
	-016 Top	48	48		85	6.7	\$ 1401.00	
	-002 Pedestal Base				24	2.5	\$ 643.00	
	Keswick 42" Round Queen Anne Conference Table							• English Cherry finish
	7990-89	42	42	30	78	20.3	\$ 1750.00	
	Consists of:							
	-011 Top				38	4.5	\$ 954.00	
	-002 Pedestal Base				40	15.8	\$ 796.00	
	Keswick 48" Round Queen Anne Conference Table							
	7990-90	48	48	30	84	21.4	\$ 2226.00	
	Consists of:							
	-016 Top				44	5.6	\$ 1430.00	
	-002 Pedestal Base				40	15.8	\$ 796.00	
	Keswick 8' Rectangular Conference Table							• English Cherry finish
	7990-94	96	48	30	248	20.7	\$ 2860.00	
	Consists of:							
	-004 Top				155	13.9	\$ 1906.00	
	-007 Slab End Bases (set)				93	6.8	\$ 954.00	
	Keswick 10' Boat Top Conference Table							• English Cherry finish
	7990-99	120	48	30	273	29.8	\$ 3975.00	
	Consists of:							
	-005 Top (2 pieces)				180	23.0	\$ 3021.00	
	-007 Slab End Bases (set)				93	6.8	\$ 954.00	

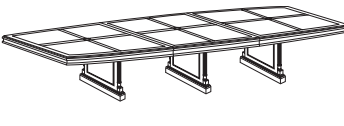

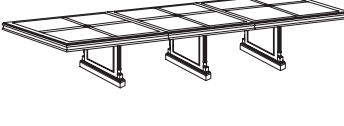
DMI COLLECTION





Item Description Model Number	W"	D"	H"	Weight Lbs.	Cubic Ft.	List Price	Features
 Keswick 12' Boat Top Conference Table 7990-97 Consists of: -006 Top (2 pieces) -007 Slab End Bases (set) -008 Slab Center Base	144	48	30	391	40.2	\$ 4833.00	<ul style="list-style-type: none"> English Cherry finish
				255	26.5	\$ 3339.00	
				93	6.8	\$ 954.00	
				43	6.9	\$ 540.00	
 Keswick 8' Boat Shaped Expandable Conference Table 7990-96EX Consists of: -9031 Left & Right Tops -9033 Base (2 needed) -9034 Rail Set for 9031	96	48	30	300	20.1	\$ 3065.00	<ul style="list-style-type: none"> English Cherry finish Grommet in each top section 7990-017 optional storage base available Grommets accommodate optional 0000-24, 0000-25 Mini Cove Power Center available
				150	12.1	\$ 1882.00	
				100	7.0	\$ 1010.00	
				50	1.0	\$ 173.00	
 Keswick 10' Boat Shaped Expandable Conference Table 7990-120EX Consists of: -9030 Left & Right Tops -9033 Base (2 needed) -9038 Rail Set for 10' table	120	48	30	330	23.4	\$ 3448.00	
				180	15.0	\$ 2244.00	
				100	7.0	\$ 1010.00	
				50	1.0	\$ 194.00	
 Keswick 8' Rectangular Expandable Conference Table 7990-96REX Consists of: -9028 Left & Right Tops -9033 Base (2 needed) -9034 Rail Set for 9028	96	48	30	300	20.1	\$ 2968.00	<ul style="list-style-type: none"> English Cherry finish Grommet in each top section 7990-017 optional storage base available Grommets accommodate optional 0000-24, 0000-25 Mini Cove Power Center available
				150	12.1	\$ 1785.00	
				100	7.0	\$ 1010.00	
				50	1.0	\$ 173.00	
 Keswick 10' Rectangular Expandable Conference Table 7990-120REX Consists of: -9029 Left & Right Tops -9033 Base (2 needed) -9038 Rail Set for 10' table	120	48	30	330	23.4	\$ 3295.00	
				180	15.0	\$ 2091.00	
				100	7.0	\$ 1010.00	
				50	1.0	\$ 194.00	
 Keswick 12' Boat Shaped Expandable Conference Table 7990-144EX Consists of: -9031 Left & Right Tops -9032 Center Top & Rails -9033 Base (3 needed) -9035 Rail Set for 9031 (2 needed)	144	48	30	475	35.7	\$ 4672.00	<ul style="list-style-type: none"> English Cherry finish Grommet in each top section 7990-017 optional storage base available Grommets accommodate optional 0000-24, 0000-25 Mini Cove Power Center available
				150	12.1	\$ 1882.00	
				75	10.7	\$ 969.00	
				150	10.5	\$ 1515.00	
 Keswick 14' Boat Shaped Expandable Conference Table 7990-168EX Consists of: -9030 Left & Right Tops -9032 Center Top & Rails -9033 Base (3 needed) -9037 Rail Set for 9030 (2 needed)	168	48	30	505	39.0	\$ 5086.00	
				180	15.0	\$ 2244.00	
				75	10.7	\$ 969.00	
				150	10.5	\$ 1515.00	
 Keswick 12' Rectangular Expandable Conference Table 7990-144REX Consists of: -9028 Left & Right Tops -9032 Center Top & Rails -9033 Base (3 needed) -9035 Rail Set for 9028 (2 needed)	144	48	30	475	35.7	\$ 4575.00	<ul style="list-style-type: none"> English Cherry finish Grommet in each top section 7990-017 optional storage base available Grommets accommodate optional 0000-24, 0000-25 Mini Cove Power Center available
				150	12.1	\$ 1785.00	
				75	10.7	\$ 969.00	
				150	10.5	\$ 1515.00	
 Keswick 14' Rectangular Expandable Conference Table 7990-168REX Consists of: -9029 Left & Right Tops -9032 Center Top & Rails -9033 Base (3 needed) -9037 Rail Set for 9029 (2 needed)	168	48	30	505	39.0	\$ 4933.00	
				180	15.0	\$ 2091.00	
				75	10.7	\$ 969.00	
				150	10.5	\$ 1515.00	

Conference Tables VENEER COLLECTION

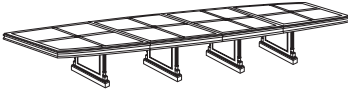

FLEXSTEEL®
CONTRACT

DMI COLLECTION

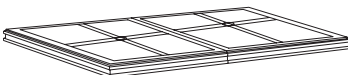
Item Description	Weight	Cubic	List	
Model Number	W" D" H"	Lbs.	Ft.	Price Features
Keswick 16' Boat Shaped Expandable Conference Table				
7990-192EX	192 48 30	600	49.9	\$ 6146.00
Consists of:				
-9031 Left & Right Tops	48 48	150	12.1	\$ 1882.00
-9032 Center Top & Rails (2 needed)	48 48	150	21.4	\$ 1938.00
-9033 Base (4 needed)	28 5.25 29	200	14.0	\$ 2020.00
-9035 Rail Set for 9031 (2 needed)	48	100	2.4	\$ 306.00
				<ul style="list-style-type: none"> • English Cherry finish • Grommet in each top section • 7990-017 optional storage base available • Grommets accommodate optional 0000-24, 0000-25 Mini Cove Power Center available
				
Keswick 18' Boat Shaped Expandable Conference Table				
7990-216EX	216 48 30	630	53.2	\$ 6560.00
Consists of:				
-9030 Left & Right Tops	60 48	180	15.0	\$ 2244.00
-9032 Center Top & Rails (2 needed)	48 48	150	21.4	\$ 1938.00
-9033 Base (4 needed)	28 5.25 29	200	14.0	\$ 2020.00
-9037 Rail Set for 9030 (2 needed)	60.5	100	2.8	\$ 358.00
Keswick 16' Rectangular Expandable Conference Table				
7990-192REX	192 48 30	600	49.9	\$ 6049.00
Consists of:				
-9028 Left & Right Tops	48 48	150	12.1	\$ 1785.00
-9032 Center Top & Rails (2 needed)	48 48	150	21.4	\$ 1938.00
-9033 Base (4 needed)	28 5.25 29	200	14.0	\$ 2020.00
-9035 Rail Set for 9028 (2 needed)	48	100	2.4	\$ 306.00
				<ul style="list-style-type: none"> • English Cherry finish • Grommet in each top section • 7990-017 optional storage base available • Grommets accommodate optional 0000-24, 0000-25 Mini Cove Power Center available
				
Keswick 18' Rectangular Expandable Conference Table				
7990-216REX	216 48 30	505	39.0	\$ 6407.00
Consists of:				
-9029 Left & Right Tops	60 48	180	15.0	\$ 2091.00
-9032 Center Top & Rails (2 needed)	48 48	150	21.4	\$ 1938.00
-9033 Base (4 needed)	28 5.25 29	200	14.0	\$ 2020.00
-9037 Rail Set for 9029 (2 needed)	60.5	100	2.8	\$ 358.00
Keswick 20' Boat Shaped Expandable Conference Table				
7990-240EX	240 48 30	725	64.1	\$ 7620.00
Consists of:				
-9031 Left & Right Tops	48 48	150	12.1	\$ 1882.00
-9032 Center Top & Rails (3 needed)	48 48	225	32.1	\$ 2907.00
-9033 Base (5 needed)	28 5.25 29	250	17.5	\$ 2525.00
-9035 Rail Set for 9031 (2 needed)	48	100	2.4	\$ 306.00
				<ul style="list-style-type: none"> • English Cherry finish • Grommet in each top section • 7990-017 optional storage base available • Grommets accommodate optional 0000-24, 0000-25 Mini Cove Power Center available
				
Keswick 22' Boat Shaped Expandable Conference Table				
7990-264EX	264 48 30	755	67.4	\$ 8034.00
Consists of:				
-9030 Left & Right Tops	60 48	180	15.0	\$ 2244.00
-9032 Center Top & Rails (3 needed)	48 48	225	32.1	\$ 2907.00
-9033 Base (5 needed)	28 5.25 29	250	17.5	\$ 2525.00
-9037 Rail Set for 9030 (2 needed)	60.5	100	2.8	\$ 358.00
Keswick 20' Rectangular Expandable Conference Table				
7990-240REX	240 48 30	725	64.1	\$ 7523.00
Consists of:				
-9028 Left & Right Tops	48 48	150	12.1	\$ 1785.00
-9032 Center Top & Rails (3 needed)	48 48	225	32.1	\$ 2907.00
-9033 Base (5 needed)	28 5.25 29	250	17.5	\$ 2525.00
-9035 Rail Set for 9028 (2 needed)	48	100	2.4	\$ 306.00
				<ul style="list-style-type: none"> • English Cherry finish • Grommet in each top section • 7990-017 optional storage base available • Grommets accommodate optional 0000-24, 0000-25 Mini Cove Power Center available
				
Keswick 22' Rectangular Expandable Conference Table				
7990-264REX	264 48 30	755	67.4	\$ 7881.00
Consists of:				
-9029 Left & Right Tops	60 48	180	15.0	\$ 2091.00
-9032 Center Top & Rails (3 needed)	48 48	225	32.1	\$ 2907.00
-9033 Base (5 needed)	28 5.25 29	250	17.5	\$ 2525.00
-9037 Rail Set for 9029 (2 needed)	60.5	100	2.8	\$ 358.00
Keswick 48" Left and Right Section Rectangular Expandable Table Tops				
7990-9028	96 48	150	12.1	\$ 1785.00
Keswick 60" Left and Right Section Rectangular Expandable Table Tops				
7990-9029	120 48	180	15.0	\$ 2091.00
				<ul style="list-style-type: none"> • English Cherry finish • Individual component • Grommet in each top section • 7990-9028 includes two 48" section tops • 7990-9029 includes two 60" section tops • Grommets accommodate optional 0000-24, 0000-25 Mini Cove Power Center available
				

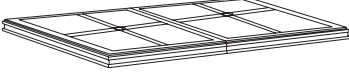
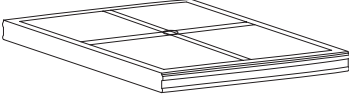
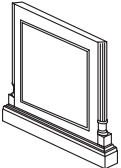
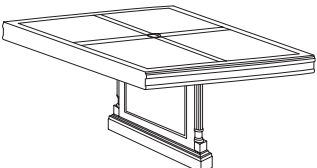
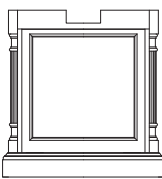
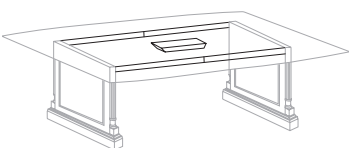
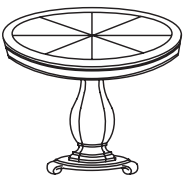
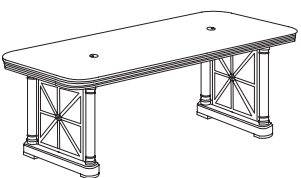
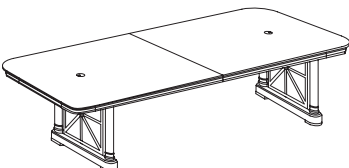

DMI COLLECTION

	Item Description	W"	D"	H"	Weight Lbs.	Cubic Ft.	List Price	Features
	Model Number							
	Keswick 60" Left and Right Section Boat Shaped Expandable Table Tops	120	48		180	15.0	\$ 2244.00	<ul style="list-style-type: none"> English Cherry finish Individual component Grommet in each top section 7990-9030 includes two 60" section tops 7990-9031 includes two 48" section tops Grommets accommodate optional 0000-24, 0000-25 Mini Cove Power Center available
	Keswick 48" Left and Right Section Boat Shaped Expandable Table Tops	96	48		150	12.1	\$ 1882.00	
	Keswick 48" Center Section Expandable Conference Table Top with 44" Rails	48	48		75	10.7	\$ 969.00	<ul style="list-style-type: none"> English Cherry finish Individual component Grommet in top section Grommet accommodates optional 0000-24, 0000-25 Mini Cove Power Center available
	Keswick Expandable Conference Table Base	28	5.25	29	50	3.5	\$ 505.00	<ul style="list-style-type: none"> English Cherry finish Individual component
	Keswick 48" Center Section Top and Base	48	48	30	125	14.2	\$ 1474.00	<ul style="list-style-type: none"> English Cherry finish Grommet in top Grommet accommodates optional 0000-24, 0000-25 Mini Cove Power Center available
	Consists of:							
	-9032 Center Top & Rails	48	48		75	10.7	\$ 969.00	
	-9033 Base	28	5.25	29	50	3.5	\$ 505.00	
	Keswick Expandable Conference Table Storage Base	26.5	4.75	29.5	40	5.5	\$ 550.00	<ul style="list-style-type: none"> English Cherry finish Individual component Hidden storage cabinet measures 22"W x 3.5"D x 20"H Must be positioned at the end of the table Cable accessible
	Keswick Expandable Conference Table Storage Base							<ul style="list-style-type: none"> English Cherry finish Individual components 7990-9034 rail set for 8' expandable tables 7990-9035 rail set for left and right 48" tops 7990-9037 rail set for left and right 60" tops 7990-9038 rail set for 10' expandable tables
	7990-9034	52			50	1.0	\$ 173.00	
	7990-9035	60.5			50	1.2	\$ 153.00	
	7990-9037	60.5			50	1.4	\$ 179.00	
	7990-9038	76			50	1.4	\$ 194.00	
	Rue De Lyon 42" Round Conference Table	42	42	30	110	14.7	\$ 1394.00	<ul style="list-style-type: none"> Ruby Cabernet finish
	7684-89							
	Consists of:							
	-011 Top	42	42		59	7.9	\$ 902.00	
	-002 Pedestal Base				51	6.8	\$ 492.00	
	Rue De Lyon 8' Rectangular Conference Table	96	44	30	218	27.4	\$ 2377.00	<ul style="list-style-type: none"> Ruby Cabernet finish Two grommets in top
	7684-96A							
	Consists of:							
	-005A Top	96	44		149	20.1	\$ 1586.00	
	-001A Slab End Bases (set)				69	7.3	\$ 791.00	
	Rue De Lyon 10' Rectangular Conference Table	120	44	30	324	25.1	\$ 2542.00	<ul style="list-style-type: none"> Ruby Cabernet finish Grommet in each top section
	7684-120							
	Consists of:							
	-015 Top (2 pieces)	120	44	4.5	255	17.8	\$ 1751.00	
	-001A Slab End Bases (set)				69	7.3	\$ 791.00	

Conference Tables VENEER COLLECTION





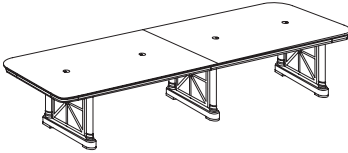
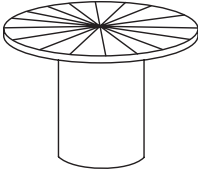
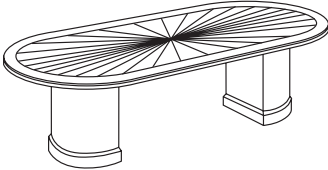
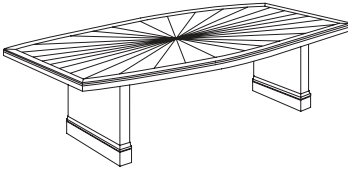
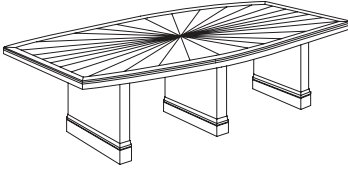
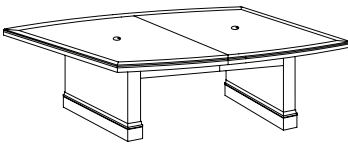

FLEXSTEEL®
CONTRACT

DMI COLLECTION

Item Description	Weight	Cubic	List	
Model Number	W" D" H"	Lbs.	Ft.	Price Features
 <p>Rue De Lyon 12' Rectangular Conference Table 7684-144</p> <p>Consists of:</p> <ul style="list-style-type: none"> -006 Top (2 pieces) -001A Slab End Bases (set) -007 Center Slab Base 	436	33.2	\$ 3156.00	<ul style="list-style-type: none"> • Ruby Cabernet finish • Two grommets in each top section
	144 44 30			
	144 44 4.5	335	21.1	\$ 1927.00
		69	7.3	\$ 791.00
		32	4.8	\$ 438.00
 <p>Belmont 42" Round Conference Table 713_-89</p> <p>Consists of:</p> <ul style="list-style-type: none"> -011 Top -005 Cylinder Base 	125	12.6	\$ 1897.00	<ul style="list-style-type: none"> • 7130 Executive Cherry finish • 7132 Brown Cherry finish
	42 42 30			
	42 42	40	4.4	\$ 1206.00
	20 20	85	8.2	\$ 691.00
<p>Belmont 48" Round Conference Table 713_-90</p> <p>Consists of:</p> <ul style="list-style-type: none"> -016 Top -005 Cylinder Base 	135	13.8	\$ 2415.00	
	48 48 30			
	48 48	50	5.6	\$ 1724.00
	20 20	85	8.2	\$ 691.00
 <p>Belmont 8' Race Track Conference Table 713_-96</p> <p>Consists of:</p> <ul style="list-style-type: none"> -961 Top -962 Bases (set) 	276	26.3	\$ 4137.00	<ul style="list-style-type: none"> • 7130 Executive Cherry finish • 7132 Brown Cherry finish
	96 48 30			
	96 48	186	15.2	\$ 2758.00
		90	11.1	\$ 1379.00
 <p>Belmont 10' Boat Shaped Conference Table 713_-97</p> <p>Consists of:</p> <ul style="list-style-type: none"> -971 Top (2 piece) -972 Slab End Bases (set) 	326	27.0	\$ 4307.00	<ul style="list-style-type: none"> • 7130 Executive Cherry finish • 7132 Brown Cherry finish • Table top comes in two pieces for ease in installation
	120 48 30			
	120 48	235	18.9	\$ 3101.00
		91	8.1	\$ 1206.00
 <p>Belmont 12' Boat Shaped Conference Table 7130-98</p> <p>Consists of:</p> <ul style="list-style-type: none"> -981 Top (2 piece) -982 Slab End Bases (3 piece set) 	415	31.5	\$ 5242.00	<ul style="list-style-type: none"> • Available in 7130 Executive Cherry finish only • Table top comes in two pieces for ease in installation
	144 48 30			
	144 48	280	19.9	\$ 3448.00
		135	11.6	\$ 1794.00
 <p>Belmont 8' Boat Shaped Expandable Conference Table 713_-96EX</p> <p>Consists of:</p> <ul style="list-style-type: none"> -9031 Left & Right Tops -9033 Base (2 needed) -9034 Rail Set 	300	25.4	\$ 3104.00	<ul style="list-style-type: none"> • 7130 Executive Cherry finish • 7132 Brown Cherry finish • Grommet in each top section • 713_-113 optional storage base available • Grommets accommodate optional 0000-24, 0000-25 Mini Cove Power Center available
	96 48 30			
	48 48	150	11.4	\$ 1973.00
	28 5.25 29	100	12.4	\$ 960.00
	52	50	1.6	\$ 171.00
<p>Belmont 10' Boat Shaped Expandable Conference Table 713_-120EX</p> <p>Consists of:</p> <ul style="list-style-type: none"> -9030 Left & Right Tops -9033 Base (2 needed) -9038 Rail Set 	330	31.9	\$ 3974.00	
	120 48 30			
	60 48	180	17.2	\$ 2820.00
	28 5.25 29	100	12.4	\$ 960.00
	76	50	2.3	\$ 194.00

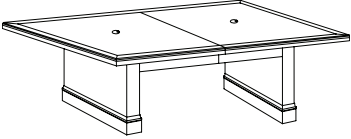
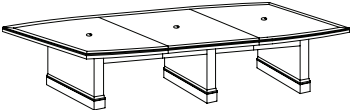

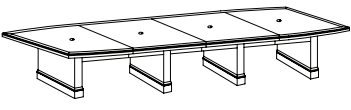
DMI COLLECTION

Item Description Model Number	W"	D"	H"	Weight Lbs.	Cubic Ft.	List Price	List Features	
 Belmont 8' Rectangular Expandable Conference Table 713_-96REX Consists of:	96	48	30	300	25.4	\$ 3014.00	<ul style="list-style-type: none"> • 7130 Executive Cherry finish • 7132 Brown Cherry finish • Grommet in each top section • 713_-113 optional storage base available • Grommets accommodate optional 0000-24, 0000-25 Mini Cove Power Center available 	
	-9028 Left & Right Tops	48	48	150	11.4	\$ 1883.00		
	-9033 Base (2 needed)	28	5.25	29	100	12.4		\$ 960.00
	-9034 Rail Set	52			50	1.6		\$ 171.00
 Belmont 10' Rectangular Expandable Conference Table 713_-120REX Consists of:	120	48	30	330	31.9	\$ 3760.00		
	-9029 Left & Right Tops	60	48	180	17.2	\$ 2606.00		
	-9033 Base (2 needed)	28	5.25	29	100	12.4		\$ 960.00
	-9038 Rail Set	76			50	2.3		\$ 194.00
 Belmont 12' Boat Shaped Expandable Conference Table 713_-144EX Consists of:	144	48	30	475	41.6	\$ 4944.00	<ul style="list-style-type: none"> • 7130 Executive Cherry finish • 7132 Brown Cherry finish • Grommet in each top section • 713_-113 optional storage base available • Grommets accommodate optional 0000-24, 0000-25 Mini Cove Power Center available 	
	-9031 Left & Right Tops	48	48	150	11.4	\$ 1973.00		
	-9032 Center Top & Rails	48	48	75	8.6	\$ 1217.00		
	-9033 Base (3 needed)	28	5.25	29	150	18.6		\$ 1440.00
	-9035 Rail Set (2 needed)	48			100	3.0		\$ 314.00
 Belmont 14' Boat Shaped Expandable Conference Table 713_-168EX Consists of:	168	48	30	505	48.2	\$ 5815.00		
	-9030 Left & Right Tops	60	48	180	17.2	\$ 2820.00		
	-9032 Center Top & Rails	48	48	75	8.6	\$ 1217.00		
	-9033 Base (3 needed)	28	5.25	29	150	18.6		\$ 1440.00
	-9037 Rail Set (2 needed)	60.5			100	3.8		\$ 338.00
 Belmont 12' Rectangular Expandable Conference Table 713_-144REX Consists of:	144	48	30	475	41.6	\$ 4854.00	<ul style="list-style-type: none"> • 7130 Executive Cherry finish • 7132 Brown Cherry finish • Grommet in each top section • 713_-113 optional storage base available • Grommets accommodate optional 0000-24, 0000-25 Mini Cove Power Center available 	
	-9028 Left & Right Tops	48	48	150	11.4	\$ 1883.00		
	-9032 Center Top & Rails	48	48	75	8.6	\$ 1217.00		
	-9033 Base (3 needed)	28	5.25	29	150	18.6		\$ 1440.00
	-9035 Rail Set (2 needed)	48			100	3.0		\$ 314.00
 Belmont 14' Rectangular Expandable Conference Table 713_-168REX Consists of:	168	48	30	505	48.2	\$ 5601.00		
	-9029 Left & Right Tops	60	48	180	17.2	\$ 2606.00		
	-9032 Center Top & Rails	48	48	75	8.6	\$ 1217.00		
	-9033 Base (3 needed)	28	5.25	29	150	18.6		\$ 1440.00
	-9037 Rail Set (2 needed)	60.5			100	3.8		\$ 338.00
 Belmont 16' Boat Shaped Expandable Conference Table 713_-192EX Consists of:	192	48	30	600	56.4	\$ 6641.00	<ul style="list-style-type: none"> • 7130 Executive Cherry finish • 7132 Brown Cherry finish • Grommet in each top section • 713_-113 optional storage base available • Grommets accommodate optional 0000-24, 0000-25 Mini Cove Power Center available 	
	-9031 Left & Right Tops	48	48	150	11.4	\$ 1973.00		
	-9032 Center Top & Rails (2 needed)	48	48	150	17.2	\$ 2434.00		
	-9033 Base (4 needed)	28	5.25	29	200	24.8		\$ 1920.00
	-9035 Rail Set (2 needed)	48			100	3.0		\$ 314.00
 Belmont 18' Boat Shaped Expandable Conference Table 713_-216EX Consists of:	216	48	30	630	63.0	\$ 7512.00		
	-9030 Left & Right Tops	60	48	180	17.2	\$ 2820.00		
	-9032 Center Top & Rails (2 needed)	48	48	150	17.2	\$ 2434.00		
	-9033 Base (4 needed)	28	5.25	29	200	24.8		\$ 1920.00
	-9037 Rail Set (2 needed)	60.5			100	3.8		\$ 338.00

Conference Tables VENEER COLLECTION







FLEXSTEEL®
CONTRACT

DMI COLLECTION

Item Description	W"	D"	H"	Weight Lbs.	Cubic Ft.	List Price	Features
Belmont 16' Rectangular Expandable Conference Table 713_-192REX	192	48	30	600	56.4	\$ 6551.00	<ul style="list-style-type: none"> • 7130 Executive Cherry finish • 7132 Brown Cherry finish • Grommet in each top section • 713_-113 optional storage base available • Grommets accommodate optional 0000-24, 0000-25 Mini Cove Power Center available
Consists of:							
-9028 Left & Right Tops	48	48		150	11.4	\$ 1883.00	
-9032 Center Top & Rails (2 needed)	48	48		150	17.2	\$ 2434.00	
-9033 Base (4 needed)	28	5.25	29	200	24.8	\$ 1920.00	
-9035 Rail Set (2 needed)	48			100	3.0	\$ 314.00	
Belmont 18' Rectangular Expandable Conference Table 713_-216REX	216	48	30	630	48.2	\$ 7298.00	
Consists of:							
-9029 Left & Right Tops	60	48		180	17.2	\$ 2606.00	
-9032 Center Top & Rails (2 needed)	48	48		150	17.2	\$ 2434.00	
-9033 Base (4 needed)	28	5.25	29	200	24.8	\$ 1920.00	
-9037 Rail Set (2 needed)	60.5			100	3.8	\$ 338.00	
Belmont 20' Boat Shaped Expandable Conference Table 713_-240EX	240	48	30	725	71.2	\$ 8338.00	<ul style="list-style-type: none"> • 7130 Executive Cherry finish • 7132 Brown Cherry finish • Grommet in each top section • 713_-113 optional storage base available • Grommets accommodate optional 0000-24, 0000-25 Mini Cove Power Center available
Consists of:							
-9031 Left & Right Tops	48	48		150	11.4	\$ 1973.00	
-9032 Center Top & Rails (3 needed)	48	48		225	25.8	\$ 3651.00	
-9033 Base (5 needed)	28	5.25	29	250	31.0	\$ 2400.00	
-9035 Rail Set (2 needed)	48			100	3.0	\$ 314.00	
Belmont 22' Boat Shaped Expandable Conference Table 713_-264EX	264	48	30	755	77.8	\$ 9209.00	
Consists of:							
-9030 Left & Right Tops	60	48		180	17.2	\$ 2820.00	
-9032 Center Top & Rails (3 needed)	48	48		225	25.8	\$ 3651.00	
-9033 Base (5 needed)	28	5.25	29	250	31.0	\$ 2400.00	
-9037 Rail Set (2 needed)	60.5			100	3.8	\$ 338.00	
Belmont 20' Rectangular Expandable Conference Table 713_-240REX	240	48	30	725	71.2	\$ 8248.00	<ul style="list-style-type: none"> • 7130 Executive Cherry finish • 7132 Brown Cherry finish • Grommet in each top section • 713_-113 optional storage base available • Grommets accommodate optional 0000-24, 0000-25 Mini Cove Power Center available
Consists of:							
-9028 Left & Right Tops	48	48		150	11.4	\$ 1883.00	
-9032 Center Top & Rails (3 needed)	48	48		225	25.8	\$ 3651.00	
-9033 Base (5 needed)	28	5.25	29	250	31.0	\$ 2400.00	
-9035 Rail Set (2 needed)	48			100	3.0	\$ 314.00	
Belmont 22' Rectangular Expandable Conference Table 713_-264REX	264	48	30	755	77.8	\$ 8995.00	
Consists of:							
-9029 Left & Right Tops	60	48		180	17.2	\$ 2606.00	
-9032 Center Top & Rails (3 needed)	48	48		225	25.8	\$ 3651.00	
-9033 Base (5 needed)	28	5.25	29	250	31.0	\$ 2400.00	
-9037 Rail Set (2 needed)	60.5			100	3.8	\$ 338.00	
Belmont 48" Left & Right Section Rectangular Expandable Table Top 713_-9028	96	48		150	11.4	\$ 1883.00	<ul style="list-style-type: none"> • 7130 Executive Cherry finish • 7132 Brown Cherry finish • Two piece tops • Grommet in each top section • Grommets accommodate optional 0000-24, 0000-25 Mini Cove Power Center available
Belmont 60" Left & Right Section Rectangular Expandable Table Top 713_-9029	120	48		180	17.2	\$ 2606.00	
Belmont 60" Left & Right Section Boat Shaped Expandable Table Top 713_-9030	120	48		180	17.2	\$ 2820.00	<ul style="list-style-type: none"> • 7130 Executive Cherry finish • 7132 Brown Cherry finish • Two piece tops • Grommet in each top section • Grommets accommodate optional 0000-24, 0000-25 Mini Cove Power Center available
Belmont 48" Left & Right Section Boat Shaped Expandable Table Top 713_-9031	96	48		150	11.4	\$ 1973.00	
Belmont 48" Center Section Expandable Conference Table Top with 44" Rails 713_-9032	48	48		75	8.6	\$ 1217.00	<ul style="list-style-type: none"> • 7130 Executive Cherry finish • 7132 Brown Cherry finish • Rails include wire management tray for top • Grommet in top • Grommet accommodates optional 0000-24, 0000-25 Mini Cove Power Center available

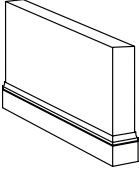
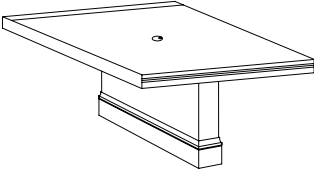
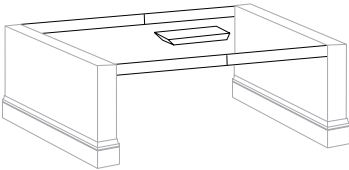
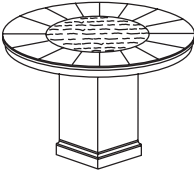

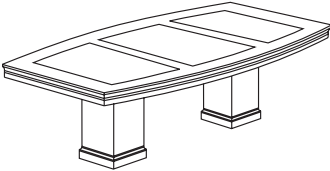
DMI COLLECTION

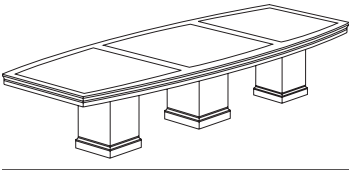
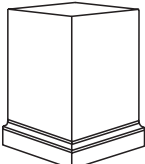

Item Description	Model Number	W"	D"	H"	Weight Lbs.	Cubic Ft.	List Price	Features
	Belmont Expandable Conference Table Base							
	713_-9033	29.5	5.5	29	50	6.2	\$ 480.00	<ul style="list-style-type: none"> • 7130 Executive Cherry finish • 7132 Brown Cherry finish • 713_-113 must be placed at the end of the table
	Belmont Expandable Conference Table Storage Base							
	713_-113	29.5	5.5	29	48	6.3	\$ 529.00	
	Belmont 48" Center Section Top and Base							
	713_-903233	48	48	30	125	14.8	\$ 1697.00	<ul style="list-style-type: none"> • 7130 Executive Cherry finish • 7132 Brown Cherry finish • Grommet in top • Grommet accommodates optional 0000-24, 0000-25 Mini Cove Power Center available
	Consists of:							
	-9032 Center Top & Rails	48	48		75	8.6	\$ 1217.00	
	-9033 Base	29.5	5.5	29	50	6.2	\$ 480.00	
	Belmont Expandable Conference Table Rail Sets							
	713_-9034	52	.75	4	50	1.6	\$ 171.00	<ul style="list-style-type: none"> • 7130 Executive Cherry finish • 7132 Brown Cherry finish
	713_-9035	48	.75	4	50	1.5	\$ 157.00	<ul style="list-style-type: none"> • Includes wire management tray for top
	713_-9037	60.5	.75	4	50	1.9	\$ 169.00	<ul style="list-style-type: none"> • 713_-9034 rail set for -96EX, -96REX
	713_-9038	76	.75	4	50	2.3	\$ 194.00	<ul style="list-style-type: none"> • 713_-9037 rail set for -9029, -9030 • 713_-9038 rail set for -120EX, -120REX
	Del Mar 42" Round Conference Table							
	7302-89	42	42	30	150	15.8	\$ 1997.00	<ul style="list-style-type: none"> • Sedona Cherry finish • Optional storage base available
	Consists of:							
	-011 Top	42	42		88	6.5	\$ 1358.00	
	-003 Square Ped Base	18	18		62	9.3	\$ 639.00	
	Del Mar 48" Round Conference Table							
	7302-90	48	48	30	166	18.1	\$ 2553.00	
	Consists of:							
	-016 Top	48	48		104	8.8	\$ 1914.00	
	-003 Square Ped Base	18	18		62	9.3	\$ 639.00	
	Del Mar 8' Boat Shaped Conference Table							
	7302-96	96	42	30	331	38.9	\$ 3231.00	<ul style="list-style-type: none"> • Sedona Cherry finish • Optional storage base available
	Consists of:							
	-004 Top	96	42		207	20.3	\$ 1953.00	
	-003 Square Ped Base (2 needed)	18	18		124	18.6	\$ 1278.00	
	Del Mar 10' Boat Shaped Conference Table							
	7302-120	120	48	30	384	40.2	\$ 3711.00	
	Consists of:							
	-005 Top (2 piece)	120	48		260	21.6	\$ 2433.00	
	-003 Square Ped Base (2 needed)	18	18		124	18.6	\$ 1278.00	
	Del Mar 12' Boat Shaped Conference Table							
	7302-144	144	48	30	492	53.2	\$ 5146.00	<ul style="list-style-type: none"> • Sedona Cherry finish • Optional storage base available
	Consists of:							
	-006 Top (2 piece)	144	48		306	25.3	\$ 3229.00	
	-003 Square Ped Base (3 needed)	18	18		186	27.9	\$ 1917.00	
	Del Mar Optional Storage Base							
	7302-013	18.5	18.5	29.25	62	8.1	\$ 695.00	<ul style="list-style-type: none"> • Sedona Cherry finish • Optional base for use on conference tables • Hidden storage cabinet measures 13.25 x 13.25 x 22.5 • Removable shelf

Conference Tables LAMINATE COLLECTION

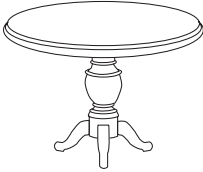

FLEXSTEEL®
CONTRACT

DMI COLLECTION

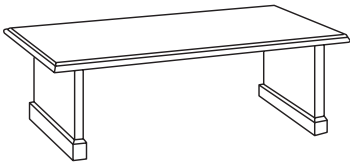
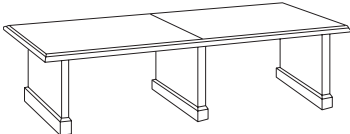
Item Description	Weight	Cubic	List	Features	
Model Number	W" D" H"	Lbs.	Ft.	Price	
	Keswick 42" Round Queen Anne Conference Table with HPL Top				
	7990-89HPL	42 42 30	78	20.3	\$ 1750.00
Consists of:					
-011 HPL Top		38	4.5	\$ 954.00	
-002 Pedestal Base		40	15.8	\$ 796.00	
Keswick 48" Round Queen Anne Conference Table with HPL Top					
7990-90HPL	48 48 30	84	21.4	\$ 2226.00	
Consists of:					
-016 HPL Top		44	6.5	\$ 1430.00	
-002 Pedestal Base		40	15.8	\$ 796.00	
	Governors 42" Round Queen Anne Conference Table				
	7350-89	42 42 30	79	14.3	\$ 1240.00
Consists of:					
-011 HPL Top	42 42	45	3.4	\$ 812.00	
-002 Pedestal Base		34	10.9	\$ 428.00	
Governors 48" Round Queen Anne Conference Table					
7350-90	48 48 30	96	15.2	\$ 1453.00	
Consists of:					
-016 HPL Top	48 48	62	4.3	\$ 1025.00	
-002 Pedestal Base		34	10.9	\$ 428.00	
	Governors 6' Rectangular Conference Table with Slab Bases				
	7350-93	72 36 30	165	11.7	\$ 1494.00
Consists of:					
-019 HPL Top (2 pieces)	120 46	175	11.2	\$ 2028.00	
-001 Slab End Bases (set)		65	4.1	\$ 321.00	
-029 Apron Support Rails		15	1.2	\$ 105.00	
Governors 8' Rectangular Conference Table with Slab Bases					
7350-94	96 44 30	220	18.0	\$ 1758.00	
Governors 10' Rectangular Conference Table with Slab Bases					
7350-95	120 46 30	255	16.5	\$ 2454.00	
Consists of:					
-019 HPL Top (2 pieces)	120 46	175	11.2	\$ 2028.00	
-001 Slab End Bases (set)		65	4.1	\$ 321.00	
-029 Apron Support Rails		15	1.2	\$ 105.00	
	Governors 12' Rectangular Conference Table with Slab Bases				
	7350-99	144 46 30	438	32.4	\$ 4484.00
Consists of:					
-006 HPL Top (2 pieces)	144 46	341	26.2	\$ 3947.00	
-008 Center Slab Base		32	2.1	\$ 216.00	
-001 Slab End Bases (set)		65	4.1	\$ 321.00	

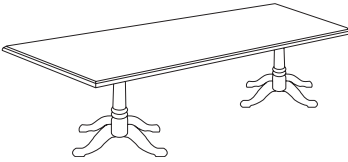

DMI COLLECTION

Item Description	Model Number	W"	D"	H"	Weight Lbs.	Cubic Ft.	List Price	Features	
 <p>Governors 6' Rectangular Conference Table with Queen Anne Base 7350-96</p> <p>Consists of:</p> <p>-017 HPL Top</p> <p>-002 Pedestal Base (2 needed)</p>		72	36	30	153	29.1	\$	2029.00	<ul style="list-style-type: none"> • Engraved Executive Mahogany finish • HPL top with solid wood veneer edges
		72	36		85	7.3	\$	1173.00	
					65	21.8	\$	856.00	
<p>Governors 8' Rectangular Conference Table with Queen Anne Base 7350-97</p> <p>Consists of:</p> <p>-018 HPL Top</p> <p>-002 Pedestal Base (2 needed)</p>		96	44	30	208	33.2	\$	2244.00	
		96	44		140	11.4	\$	1388.00	
					65	21.8	\$	856.00	
<p>Governors 10' Rectangular Conference Table with Queen Anne Base 7350-98</p> <p>Consists of:</p> <p>-019 HPL Top (2 pieces)</p> <p>-002 Pedestal Base (2 needed)</p>		120	46	30	243	33.0	\$	2884.00	
		120	46		175	11.2	\$	2028.00	
					65	21.8	\$	856.00	

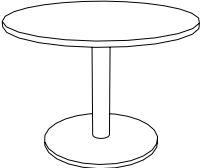
 <p>Causeway 42" Round Conference Table 704_-011</p>		42	42	1.25	57	2.1	\$	252.00	<ul style="list-style-type: none"> • 7040 Mocha finish • 7041 Honey Maple finish • 7042 Mahogany finish • 7043 White finish • 7047 Walnut finish • 42" diameter top • 28" diameter base with 4" diameter aluminum finished post
		28	28	27.5	86	13.1	\$	804.00	

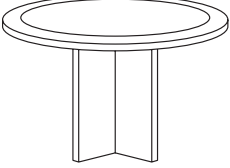
 <p>Fairplex 36" Round Conference Table 700_-725</p>		36	36	29	65	3.2	\$	335.00	<ul style="list-style-type: none"> • 7003 Grey finish • 7004 Mocha finish • 7005 Cognac Cherry finish • 7006 Mahogany finish • 7007 Walnut finish
<p>Fairplex 42" Round Conference Table 700_-726</p>		42	42	29	95	6.3	\$	361.00	
<p>Fairplex 47" Round Conference Table 700_-721</p>		47	47	29	109	7.9	\$	432.00	

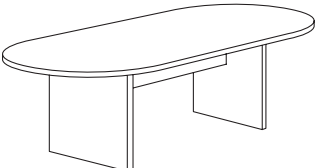
 <p>Fairplex 6' Racetrack Conference Table 700_-720</p>		71	35	29	139	6.7	\$	470.00	<ul style="list-style-type: none"> • 7003 Grey finish • 7004 Mocha finish • 7005 Cognac Cherry finish • 7006 Mahogany finish • 7007 Walnut finish
<p>Fairplex 8' Racetrack Conference Table 700_-723</p>		95	42	29	189	10.8	\$	663.00	

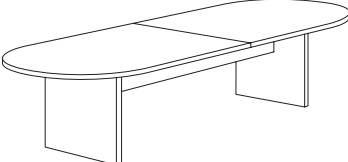

 <p>Fairplex 10' Racetrack Conference Table 700_-727</p> <p>Consists of:</p> <p>-728 Two Piece Top with Bases</p> <p>-729 120" Stretcher</p>		120	48	29	246	11.3	\$	921.00	<ul style="list-style-type: none"> • 7003 Grey finish • 7004 Mocha finish • 7005 Cognac Cherry finish • 7006 Mahogany finish • 7007 Walnut finish
		120	48		222	10.0	\$	753.00	
					24	1.3	\$	168.00	

Conference Tables LAMINATE COLLECTION

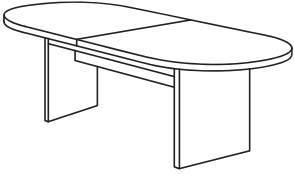
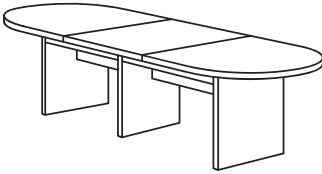
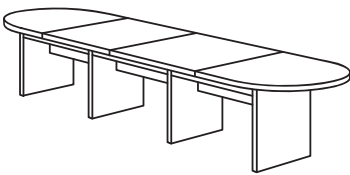
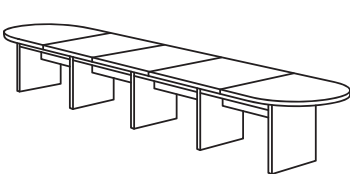
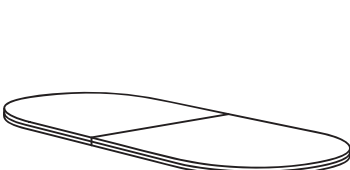

FLEXSTEEL®
CONTRACT

DMI COLLECTION

Item Description Model Number	W"	D"	H"	Weight Lbs.	Cubic Ft.	List		
						Price	Features	
 Fairplex 8' Racetrack Expandable Conference Table 700_-96EX Consists of:				235	8.4	\$	893.00	<ul style="list-style-type: none"> • 7003 Grey finish • 7004 Mocha finish • 7005 Cognac Cherry finish • 7006 Mahogany finish • 7007 Walnut finish
	-9031 Left & Right Top	48	48	150	5.2	\$	541.00	
	-9033 Base (2 needed)			60	2.2	\$	238.00	
	-9034 48" Rail Set			25	1.0	\$	114.00	
 Fairplex 10' Racetrack Expandable Conference Table 700_-120EX Consists of:				270	11.0	\$	1091.00	
	-9030 Left & Right Top	60	48	180	6.5	\$	688.00	
	-9033 Base (2 needed)			60	2.2	\$	238.00	
	-9038 72" Rail Set for 10' Table			30	2.3	\$	165.00	
 Fairplex 12' Racetrack Expandable Conference Table 700_-144EX Consists of:				385	15.7	\$	1563.00	<ul style="list-style-type: none"> • 7003 Grey finish • 7004 Mocha finish • 7005 Cognac Cherry finish • 7006 Mahogany finish • 7007 Walnut finish
	-9031 Left & Right Top	48	48	150	5.2	\$	541.00	
	-9032 Center Top & Rails	48	48	95	5.2	\$	437.00	
	-9033 Base (3 needed)			90	3.3	\$	357.00	
-9034 48" Rail Set (2 needed)			50	2.0	\$	228.00		
 Fairplex 14' Racetrack Expandable Conference Table 700_-168EX Consists of:				421	17.4	\$	1776.00	
	-9030 Left & Right Top	60	48	180	6.5	\$	688.00	
	-9032 Center Top & Rails	48	48	95	5.2	\$	437.00	
	-9033 Base (3 needed)			90	3.3	\$	357.00	
-9037 60" Rail Set (2 needed)			56	2.4	\$	294.00		
 Fairplex 16' Racetrack Expandable Conference Table 700_-192EX Consists of:				510	22.0	\$	2119.00	<ul style="list-style-type: none"> • 7003 Grey finish • 7004 Mocha finish • 7005 Cognac Cherry finish • 7006 Mahogany finish • 7007 Walnut finish
	-9031 Left & Right Top	48	48	150	5.2	\$	541.00	
	-9032 Center Top & Rails (2 needed)	48	48	190	10.4	\$	874.00	
	-9033 Base (4 needed)			120	4.4	\$	476.00	
-9034 48" Rail Set (2 needed)			50	2.0	\$	228.00		
 Fairplex 18' Racetrack Expandable Conference Table 700_-216EX Consists of:				546	23.7	\$	2332.00	
	-9030 Left & Right Top	60	48	180	6.5	\$	688.00	
	-9032 Center Top & Rails (2 needed)	48	48	190	10.4	\$	874.00	
	-9033 Base (4 needed)			120	4.4	\$	476.00	
-9037 60" Rail Set (2 needed)			56	2.4	\$	294.00		
Fairplex 20' Racetrack Expandable Conference Table 700_-240EX Consists of:				635	28.3	\$	2675.00	<ul style="list-style-type: none"> • 7003 Grey finish • 7004 Mocha finish • 7005 Cognac Cherry finish • 7006 Mahogany finish • 7007 Walnut finish
	-9031 Left & Right Top	48	48	150	5.2	\$	541.00	
	-9032 Center Top & Rails (3 needed)	48	48	285	15.6	\$	1311.00	
	-9033 Base (5 needed)			150	5.5	\$	595.00	
-9034 48" Rail Set (2 needed)			50	2.0	\$	228.00		
Fairplex 22' Racetrack Expandable Conference Table 700_-264EX Consists of:				671	30.0	\$	2888.00	
	-9030 Left & Right Top	60	48	180	6.5	\$	688.00	
	-9032 Center Top & Rails (3 needed)	48	48	285	15.6	\$	1311.00	
	-9033 Base (5 needed)			150	5.5	\$	595.00	
-9037 60" Rail Set (2 needed)			56	2.4	\$	294.00		
Fairplex 60" Left & Right Section Race Track Expandable Conference Table Top 700_-9030	120	48		180	6.5	\$	688.00	<ul style="list-style-type: none"> • 7003 Grey finish • 7004 Mocha finish • 7005 Cognac Cherry finish • 7006 Mahogany finish • 7007 Walnut finish
	• 700_-9030 includes two 60" section tops							
Fairplex 48" Left & Right Section Race Track Expandable Conference Table Top 700_-9031	96	48		150	5.2	\$	541.00	<ul style="list-style-type: none"> • 700_-9031 includes two 48" section tops



DMI COLLECTION

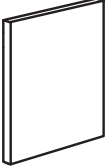
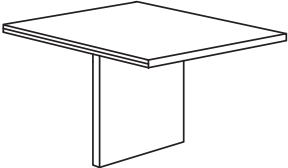
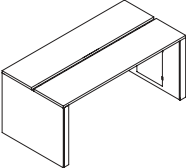
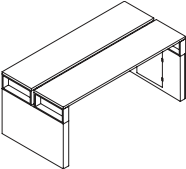
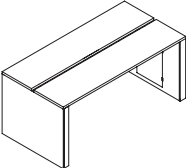
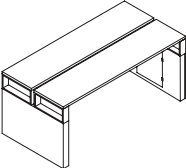
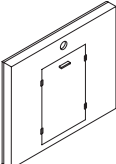

Item Description	Weight	Cubic	List	Features
Model Number	Lbs.	Ft.	Price	
 Fairplex 48" Center Section Expandable Conference Table Top and Rails	95	5.2	\$ 437.00	<ul style="list-style-type: none"> • 7003 Grey finish • 7004 Mocha finish • 7005 Cognac Cherry finish • 7006 Mahogany finish • 7007 Walnut finish • Includes 44" rails
700_-9032	48	48		
 Fairplex Expandable Conference Table Base	30	1.1	\$ 119.00	<ul style="list-style-type: none"> • 7003 Grey finish • 7004 Mocha finish • 7005 Cognac Cherry finish • 7006 Mahogany finish • 7007 Walnut finish
700_-9033				
 Fairplex 48" Center Section Top and Base	125	6.3	\$ 556.00	<ul style="list-style-type: none"> • 7003 Grey finish • 7004 Mocha finish • 7005 Cognac Cherry finish • 7006 Mahogany finish • 7007 Walnut finish
700_-903233	48	48	30	
Consists of:				
-9032 Center Top & Rails	48	48	95	5.2 \$ 437.00
-9033 Base			30	1.1 \$ 119.00
Fairplex Expandable Conference Table Rail Sets				<ul style="list-style-type: none"> • 7003 Grey finish • 7004 Mocha finish • 7005 Cognac Cherry finish • 7006 Mahogany finish • 7007 Walnut finish • 700_-9034 rail set for 700_-9031 • 700_-9037 rail set for 700_-9030 • 700_-9038 rail set for 700_-120EX
700_-9034	25	1.0	\$ 114.00	
700_-9037	28	1.2	\$ 147.00	
700_-9038	30	2.3	\$ 165.00	
 Inigo 72" High Top Conference Table	302	27.2	\$ 1429.00	<ul style="list-style-type: none"> • 7011 Smoke finish • 7012 Bourbon finish • 701_-001 base has solid end panel with storage for wiring, small splitters and surge protectors • Top ships in two pieces • Accommodates optional 0000-44 Cove Power Center
701_-72	72	48	42	
Consists of:				
-001 Storage Base	48	4.25	40.5	80 9.2 \$ 392.00
-002 Base	48	4.25	40.5	80 9.2 \$ 337.00
-005 Table Top with Cable Trough	72	48	1.5	142 8.8 \$ 700.00
 Inigo 72" High Top Conference Table with Metal	352	27.2	\$ 2042.00	<ul style="list-style-type: none"> • 7011 Smoke finish • 7012 Bourbon finish • 701_-003 base has solid end panel with storage for wiring, small splitters and surge protectors • Top ships in two pieces • Accommodates optional 0000-44 Cove Power Center
701_-72MB	72	48	42	
Consists of:				
-003 Metal Box Storage Base	48	4.25	40.5	105 9.2 \$ 704.00
-004 Metal Base	48	4.25	40.5	105 9.2 \$ 638.00
-005 Table Top with Cable Trough	72	48	1.5	142 8.8 \$ 700.00
 Inigo 96" High Top Conference Table	349	30.6	\$ 1547.00	<ul style="list-style-type: none"> • 7011 Smoke finish • 7012 Bourbon finish • 701_-001 base has solid end panel with storage for wiring, small splitters and surge protectors • Top ships in two pieces • Accommodates optional 0000-44 Cove Power Center
701_-96	96	48	42	
Consists of:				
-001 Storage Base	48	4.25	40.5	80 9.2 \$ 392.00
-002 Base	48	4.25	40.5	80 9.2 \$ 337.00
-006 Table Top with Cable Trough	96	48	1.5	189 12.2 \$ 818.00
 Inigo 96" High Top Conference Table with Metal	399	30.6	\$ 2160.00	<ul style="list-style-type: none"> • 7011 Smoke finish • 7012 Bourbon finish • 701_-003 base has solid end panel with storage for wiring, small splitters and surge protectors • Top ships in two pieces • Accommodates optional 0000-44 Cove Power Center
701_-96MB	96	48	42	
Consists of:				
-003 Metal Box Storage Base	48	4.25	40.5	105 9.2 \$ 704.00
-004 Metal Base	48	4.25	40.5	105 9.2 \$ 638.00
-006 Table Top with Cable Trough	96	48	1.5	189 12.2 \$ 818.00
 Inigo High Top Storage Base	80	9.2	\$ 392.00	<ul style="list-style-type: none"> • 7011 Smoke finish • 7012 Bourbon finish • Base has a solid end panel with storage for wiring, small splitters and surge protectors
701_-001	48	4.25	40.5	

Conference Tables LAMINATE COLLECTION

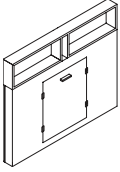
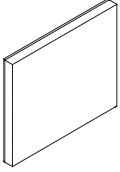
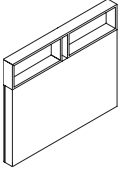
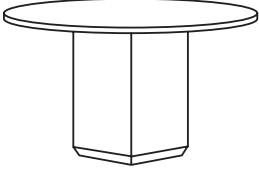
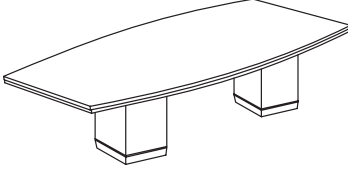
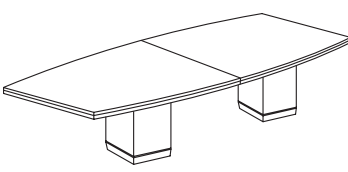
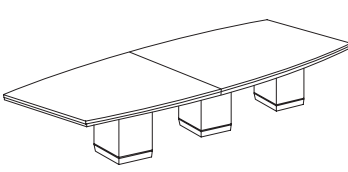
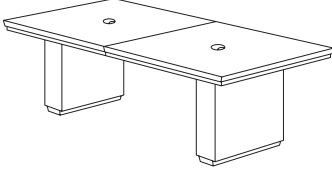

FLEXSTEEL®
CONTRACT

DMI COLLECTION

Item Description Model Number	W"	D"	H"	Weight Lbs.	Cubic Ft.	List Price	Features
 <p>Inigo High Top Storage Base with Metal Boxes 701_-003</p>	48	4.25	40.5	105	9.2	\$ 704.00	<ul style="list-style-type: none"> • 7011 Smoke finish • 7012 Bourbon finish • Base has a solid end panel with storage for wiring, small splitters and surge protectors
 <p>Inigo High Top Bases 701_-002</p>	48	4.25	40.5	80	9.2	\$ 337.00	<ul style="list-style-type: none"> • 7011 Smoke finish • 7012 Bourbon finish
 <p>Inigo High Top Bases with Metal Boxes 701_-004</p>	48	4.25	40.5	105	9.2	\$ 638.00	<ul style="list-style-type: none"> • 7011 Smoke finish • 7012 Bourbon finish
 <p>Pimlico 42" Round Conference Table 702_-89 Consists of: -011 Top -002 Square Pedestal Base</p>	42	42	30	108	11.8	\$ 540.00	<ul style="list-style-type: none"> • 7020 Mocha finish • 7027 Walnut finish
 <p>Pimlico 8' Boat Top Conference Table 702_-96 Consists of: -004 Top -002 Square Pedestal Base (2 needed)</p>	96	42	30	279	30.9	\$ 1578.00	<ul style="list-style-type: none"> • 7020 Mocha finish • 7027 Walnut finish
 <p>Pimlico 10' Boat Top Conference Table 702_-120 Consists of: -005 Two Piece Top -002 Square Pedestal Base (2 needed)</p>	120	48	30	284	37.3	\$ 1852.00	<ul style="list-style-type: none"> • 7020 Mocha finish • 7027 Walnut finish
 <p>Pimlico 12' Boat Top Conference Table 702_-144 Consists of: -006 Two Piece Top -002 Square Pedestal Base (3 needed)</p>	144	48	30	381	48.3	\$ 2196.00	<ul style="list-style-type: none"> • 7020 Mocha finish • 7027 Walnut finish
 <p>Pimlico 8' Rectangular Expandable Conference Table 702_-96REX Consists of: -9028 Left & Right Tops -9033 Bases (2 needed) -9034 Rail Set</p>	96	48	30	433	29.6	\$ 1983.00	<ul style="list-style-type: none"> • 7020 Mocha finish • 7027 Walnut finish • White tops available (7022) • Grommet in each top section • 702_-107 optional storage base available • Grommets accommodate optional 0000-38 Hide-A-Dock or 0000-42 Pop-up Station
 <p>Pimlico 10' Rectangular Expandable Conference Table 702_-120REX Consists of: -9029 Left & Right Tops -9033 Bases (2 needed) -9038 Rail Set</p>	120	48	30	455	32.8	\$ 2313.00	

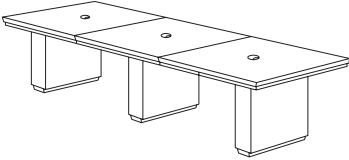
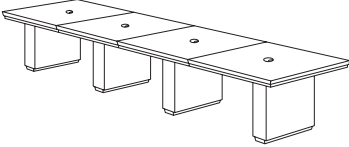
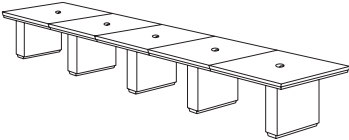
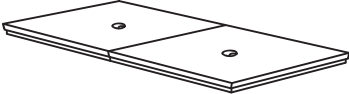
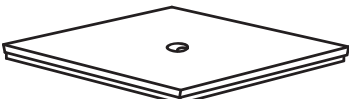

DMI COLLECTION

Item Description Model Number	W"	D"	H"	Weight Lbs.	Cubic Ft.	List Price	Features
	Pimlico 12' Rectangular Expandable Conference Table						
	702_-144REX	144	48	30	696	51.2	\$ 3781.00
	Consists of:						
	-9028 Left & Right Tops	48	48		233	12.5	\$ 1132.00
	-9032 Center Top & Rails	48	48		145	12.5	\$ 1288.00
	-9033 Bases (3 needed)	28	5.25	29	282	24.0	\$ 1083.00
-9035 Rail Set (2 needed)	42.5			36	2.2	\$ 278.00	
Pimlico 14' Rectangular Expandable Conference Table							
702_-168REX	168	48	30	712	54.2	\$ 4102.00	
Consists of:							
-9029 Left & Right Tops	60	48		245	15.1	\$ 1391.00	
-9032 Center Top & Rails	48	48		145	12.5	\$ 1288.00	
-9033 Bases (3 needed)	28	5.25	29	282	24.0	\$ 1083.00	
-9037 Rail Set (2 needed)	55			40	2.6	\$ 340.00	
	Pimlico 16' Rectangular Expandable Conference Table						
	702_-192REX	192	48	30	935	71.7	\$ 5430.00
	Consists of:						
	-9028 Left & Right Tops	48	48		233	12.5	\$ 1132.00
	-9032 Center Top & Rails (2 needed)	48	48		290	25.0	\$ 2576.00
	-9033 Bases (4 needed)	28	5.25	29	376	32.0	\$ 1444.00
-9035 Rail Set (2 needed)	42.5			36	2.2	\$ 278.00	
Pimlico 18' Rectangular Expandable Conference Table							
702_-216REX	216	48	30	951	74.7	\$ 5751.00	
Consists of:							
-9029 Left & Right Tops	60	48		245	15.1	\$ 1391.00	
-9032 Center Top & Rails (2 needed)	48	48		290	25.0	\$ 2576.00	
-9033 Bases (4 needed)	28	5.25	29	376	32.0	\$ 1444.00	
-9037 Rail Set (2 needed)	55			40	2.6	\$ 340.00	
	Pimlico 20' Rectangular Expandable Conference Table						
	702_-240REX	240	48	30	1174	92.2	\$ 7079.00
	Consists of:						
	-9028 Left & Right Tops	48	48		233	12.5	\$ 1132.00
	-9032 Center Top & Rails (3 needed)	48	48		435	37.5	\$ 3864.00
	-9033 Bases (5 needed)	28	5.25	29	470	40.0	\$ 1805.00
-9035 Rail Set (2 needed)	42.5			36	2.2	\$ 278.00	
Pimlico 22' Rectangular Expandable Conference Table							
702_-264REX	264	48	30	1190	95.2	\$ 7400.00	
Consists of:							
-9029 Left & Right Tops	60	48		245	15.1	\$ 1391.00	
-9032 Center Top & Rails (3 needed)	48	48		435	37.5	\$ 3864.00	
-9033 Bases (5 needed)	28	5.25	29	470	40.0	\$ 1805.00	
-9037 Rail Set (2 needed)	55			40	2.6	\$ 340.00	
	Pimlico 48" Left and Right Section Rectangular Expandable Table Top						
	702_-9028	96	48		233	12.5	\$ 1132.00
	Consists of:						
	-9028 Left & Right Tops	48	48		233	12.5	\$ 1132.00
Pimlico White 48" Left & Right Section Rectangular Expandable Table Top							
7022-9028	96	48		233	12.5	\$ 1132.00	
Consists of:							
-9028 Left & Right Tops	48	48		233	12.5	\$ 1132.00	
Pimlico 60" Left and Right Section Rectangular Expandable Table Top							
702_-9029	120	48		245	15.1	\$ 1391.00	
Consists of:							
-9029 Left & Right Tops	60	48		245	15.1	\$ 1391.00	
Pimlico White 60" Left & Right Section Rectangular Expandable Table Top							
7022-9029	120	48		245	15.1	\$ 1391.00	
Consists of:							
-9029 Left & Right Tops	60	48		245	15.1	\$ 1391.00	
	Pimlico 48" Center Section Expandable Table Top with 44" Rails						
	702_-9032	48	48		145	12.5	\$ 1288.00
Consists of:							
-9032 Center Top & Rails	48	48		145	12.5	\$ 1288.00	
Pimlico White 48" Center Section Expandable Table Top with 44" Rails							
7022-9032	48	48		145	12.5	\$ 1288.00	
Consists of:							
-9032 Center Top & Rails	48	48		145	12.5	\$ 1288.00	

Conference Tables LAMINATE COLLECTION



FLEXSTEEL®
CONTRACT



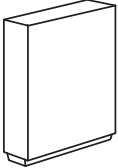
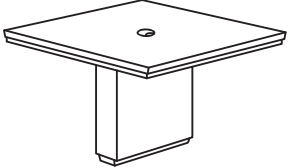

DMI COLLECTION

Item Description		W"	D"	H"	Weight	Cubic	List	Features
Model Number					Lbs.	Ft.	Price	
	Pimlico Expandable Conference Table Base							
	702_-9033	28	5.25	29	94	8.0	\$ 361.00	<ul style="list-style-type: none"> • 7020 Mocha finish • 7027 Walnut finish • 702_-017 must be placed at the end of the table
	Pimlico Expandable Conference Table Storage Base							
	702_-017	28	5.25	29	94	8.0	\$ 386.00	
	Pimlico 48" Center Section Top and Base							
	702_-903233	48	48	30	239	20.5	\$ 1649.00	<ul style="list-style-type: none"> • 7020 Mocha finish • 7027 Walnut finish • Grommet in top • Grommet accommodates optional 0000-38 Hide-A-Dock or 0000-42 Pop-up Station
	Consists of:							
	-9032 Center Top & Rails	48	48		145	12.5	\$ 1288.00	
	-9033 Base	28	5.25	29	94	8.0	\$ 361.00	
	Pimlico Expandable Conference Table Rail Sets							
	702_-9034	45			12	1.1	\$ 129.00	<ul style="list-style-type: none"> • 7020 Mocha finish • 7027 Walnut finish
	702_-9035	42.5			18	1.1	\$ 139.00	<ul style="list-style-type: none"> • 702_-9034 rail set for 702_96REX
	702_-9037	55			20	1.3	\$ 170.00	<ul style="list-style-type: none"> • 702_-9035 rail set for 702_-9028
	702_-9038	69.5			22	1.7	\$ 200.00	<ul style="list-style-type: none"> • 702_-9037 rail set for 702_-9029 • 702_-9038 rail set for 702_-120REX

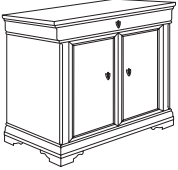
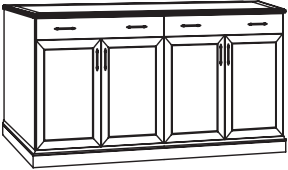

Buffets

DMI COLLECTION

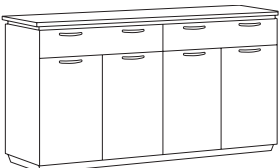
	Item Description	W"	D"	H"	Weight	Cubic	List	Features
	Model Number				Lbs.	Ft.	Price	
	Keswick Buffet 7990-25B	66	24	36	200	46.3	\$ 3192.00	<ul style="list-style-type: none"> • English Cherry finish • Two, felt-lined fully extending drawers with one having a silverware holder • Two cabinets each with an adjustable shelf • Heavy duty locking casters • Optional 0000-40 power center available
	Keswick Buffet 7990-26B	38	24	36	175	27.6	\$ 2598.00	<ul style="list-style-type: none"> • English Cherry finish • Two, felt-lined fully extending drawers • Two-door cabinet with an adjustable shelf • Heavy duty locking casters • Optional 0000-40 power center available
	Rue De Lyon Buffet 7684-26	38	24	36	203	26.0	\$ 1658.00	<ul style="list-style-type: none"> • Ruby Cabernet finish • One drawer with tableware tray • Two-door cabinet with two adjustable shelves • Four heavy duty casters • Optional 0000-40 power center available
	Belmont Buffet 713_-25B	66	24	36	200	41.0	\$ 3362.00	<ul style="list-style-type: none"> • 7130 Executive Cherry finish • 7132 Brown Cherry finish • Two felt-lined, fully extending drawers with one drawer having a silverware holder • Two cabinets each with an adjustable shelf • Four, heavy duty casters • Optional 0000-40 power center available
	Belmont Two Door Buffet 713_-26B	38	24	36	175	27.0	\$ 2790.00	<ul style="list-style-type: none"> • 7130 Executive Cherry finish • 7132 Brown Cherry finish • Felt-lined, fully extending drawer • One cabinet with an adjustable shelf • Four, heavy duty casters • Optional 0000-40 power center available
	Fairplex Buffet 700_-25	64.5	22.5	36	200	4.1	\$ 1961.00	<ul style="list-style-type: none"> • 7003 Grey finish • 7004 Mocha finish • 7005 Cognac Cherry finish • 7006 Mahogany finish • 7007 Walnut finish • Two, felt-lined, fully extending drawers with one having a silverware holder • Two cabinets, each with an adjustable shelf • Four heavy duty locking casters • Optional 0000-40 power center available
	Pimlico Buffet 702_-25	66	24	36	325	47.3	\$ 2055.00	<ul style="list-style-type: none"> • 7020 Mocha finish • 7027 Walnut finish • Two felt-lined fully extending drawers with one having a silverware holder • Two cabinets each with an adjustable shelf • Heavy duty locking casters • Optional 0000-40 power center available

***Optional 0000-40 Power Center works with the buffets in conjunction with TVs and other electronic devices**

Presentation Boards



FLEXSTEEL®
CONTRACT

DMI COLLECTION

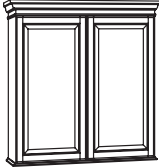
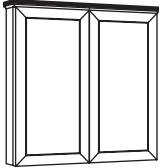
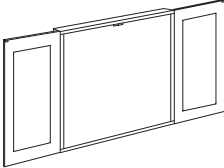
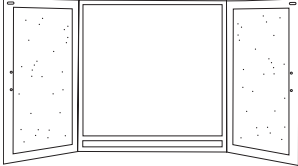
Item Description Model Number	W"	D"	H"	Weight Lbs.	Cubic Ft.	List Price	Features
 <p>Laminate Presentation Board 0000-650</p>	48	2	49	125	9.4	\$ 1223.00	<ul style="list-style-type: none"> • Mahogany finish • Open: 96" x 2" x 49" • Thermally fused melamine Mahogany finish coordinates with 7350 group • Features authentic poly-vinyl marker board to inhibit marker shadows and a tack board on the interior of each door
 <p>Keswick Presentation Board 7990-650</p>	48	4.75	49	106	9.2	\$ 1483.00	<ul style="list-style-type: none"> • English Cherry finish • Open: 96" x 4.75" x 49" • Features marker board and tack boards on interior of each door
 <p>Belmont Presentation Board 713_-650</p>	48	3.75	49	106	9.4	\$ 1629.00	<ul style="list-style-type: none"> • 7130 Executive Cherry finish • 7132 Brown Cherry finish • Open: 96" x 3.75" x 49" • Features marker board and tack boards on the interior of each door
 <p>Fairplex Presentation Board 700_-650</p>	47	5	47	126	27.8	\$ 1164.00	<ul style="list-style-type: none"> • 7003 Grey finish • 7004 Mocha finish • 7005 Cognac Cherry finish • 7006 Mahogany finish • 7007 Walnut finish • Open: 94" x 4.25" x 47" • Features a white magnetic marker board and a black fabric tack board on the interior of each door
 <p>Pimlico Presentation Board 702_-650</p>	48	4.25	48	123	12.1	\$ 1071.00	<ul style="list-style-type: none"> • 7020 Mocha Finish • 7027 Walnut Finish • Open: 96" x 2.75" x 48" • White, magnetic steel marker board • Cork tack board on the interior of each door; magnetic door latches; door stays stop doors at 180 degrees • Hangs on wall with "Z" rails and screws.



Occasional Tables

For specifications, see individual collections.



FLEXSTEEL®
CONTRACT



DMI COLLECTION

Occasional Tables



FLEXSTEEL®
CONTRACT

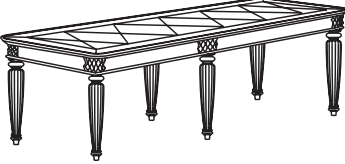
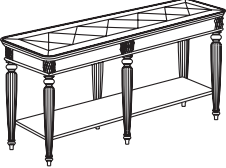

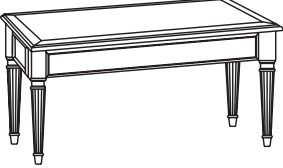
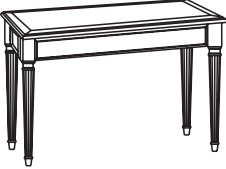
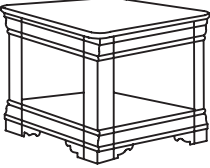
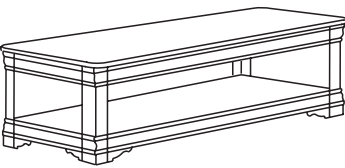
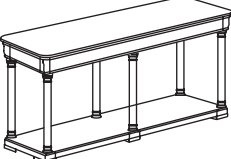
DMI COLLECTION

Item Description Model Number	W"	D"	H"	Weight Lbs.	Cubic Ft.	List Price	Features
 Antigua End Table 7480-10	24	24	20	31	3.4	\$ 613.00	<ul style="list-style-type: none"> • West Indies Cherry finish • Construction of veneer on MDF with wood legs • Minor assembly required
 Antigua Coffee Table 7480-40	50	24	17	51	6.2	\$ 698.00	<ul style="list-style-type: none"> • West Indies Cherry finish • Construction of veneer on MDF with wood legs • Minor assembly required
 Antigua Sofa/Console Table 7480-82	60	16.75	30	80	29.4	\$ 836.00	<ul style="list-style-type: none"> • West Indies Cherry finish • Construction of veneer on MDF with wood legs • Minor assembly required
 Keswick End Table 7990-10	24	24	24	50	3.1	\$ 605.00	<ul style="list-style-type: none"> • English Cherry finish • Constructed of veneer on MDF with wood legs
 Keswick Coffee Table 7990-40	48	24	18	50	6.3	\$ 756.00	<ul style="list-style-type: none"> • English Cherry finish • Constructed of veneer on MDF with wood legs
 Keswick Sofa/Console Table 7990-82	48	18	28	70	4.7	\$ 756.00	<ul style="list-style-type: none"> • English Cherry finish • Constructed of veneer on MDF with wood legs
 Rue De Lyon End Table 7684-10	24	24	20	45	4.9	\$ 458.00	<ul style="list-style-type: none"> • Ruby Cabernet finish • Construction of veneer on MDF with wood legs
 Rue De Lyon Coffee Table 7684-40	50	24	17	76	10.4	\$ 714.00	<ul style="list-style-type: none"> • Ruby Cabernet finish • Construction of veneer on MDF with wood legs
 Rue De Lyon Sofa/Console Table 7684-82	60	17	32	80	9.1	\$ 861.00	<ul style="list-style-type: none"> • Ruby Cabernet finish • Construction of veneer on MDF with wood legs

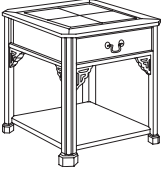
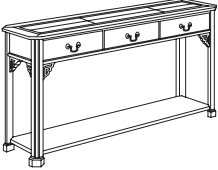
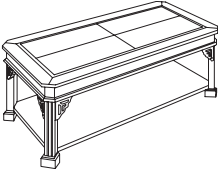
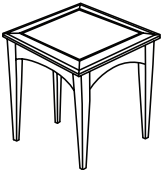
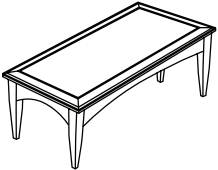
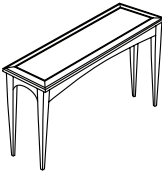
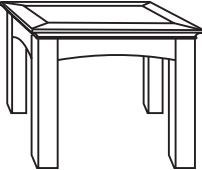

Occasional Tables

DMI COLLECTION

	Item Description	W"	D"	H"	Weight Lbs.	Cubic Ft.	List Price	Features
	Governors Rectangular End Table 7350-81	26	21	22	31	4.1	\$ 559.00	<ul style="list-style-type: none"> Engraved Executive Mahogany finish One drawer Construction of veneer on MDF with wood legs
	Governors Rectangular Sofa Table 7350-82	53	16	27	66	5.2	\$ 673.00	<ul style="list-style-type: none"> Engraved Executive Mahogany finish Three drawers Construction of veneer on MDF with wood legs
	Governors Rectangular Cocktail Table 7350-84	48	24	16	44	5.5	\$ 673.00	<ul style="list-style-type: none"> Engraved Executive Mahogany finish Construction of veneer on MDF with wood legs
	Belmont End Table 713_-10	24	24	24	30	4.9	\$ 707.00	<ul style="list-style-type: none"> 7130 Executive Cherry finish 7132 Brown Cherry finish Construction of veneer on MDF with wood legs
	Belmont Coffee Table 713_-40	48	24	18	40	6.4	\$ 920.00	<ul style="list-style-type: none"> 7130 Executive Cherry finish 7132 Brown Cherry finish Construction of veneer on MDF with wood legs
	Belmont Sofa/Console Table 713_-84	48	16	28	53	5.0	\$ 886.00	<ul style="list-style-type: none"> 7130 Executive Cherry finish 7132 Brown Cherry finish Construction of veneer on MDF with wood legs
	Del Mar End Table 7302-10	24	24	20	49	3.2	\$ 652.00	<ul style="list-style-type: none"> Sedona Cherry finish Construction of veneer on MDF with wood legs
	Del Mar Coffee Table 7302-40	50	24	16	75	3.6	\$ 905.00	<ul style="list-style-type: none"> Sedona Cherry finish Construction of veneer on MDF with wood legs
	Del Mar Sofa/Console Table 7302-82	60	16	30	78	5.7	\$ 882.00	<ul style="list-style-type: none"> Sedona Cherry finish Construction of veneer on MDF with wood legs

Occasional Tables



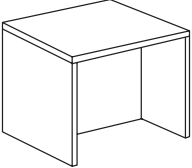

FLEXSTEEL®
CONTRACT

DMI COLLECTION

Item Description Model Number	W"	D"	H"	Weight Lbs.	Cubic Ft.	List Price	Features
 Fairplex End Table 700_-131	24	24	20	50	2.1	\$ 173.00	<ul style="list-style-type: none"> • 7003 Grey finish • 7004 Mocha finish • 7005 Cognac Cherry finish • 7006 Mahogany finish • 7007 Walnut finish • Requires assembly

Made-to-Order Occasional Tables

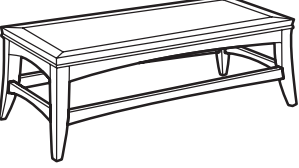
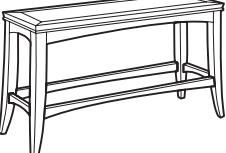
	Pratt Rectangular End Table C1076-01V	20	27	21.5		\$ 1496.00	<ul style="list-style-type: none"> • Available in Flexsteel Standard finishes
	Pratt Square End Table C1076-02V	27	27	21.5		\$ 1521.00	<ul style="list-style-type: none"> • Available in Flexsteel Standard finishes
	Pratt Rectangular Coffee Table C1076-03V	48	22	15.5		\$ 2190.00	<ul style="list-style-type: none"> • Available in Flexsteel Standard finishes
	Pratt Rectangular Sofa Table C1076-04V	48	16	26		\$ 1801.00	<ul style="list-style-type: none"> • Available in Flexsteel Standard finishes



Seating Solutions

Made-to-Order and In-Stock

Our made-to-order and in-stock seating solutions are born from industry knowledge and crafted to offer a distinct look and feel to suit any office aesthetic.



FLEXSTEEL®
CONTRACT

DMI COLLECTION

Seating Solutions



FLEXSTEEL®
CONTRACT

Made-to-Order Collections

Item Description

Model Number	W"	D"	H"	Fabric Grade	List Price
Alvar Chair OC726-10	30	37	39	SG 04.....	\$ 1485.00
				SG 05.....	\$ 1516.00
				SG 06.....	\$ 1546.00
				SG 08.....	\$ 1607.00
				SG 10.....	\$ 1667.00
				SG 12.....	\$ 1728.00
				SG 14.....	\$ 1789.00
				SG 16.....	\$ 1850.00
				SG 18.....	\$ 1910.00
				SG 20.....	\$ 1971.00
				SG 22.....	\$ 2032.00
				SG 24.....	\$ 2092.00
				SG 26.....	\$ 2153.00
				SG 28.....	\$ 2214.00
				SG 30.....	\$ 2275.00
				COM.....	\$ 1485.00

- Seat height: 20"
- Seat width: 20"
- Seat depth: 22"
- Arm height: 25"
- COM yardage: 6.1
- Nailhead trim standard

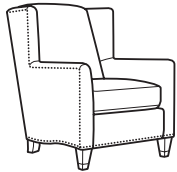

Alvar Sofa OC726-31	77	41	38	SG 04.....	\$ 2908.00
				SG 05.....	\$ 2975.00
				SG 06.....	\$ 3041.00
				SG 08.....	\$ 3173.00
				SG 10.....	\$ 3306.00
				SG 12.....	\$ 3438.00
				SG 14.....	\$ 3571.00
				SG 16.....	\$ 3703.00
				SG 18.....	\$ 3835.00
				SG 20.....	\$ 3968.00
				SG 22.....	\$ 4100.00
				SG 24.....	\$ 4233.00
				SG 26.....	\$ 4365.00
				SG 28.....	\$ 4497.00
				SG 30.....	\$ 4630.00
				COM.....	\$ 2908.00

- Seat height: 20"
- Seat width: 67"
- Seat depth: 22"
- Arm height: 25"
- COM yardage: 13.3
- Nailhead trim standard

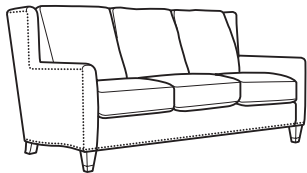

Colt Loveseat OC007-20	53.5	34.5	36	SG 04.....	\$ 1498.00
				SG 05.....	\$ 1534.00
				SG 06.....	\$ 1569.00
				SG 08.....	\$ 1641.00
				SG 10.....	\$ 1713.00
				SG 12.....	\$ 1785.00
				SG 14.....	\$ 1856.00
				SG 16.....	\$ 1928.00
				SG 18.....	\$ 2000.00
				SG 20.....	\$ 2071.00
				SG 22.....	\$ 2143.00
				SG 24.....	\$ 2215.00
				SG 26.....	\$ 2286.00
				SG 28.....	\$ 2358.00
				SG 30.....	\$ 2430.00
				COM.....	\$ 1498.00

- Seat height: 20"
- Seat width: 42"
- Seat depth: 21"
- Arm height: 26.5"
- COM yardage: 7.2

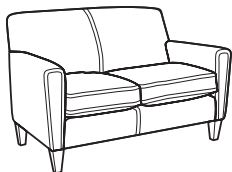

Crosby Lounge Chair OC015-10	30.5	30.5	29.5	SG 04.....	\$ 1191.00
				SG 05.....	\$ 1212.00
				SG 06.....	\$ 1233.00
				SG 08.....	\$ 1275.00
				SG 10.....	\$ 1316.00
				SG 12.....	\$ 1358.00
				SG 14.....	\$ 1400.00
				SG 16.....	\$ 1442.00
				SG 18.....	\$ 1484.00
				SG 20.....	\$ 1526.00
				SG 22.....	\$ 1567.00
				SG 24.....	\$ 1609.00
				SG 26.....	\$ 1651.00
				SG 28.....	\$ 1693.00
				SG 30.....	\$ 1735.00
				COM.....	\$ 1191.00

- Seat height: 19"
- Seat width: 21"
- Seat depth: 21"
- Arm height: 29"
- COM yardage: 4.2

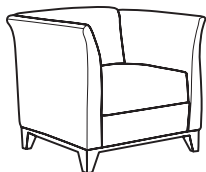

Item Description

Model Number	W"	D"	H"	Fabric Grade	List Price
Alvar Loveseat OC726-20	52	41	38	SG 04.....	\$ 2371.00
				SG 05.....	\$ 2421.00
				SG 06.....	\$ 2471.00
				SG 08.....	\$ 2571.00
				SG 10.....	\$ 2670.00
				SG 12.....	\$ 2770.00
				SG 14.....	\$ 2869.00
				SG 16.....	\$ 2969.00
				SG 18.....	\$ 3068.00
				SG 20.....	\$ 3168.00
				SG 22.....	\$ 3267.00
				SG 24.....	\$ 3367.00
				SG 26.....	\$ 3467.00
				SG 28.....	\$ 3566.00
				SG 30.....	\$ 3666.00
				COM.....	\$ 2371.00

- Seat height: 20"
- Seat width: 42"
- Seat depth: 22"
- Arm height: 25"
- COM yardage: 10.0
- Nailhead trim standard

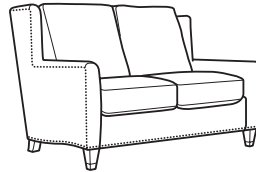

Colt Chair OC007-10	31.5	31	35.5	SG 04.....	\$ 1035.00
				SG 05.....	\$ 1058.00
				SG 06.....	\$ 1081.00
				SG 08.....	\$ 1126.00
				SG 10.....	\$ 1172.00
				SG 12.....	\$ 1218.00
				SG 14.....	\$ 1264.00
				SG 16.....	\$ 1310.00
				SG 18.....	\$ 1355.00
				SG 20.....	\$ 1401.00
				SG 22.....	\$ 1447.00
				SG 24.....	\$ 1493.00
				SG 26.....	\$ 1539.00
				SG 28.....	\$ 1584.00
				SG 30.....	\$ 1630.00
				COM.....	\$ 1035.00

- Seat height: 20.5"
- Seat width: 20"
- Seat depth: 18.25"
- Arm height: 26.5"
- COM yardage: 4.6

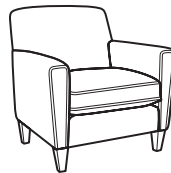

Colt Sofa OC007-31	80	36	36	SG 04.....	\$ 2004.00
				SG 05.....	\$ 2051.00
				SG 06.....	\$ 2098.00
				SG 08.....	\$ 2193.00
				SG 10.....	\$ 2287.00
				SG 12.....	\$ 2382.00
				SG 14.....	\$ 2477.00
				SG 16.....	\$ 2571.00
				SG 18.....	\$ 2666.00
				SG 20.....	\$ 2760.00
				SG 22.....	\$ 2855.00
				SG 24.....	\$ 2949.00
				SG 26.....	\$ 3044.00
				SG 28.....	\$ 3139.00
				SG 30.....	\$ 3233.00
				COM.....	\$ 2004.00

- Seat height: 20"
- Seat width: 68"
- Seat depth: 22"
- Arm height: 26.5"
- COM yardage: 9.5

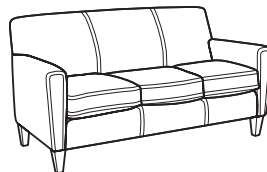

Crosby Loveseat OC015-20	58	30.5	29.5	SG 04.....	\$ 1521.00
				SG 05.....	\$ 1550.00
				SG 06.....	\$ 1579.00
				SG 08.....	\$ 1638.00
				SG 10.....	\$ 1697.00
				SG 12.....	\$ 1756.00
				SG 14.....	\$ 1814.00
				SG 16.....	\$ 1873.00
				SG 18.....	\$ 1932.00
				SG 20.....	\$ 1991.00
				SG 22.....	\$ 2049.00
				SG 24.....	\$ 2108.00
				SG 26.....	\$ 2167.00
				SG 28.....	\$ 2225.00
				SG 30.....	\$ 2284.00
				COM.....	\$ 1521.00

- Seat height: 18"
- Seat width: 48"
- Seat depth: 20"
- Arm height: 29"
- COM yardage: 5.9

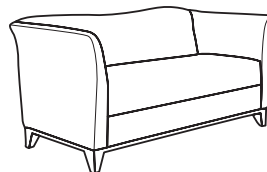



Made-to-Order Collections

Item Description	W"	D"	H"	Fabric Grade	List Price
Dondi Chair OC032-10	27	29.25	34.75	SG 04.....	\$ 1274.00
				SG 05.....	\$ 1296.00
				SG 06.....	\$ 1318.00
				SG 08.....	\$ 1362.00
				SG 10.....	\$ 1405.00
				SG 12.....	\$ 1449.00
				SG 14.....	\$ 1493.00
				SG 16.....	\$ 1537.00
				SG 18.....	\$ 1581.00
				SG 20.....	\$ 1624.00
				SG 22.....	\$ 1668.00
				SG 24.....	\$ 1712.00
				SG 26.....	\$ 1756.00
				SG 28.....	\$ 1800.00
				SG 30.....	\$ 1843.00
				COM.....	\$ 1274.00



Dondi Loveseat OC032-20	49	29.25	34.75	SG 04.....	\$ 1567.00
				SG 05.....	\$ 1595.00
				SG 06.....	\$ 1623.00
				SG 08.....	\$ 1679.00
				SG 10.....	\$ 1735.00
				SG 12.....	\$ 1790.00
				SG 14.....	\$ 1846.00
				SG 16.....	\$ 1902.00
				SG 18.....	\$ 1958.00
				SG 20.....	\$ 2013.00
				SG 22.....	\$ 2069.00
				SG 24.....	\$ 2125.00
				SG 26.....	\$ 2181.00
				SG 28.....	\$ 2236.00
				SG 30.....	\$ 2292.00
				COM.....	\$ 1567.00

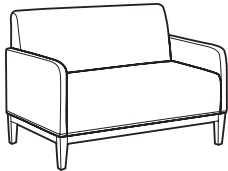

Dondi Bench OC032-21	44	20	25	SG 04.....	\$ 1162.00
				SG 05.....	\$ 1178.00
				SG 06.....	\$ 1193.00
				SG 08.....	\$ 1225.00
				SG 10.....	\$ 1257.00
				SG 12.....	\$ 1289.00
				SG 14.....	\$ 1321.00
				SG 16.....	\$ 1353.00
				SG 18.....	\$ 1385.00
				SG 20.....	\$ 1416.00
				SG 22.....	\$ 1448.00
				SG 24.....	\$ 1480.00
				SG 26.....	\$ 1512.00
				SG 28.....	\$ 1544.00
				SG 30.....	\$ 1576.00
				COM.....	\$ 1162.00

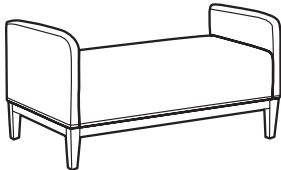

Dondi Sofa OC032-30	71	29.25	34.75	SG 04.....	\$ 1846.00
				SG 05.....	\$ 1884.00
				SG 06.....	\$ 1922.00
				SG 08.....	\$ 1998.00
				SG 10.....	\$ 2073.00
				SG 12.....	\$ 2149.00
				SG 14.....	\$ 2225.00
				SG 16.....	\$ 2300.00
				SG 18.....	\$ 2376.00
				SG 20.....	\$ 2452.00
				SG 22.....	\$ 2527.00
				SG 24.....	\$ 2603.00
				SG 26.....	\$ 2679.00
				SG 28.....	\$ 2754.00
				SG 30.....	\$ 2830.00
				COM.....	\$ 1846.00

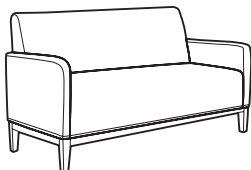

Item Description	W"	D"	H"	Fabric Grade	List Price
Dondi Chair OC032-10Q	27	29.25	34.75	SG 04.....	\$ 1266.00
				SG 05.....	\$ 1289.00
				SG 06.....	\$ 1312.00
				SG 08.....	\$ 1358.00
				SG 10.....	\$ 1403.00
				SG 12.....	\$ 1449.00
				SG 14.....	\$ 1495.00
				SG 16.....	\$ 1541.00
				SG 18.....	\$ 1587.00
				SG 20.....	\$ 1632.00
				SG 22.....	\$ 1678.00
				SG 24.....	\$ 1724.00
				SG 26.....	\$ 1770.00
				SG 28.....	\$ 1816.00
				SG 30.....	\$ 1861.00
				COM.....	\$ 1266.00

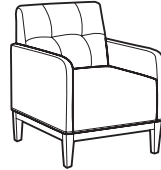

Dondi Loveseat OC032-20Q	49	29.25	34.75	SG 04.....	\$ 1582.00
				SG 05.....	\$ 1611.00
				SG 06.....	\$ 1640.00
				SG 08.....	\$ 1698.00
				SG 10.....	\$ 1756.00
				SG 12.....	\$ 1813.00
				SG 14.....	\$ 1871.00
				SG 16.....	\$ 1929.00
				SG 18.....	\$ 1987.00
				SG 20.....	\$ 2044.00
				SG 22.....	\$ 2102.00
				SG 24.....	\$ 2160.00
				SG 26.....	\$ 2218.00
				SG 28.....	\$ 2275.00
				SG 30.....	\$ 2333.00
				COM.....	\$ 1582.00

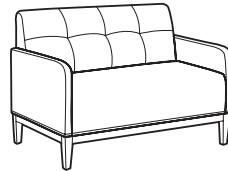

Dondi Bench OC032-21Q	44	20	25	SG 04.....	\$ 1123.00
				SG 05.....	\$ 1140.00
				SG 06.....	\$ 1157.00
				SG 08.....	\$ 1191.00
				SG 10.....	\$ 1225.00
				SG 12.....	\$ 1259.00
				SG 14.....	\$ 1293.00
				SG 16.....	\$ 1326.00
				SG 18.....	\$ 1360.00
				SG 20.....	\$ 1394.00
				SG 22.....	\$ 1428.00
				SG 24.....	\$ 1462.00
				SG 26.....	\$ 1496.00
				SG 28.....	\$ 1530.00
				SG 30.....	\$ 1563.00
				COM.....	\$ 1123.00

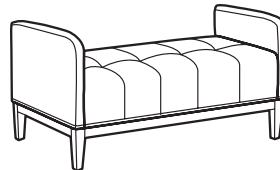

Dondi Sofa OC032-30Q	71	29.25	34.75	SG 04.....	\$ 1843.00
				SG 05.....	\$ 1881.00
				SG 06.....	\$ 1918.00
				SG 08.....	\$ 1993.00
				SG 10.....	\$ 2067.00
				SG 12.....	\$ 2142.00
				SG 14.....	\$ 2217.00
				SG 16.....	\$ 2291.00
				SG 18.....	\$ 2366.00
				SG 20.....	\$ 2441.00
				SG 22.....	\$ 2515.00
				SG 24.....	\$ 2590.00
				SG 26.....	\$ 2665.00
				SG 28.....	\$ 2739.00
				SG 30.....	\$ 2814.00
				COM.....	\$ 1843.00

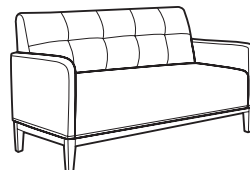

Seating Solutions



FLEXSTEEL®
CONTRACT

Made-to-Order Collections

Item Description

Model Number	W"	D"	H"	Fabric Grade	List Price
Edson Chair OC004-10	38	35	31	SG 04.....\$	1786.00
				SG 05.....\$	1817.00
				SG 06.....\$	1848.00
				SG 08.....\$	1910.00
				SG 10.....\$	1971.00
				SG 12.....\$	2033.00
				SG 14.....\$	2095.00
				SG 16.....\$	2157.00
				SG 18.....\$	2218.00
				SG 20.....\$	2280.00
				SG 22.....\$	2342.00
				SG 24.....\$	2403.00
				SG 26.....\$	2465.00
				SG 28.....\$	2527.00
				SG 30.....\$	2589.00
				COM.....\$	1786.00

- Seat height: 19"
- Seat width: 23"
- Seat depth: 21"
- Arm height: 27"
- COM yardage: 6.2
- Available in railroad, non-match fabrics only
- Base available in polished chrome only

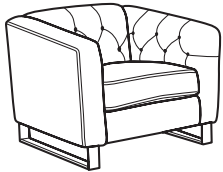

Edson Sofa OC004-31	81	35	31	SG 04.....\$	2742.00
				SG 05.....\$	2796.00
				SG 06.....\$	2849.00
				SG 08.....\$	2955.00
				SG 10.....\$	3062.00
				SG 12.....\$	3169.00
				SG 14.....\$	3275.00
				SG 16.....\$	3382.00
				SG 18.....\$	3488.00
				SG 20.....\$	3595.00
				SG 22.....\$	3701.00
				SG 24.....\$	3808.00
				SG 26.....\$	3914.00
				SG 28.....\$	4021.00
				SG 30.....\$	4127.00
				COM.....\$	2742.00

- Seat height: 19"
- Seat width: 66"
- Seat depth: 21"
- Arm height: 27"
- COM yardage: 10.7
- Available in railroad, non-match fabrics only
- Base available in polished chrome only

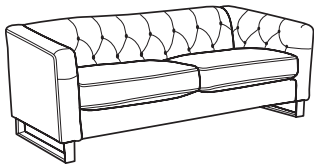

Fuller Sofa O5937-30Z	76.5	38	37	SG 04.....\$	2155.00
				SG 05.....\$	2202.00
				SG 06.....\$	2250.00
				SG 08.....\$	2344.00
				SG 10.....\$	2439.00
				SG 12.....\$	2533.00
				SG 14.....\$	2628.00
				SG 16.....\$	2723.00
				SG 18.....\$	2817.00
				SG 20.....\$	2912.00
				SG 22.....\$	3006.00
				SG 24.....\$	3101.00
				SG 26.....\$	3196.00
				SG 28.....\$	3290.00
				SG 30.....\$	3385.00
				COM.....\$	2155.00

- Seat height: 20.5"
- Seat width: 59"
- Seat depth: 21.5"
- Arm height: 27"
- COM yardage: 9.5

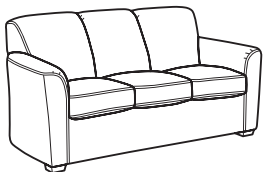

Graves Loveseat O2088-20Z	51.5	36	34.5	SG 04.....\$	1783.00
				SG 05.....\$	1820.00
				SG 06.....\$	1857.00
				SG 08.....\$	1931.00
				SG 10.....\$	2004.00
				SG 12.....\$	2078.00
				SG 14.....\$	2152.00
				SG 16.....\$	2225.00
				SG 18.....\$	2299.00
				SG 20.....\$	2373.00
				SG 22.....\$	2446.00
				SG 24.....\$	2520.00
				SG 26.....\$	2594.00
				SG 28.....\$	2667.00
				SG 30.....\$	2741.00
				COM.....\$	1783.00

- Seat height: 20"
- Seat width: 41.5"
- Seat depth: 21"
- Arm height: 26.5"
- COM yardage: 7.4

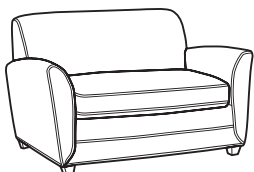

Item Description

Model Number	W"	D"	H"	Fabric Grade	List Price
Edson Loveseat OC004-20	56	35	31	SG 04.....\$	2316.00
				SG 05.....\$	2357.00
				SG 06.....\$	2399.00
				SG 08.....\$	2483.00
				SG 10.....\$	2567.00
				SG 12.....\$	2650.00
				SG 14.....\$	2734.00
				SG 16.....\$	2817.00
				SG 18.....\$	2901.00
				SG 20.....\$	2985.00
				SG 22.....\$	3068.00
				SG 24.....\$	3152.00
				SG 26.....\$	3236.00
				SG 28.....\$	3319.00
				SG 30.....\$	3403.00
				COM.....\$.00

- Seat height: 19"
- Seat width: 41"
- Seat depth: 21"
- Arm height: 27"
- COM yardage: 8.4
- Available in railroad, non-match fabrics only
- Base available in polished chrome only

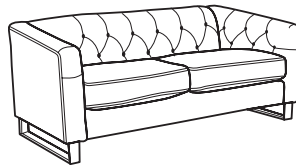

Fuller Loveseat O5937-20Z	56.5	38	37	SG 04.....\$	1653.00
				SG 05.....\$	1691.00
				SG 06.....\$	1730.00
				SG 08.....\$	1806.00
				SG 10.....\$	1883.00
				SG 12.....\$	1960.00
				SG 14.....\$	2036.00
				SG 16.....\$	2113.00
				SG 18.....\$	2190.00
				SG 20.....\$	2266.00
				SG 22.....\$	2343.00
				SG 24.....\$	2420.00
				SG 26.....\$	2496.00
				SG 28.....\$	2573.00
				SG 30.....\$	2650.00
				COM.....\$	1653.00
				COM.....\$.00

- Seat height: 20.5"
- Seat width: 39"
- Seat depth: 21.5"
- Arm height: 27"
- COM yardage: 7.7

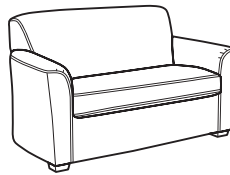

Graves Chair O2088-10	32	35.25	34	SG 04.....\$	1182.00
				SG 05.....\$	1203.00
				SG 06.....\$	1224.00
				SG 08.....\$	1266.00
				SG 10.....\$	1308.00
				SG 12.....\$	1350.00
				SG 14.....\$	1391.00
				SG 16.....\$	1433.00
				SG 18.....\$	1475.00
				SG 20.....\$	1517.00
				SG 22.....\$	1559.00
				SG 24.....\$	1600.00
				SG 26.....\$	1642.00
				SG 28.....\$	1684.00
				SG 30.....\$	1726.00
				COM.....\$	1182.00

- Seat height: 18.25"
- Seat width: 20"
- Seat depth: 22.25"
- Arm height: 26.5"
- COM yardage: 4.2

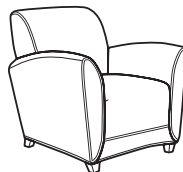

Graves Sofa O2088-30Z	71.5	36	34.5	SG 04.....\$	2020.00
				SG 05.....\$	2066.00
				SG 06.....\$	2112.00
				SG 08.....\$	2205.00
				SG 10.....\$	2298.00
				SG 12.....\$	2390.00
				SG 14.....\$	2483.00
				SG 16.....\$	2575.00
				SG 18.....\$	2668.00
				SG 20.....\$	2760.00
				SG 22.....\$	2853.00
				SG 24.....\$	2946.00
				SG 26.....\$	3038.00
				SG 28.....\$	3131.00
				SG 30.....\$	3223.00
				COM.....\$	2020.00

- Seat height: 20"
- Seat width: 61.5"
- Seat depth: 21"
- Arm height: 26.5"
- COM yardage: 9.3

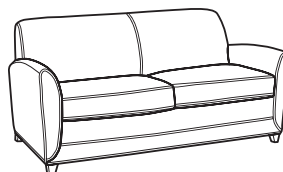



Made-to-Order Collections

Item Description	W"	D"	H"	Fabric Grade	List Price
Greco Chair O2029-10	35.75	38	37	SG 04.....	\$ 1252.00
				SG 05.....	\$ 1277.00
				SG 06.....	\$ 1302.00
				SG 08.....	\$ 1351.00
				SG 10.....	\$ 1401.00
				SG 12.....	\$ 1451.00
				SG 14.....	\$ 1501.00
				SG 16.....	\$ 1550.00
				SG 18.....	\$ 1600.00
				SG 20.....	\$ 1650.00
				SG 22.....	\$ 1700.00
				SG 24.....	\$ 1750.00
				SG 26.....	\$ 1799.00
				SG 28.....	\$ 1849.00
				SG 30.....	\$ 1899.00
				COM.....	\$ 1252.00

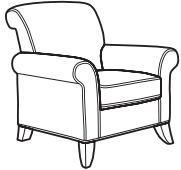

				SG 04.....	\$ 2107.00
				SG 05.....	\$ 2151.00
				SG 06.....	\$ 2194.00
				SG 08.....	\$ 2282.00
				SG 10.....	\$ 2370.00
				SG 12.....	\$ 2457.00
				SG 14.....	\$ 2545.00
				SG 16.....	\$ 2632.00
				SG 18.....	\$ 2720.00
				SG 20.....	\$ 2808.00
				SG 22.....	\$ 2895.00
				SG 24.....	\$ 2983.00
				SG 26.....	\$ 3071.00
				SG 28.....	\$ 3158.00
				SG 30.....	\$ 3246.00
				COM.....	\$ 2107.00

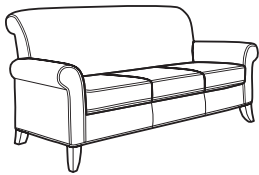

				SG 04.....	\$ 1643.00
				SG 05.....	\$ 1682.00
				SG 06.....	\$ 1720.00
				SG 08.....	\$ 1797.00
				SG 10.....	\$ 1873.00
				SG 12.....	\$ 1950.00
				SG 14.....	\$ 2027.00
				SG 16.....	\$ 2103.00
				SG 18.....	\$ 2180.00
				SG 20.....	\$ 2257.00
				SG 22.....	\$ 2333.00
				SG 24.....	\$ 2410.00
				SG 26.....	\$ 2487.00
				SG 28.....	\$ 2563.00
				SG 30.....	\$ 2640.00
				COM.....	\$ 1643.00

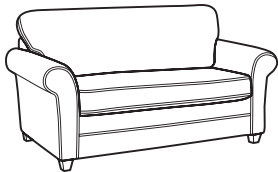

				SG 04.....	\$ 1345.00
				SG 05.....	\$ 1365.00
				SG 06.....	\$ 1385.00
				SG 08.....	\$ 1424.00
				SG 10.....	\$ 1464.00
				SG 12.....	\$ 1504.00
				SG 14.....	\$ 1544.00
				SG 16.....	\$ 1584.00
				SG 18.....	\$ 1623.00
				SG 20.....	\$ 1663.00
				SG 22.....	\$ 1703.00
				SG 24.....	\$ 1743.00
				SG 26.....	\$ 1783.00
				SG 28.....	\$ 1823.00
				SG 30.....	\$ 1862.00
				COM.....	\$ 1345.00



Item Description	W"	D"	H"	Fabric Grade	List Price
Greco Loveseat O2029-20	55.75	38	37	SG 04.....	\$ 1831.00
				SG 05.....	\$ 1866.00
				SG 06.....	\$ 1901.00
				SG 08.....	\$ 1970.00
				SG 10.....	\$ 2040.00
				SG 12.....	\$ 2110.00
				SG 14.....	\$ 2180.00
				SG 16.....	\$ 2249.00
				SG 18.....	\$ 2319.00
				SG 20.....	\$ 2389.00
				SG 22.....	\$ 2458.00
				SG 24.....	\$ 2528.00
				SG 26.....	\$ 2598.00
				SG 28.....	\$ 2667.00
				SG 30.....	\$ 2737.00
				COM.....	\$ 1831.00

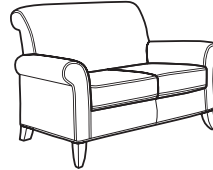

				SG 04.....	\$ 1197.00
				SG 05.....	\$ 1226.00
				SG 06.....	\$ 1255.00
				SG 08.....	\$ 1314.00
				SG 10.....	\$ 1373.00
				SG 12.....	\$ 1432.00
				SG 14.....	\$ 1490.00
				SG 16.....	\$ 1549.00
				SG 18.....	\$ 1608.00
				SG 20.....	\$ 1667.00
				SG 22.....	\$ 1725.00
				SG 24.....	\$ 1784.00
				SG 26.....	\$ 1843.00
				SG 28.....	\$ 1902.00
				SG 30.....	\$ 1960.00
				COM.....	\$ 1197.00

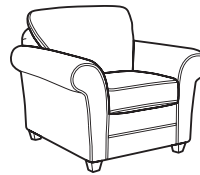

				SG 04.....	\$ 2043.00
				SG 05.....	\$ 2094.00
				SG 06.....	\$ 2146.00
				SG 08.....	\$ 2248.00
				SG 10.....	\$ 2351.00
				SG 12.....	\$ 2453.00
				SG 14.....	\$ 2556.00
				SG 16.....	\$ 2658.00
				SG 18.....	\$ 2761.00
				SG 20.....	\$ 2863.00
				SG 22.....	\$ 2966.00
				SG 24.....	\$ 3068.00
				SG 26.....	\$ 3171.00
				SG 28.....	\$ 3274.00
				SG 30.....	\$ 3376.00
				COM.....	\$ 2043.00

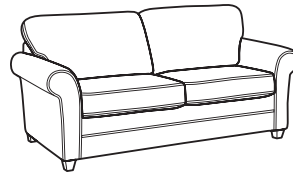

				SG 04.....	\$ 1614.00
				SG 05.....	\$ 1640.00
				SG 06.....	\$ 1665.00
				SG 08.....	\$ 1716.00
				SG 10.....	\$ 1767.00
				SG 12.....	\$ 1817.00
				SG 14.....	\$ 1868.00
				SG 16.....	\$ 1919.00
				SG 18.....	\$ 1970.00
				SG 20.....	\$ 2020.00
				SG 22.....	\$ 2071.00
				SG 24.....	\$ 2122.00
				SG 26.....	\$ 2173.00
				SG 28.....	\$ 2224.00
				SG 30.....	\$ 2274.00
				COM.....	\$ 1614.00

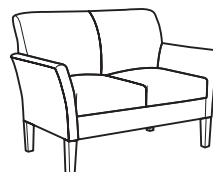

Seating Solutions



FLEXSTEEL®
CONTRACT

Made-to-Order Collections

Item Description

Model Number	W"	D"	H"	Fabric Grade	List Price
Latimer Bench OC017-21	50	20	25	SG 04.....\$	1143.00
				SG 05.....\$	1158.00
				SG 06.....\$	1174.00
				SG 08.....\$	1205.00
				SG 10.....\$	1236.00
				SG 12.....\$	1266.00
				SG 14.....\$	1297.00
				SG 16.....\$	1328.00
				SG 18.....\$	1359.00
				SG 20.....\$	1390.00
				SG 22.....\$	1421.00
				SG 24.....\$	1452.00
				SG 26.....\$	1483.00
				SG 28.....\$	1513.00
				SG 30.....\$	1544.00
				COM.....\$	1143.00

- Seat height: 18.75"
- Seat width: 40"
- Seat depth: 20"
- Arm height: 25"
- COM yardage: 3.1

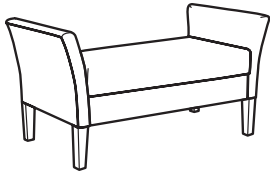

Maas Chair O2570-10	35.5	36	34	SG 04.....\$	1185.00
				SG 05.....\$	1209.00
				SG 06.....\$	1233.00
				SG 08.....\$	1282.00
				SG 10.....\$	1331.00
				SG 12.....\$	1380.00
				SG 14.....\$	1429.00
				SG 16.....\$	1477.00
				SG 18.....\$	1526.00
				SG 20.....\$	1575.00
				SG 22.....\$	1624.00
				SG 24.....\$	1673.00
				SG 26.....\$	1721.00
				SG 28.....\$	1770.00
				SG 30.....\$	1819.00
				COM.....\$	1185.00

- Seat height: 19.5"
- Seat width: 20"
- Seat depth: 19.5"
- Arm height: 27.25"
- COM yardage: 4.9

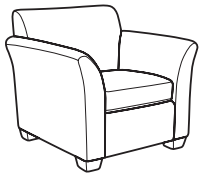

Maas Sofa O2570-30Z	74	34.5	34.5	SG 04.....\$	1896.00
				SG 05.....\$	1940.00
				SG 06.....\$	1983.00
				SG 08.....\$	2070.00
				SG 10.....\$	2156.00
				SG 12.....\$	2243.00
				SG 14.....\$	2330.00
				SG 16.....\$	2416.00
				SG 18.....\$	2503.00
				SG 20.....\$	2589.00
				SG 22.....\$	2676.00
				SG 24.....\$	2763.00
				SG 26.....\$	2849.00
				SG 28.....\$	2936.00
				SG 30.....\$	3022.00
				COM.....\$	1896.00

- Seat height: 19.5"
- Seat width: 58.25"
- Seat depth: 22"
- Arm height: 27.25"
- COM yardage: 8.7

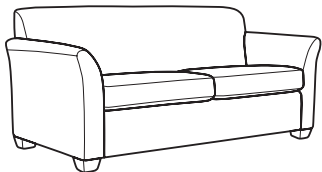

Meier Loveseat O2063-20Z	56.5	34.25	37.75	SG 04.....\$	1690.00
				SG 05.....\$	1725.00
				SG 06.....\$	1760.00
				SG 08.....\$	1830.00
				SG 10.....\$	1899.00
				SG 12.....\$	1969.00
				SG 14.....\$	2039.00
				SG 16.....\$	2108.00
				SG 18.....\$	2178.00
				SG 20.....\$	2248.00
				SG 22.....\$	2318.00
				SG 24.....\$	2387.00
				SG 26.....\$	2457.00
				SG 28.....\$	2527.00
				SG 30.....\$	2596.00
				COM.....\$	1690.00

- Seat height: 19.75"
- Seat width: 40"
- Seat depth: 22"
- Arm height: 25.5"
- COM yardage: 7.0

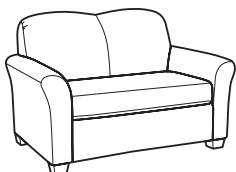

Item Description

Model Number	W"	D"	H"	Fabric Grade	List Price
Latimer Sofa OC017-30	70	28	35	SG 04.....\$	1978.00
				SG 05.....\$	2014.00
				SG 06.....\$	2049.00
				SG 08.....\$	2120.00
				SG 10.....\$	2190.00
				SG 12.....\$	2261.00
				SG 14.....\$	2332.00
				SG 16.....\$	2403.00
				SG 18.....\$	2473.00
				SG 20.....\$	2544.00
				SG 22.....\$	2615.00
				SG 24.....\$	2685.00
				SG 26.....\$	2756.00
				SG 28.....\$	2827.00
				SG 30.....\$	2897.00
				COM.....\$	1978.00

- Seat height: 18.75"
- Seat width: 60"
- Seat depth: 20"
- Arm height: 25"
- COM yardage: 7.1

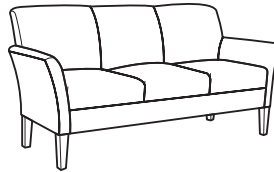

Maas Loveseat O2570-20Z	63	34.5	34.5	SG 04.....\$	1713.00
				SG 05.....\$	1751.00
				SG 06.....\$	1789.00
				SG 08.....\$	1865.00
				SG 10.....\$	1940.00
				SG 12.....\$	2016.00
				SG 14.....\$	2092.00
				SG 16.....\$	2167.00
				SG 18.....\$	2243.00
				SG 20.....\$	2319.00
				SG 22.....\$	2394.00
				SG 24.....\$	2470.00
				SG 26.....\$	2546.00
				SG 28.....\$	2621.00
				SG 30.....\$	2697.00
				COM.....\$	1713.00

- Seat height: 19.5"
- Seat width: 48"
- Seat depth: 22"
- Arm height: 27.25"
- COM yardage: 7.6

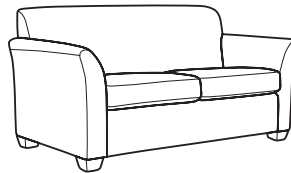

Meier Chair O2063-10	36.25	36.5	38	SG 04.....\$	1183.00
				SG 05.....\$	1208.00
				SG 06.....\$	1234.00
				SG 08.....\$	1285.00
				SG 10.....\$	1335.00
				SG 12.....\$	1386.00
				SG 14.....\$	1437.00
				SG 16.....\$	1488.00
				SG 18.....\$	1539.00
				SG 20.....\$	1589.00
				SG 22.....\$	1640.00
				SG 24.....\$	1691.00
				SG 26.....\$	1742.00
				SG 28.....\$	1792.00
				SG 30.....\$	1843.00
				COM.....\$	1183.00

- Seat height: 20.5"
- Seat width: 20"
- Seat depth: 22.5"
- Arm height: 25.5"
- COM yardage: 5.1

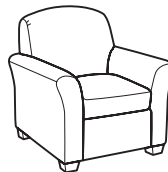

Meier Sofa O2063-30Z	76.5	34.25	37.75	SG 04.....\$	2271.00
				SG 05.....\$	2316.00
				SG 06.....\$	2361.00
				SG 08.....\$	2451.00
				SG 10.....\$	2540.00
				SG 12.....\$	2630.00
				SG 14.....\$	2719.00
				SG 16.....\$	2809.00
				SG 18.....\$	2899.00
				SG 20.....\$	2988.00
				SG 22.....\$	3078.00
				SG 24.....\$	3168.00
				SG 26.....\$	3257.00
				SG 28.....\$	3347.00
				SG 30.....\$	3436.00
				COM.....\$	2271.00

- Seat height: 19.75"
- Seat width: 60"
- Seat depth: 22"
- Arm height: 25.5"
- COM yardage: 9.0

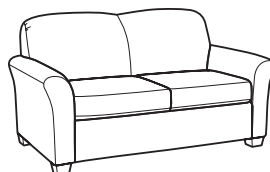



Seating Solutions

Made-to-Order Collections

Item Description	W"	D"	H"	Fabric Grade	List Price
Morse Armless Chair					
OC002-19	27	30.25	26.5	SG 04.....\$	858.00
				SG 05.....\$	872.00
				SG 06.....\$	886.00
				SG 08.....\$	914.00
				SG 10.....\$	942.00
				SG 12.....\$	970.00
				SG 14.....\$	998.00
				SG 16.....\$	1025.00
				SG 18.....\$	1053.00
				SG 20.....\$	1081.00
				SG 22.....\$	1109.00
				SG 24.....\$	1137.00
				SG 26.....\$	1165.00
				SG 28.....\$	1193.00
				SG 30.....\$	1221.00
				COM.....\$	868.00

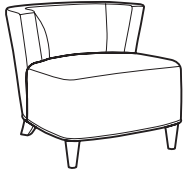

- Seat height: 18"
- Seat width: 27"
- Seat depth: 21.5"
- COM yardage: 2.8

Item Description	W"	D"	H"	Fabric Grade	List Price
Morse Armless Loveseat					
OC002-20	52	30.25	26.5	SG 04.....\$	1113.00
				SG 05.....\$	1134.00
				SG 06.....\$	1154.00
				SG 08.....\$	1195.00
				SG 10.....\$	1236.00
				SG 12.....\$	1277.00
				SG 14.....\$	1317.00
				SG 16.....\$	1358.00
				SG 18.....\$	1399.00
				SG 20.....\$	1440.00
				SG 22.....\$	1481.00
				SG 24.....\$	1521.00
				SG 26.....\$	1562.00
				SG 28.....\$	1603.00
				SG 30.....\$	1644.00
				COM.....\$	1113.00

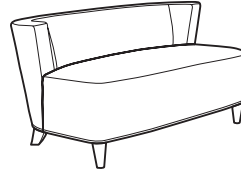

- Seat height: 18"
- Seat width: 52"
- Seat depth: 21.5"
- COM yardage: 4.1

Remington Lounge Chair					
OC021-10	28.5	34	34.25	SG 04.....\$	1506.00
				SG 05.....\$	1528.00
				SG 06.....\$	1549.00
				SG 08.....\$	1592.00
				SG 10.....\$	1635.00
				SG 12.....\$	1678.00
				SG 14.....\$	1721.00
				SG 16.....\$	1763.00
				SG 18.....\$	1806.00
				SG 20.....\$	1849.00
				SG 22.....\$	1892.00
				SG 24.....\$	1935.00
				SG 26.....\$	1977.00
				SG 28.....\$	2020.00
				SG 30.....\$	2063.00
				COM.....\$	1506.00



- Seat height: 18.25"
- Seat width: 21.5"
- Seat depth: 19.5"
- Arm height: 24.25"
- COM yardage: 4.3

Remington Sofa					
OC021-32	87.5	36	33	SG 04.....\$	2753.00
				SG 05.....\$	2805.00
				SG 06.....\$	2857.00
				SG 08.....\$	2962.00
				SG 10.....\$	3066.00
				SG 12.....\$	3171.00
				SG 14.....\$	3275.00
				SG 16.....\$	3380.00
				SG 18.....\$	3484.00
				SG 20.....\$	3589.00
				SG 22.....\$	3693.00
				SG 24.....\$	3798.00
				SG 26.....\$	3903.00
				SG 28.....\$	4007.00
				SG 30.....\$	4112.00
				COM.....\$	2753.00

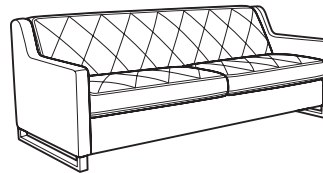

- Seat height: 19.5"
- Seat width: 79.75"
- Seat depth: 22.5"
- Arm height: 24.25"
- COM yardage: 10.5

Rohe Sofa					
OC051-32	94.5	36.75	34	SG 04.....\$	3010.00
				SG 05.....\$	3063.00
				SG 06.....\$	3116.00
				SG 08.....\$	3223.00
				SG 10.....\$	3329.00
				SG 12.....\$	3436.00
				SG 14.....\$	3542.00
				SG 16.....\$	3649.00
				SG 18.....\$	3755.00
				SG 20.....\$	3862.00
				SG 22.....\$	3968.00
				SG 24.....\$	4075.00
				SG 26.....\$	4181.00
				SG 28.....\$	4288.00
				SG 30.....\$	4394.00
				COM.....\$	3010.00

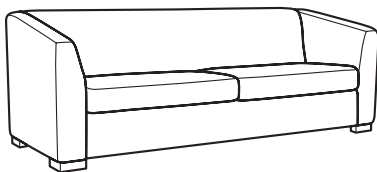

- Seat height: 19"
- Seat width: 79.5"
- Seat depth: 21.5"
- Arm height: 29"
- COM yardage: 10.7

Seating Solutions



FLEXSTEEL®
CONTRACT

Made-to-Order Accent Chairs

Item Description	W"	D"	H"	Fabric Grade	List Price
Aiken Chair					
OC009-10	32	30	34	SG 04.....\$	1196.00
				SG 05.....\$	1214.00
				SG 06.....\$	1232.00
				SG 08.....\$	1268.00
				SG 10.....\$	1304.00
				SG 12.....\$	1340.00
				SG 14.....\$	1375.00
				SG 16.....\$	1411.00
				SG 18.....\$	1447.00
				SG 20.....\$	1483.00
				SG 22.....\$	1519.00
				SG 24.....\$	1555.00
				SG 26.....\$	1590.00
				SG 28.....\$	1626.00
				SG 30.....\$	1662.00
				COM.....\$	1196.00

- Seat height: 19"
- Seat width: 25"
- Seat depth: 21"
- Arm height: 26"
- COM yardage: 3.6



Item Description	W"	D"	H"	Fabric Grade	List Price
Baird Chair					
OC005-10	30	29.5	32	SG 04.....\$	1064.00
				SG 05.....\$	1083.00
				SG 06.....\$	1101.00
				SG 08.....\$	1138.00
				SG 10.....\$	1175.00
				SG 12.....\$	1212.00
				SG 14.....\$	1248.00
				SG 16.....\$	1285.00
				SG 18.....\$	1322.00
				SG 20.....\$	1359.00
				SG 22.....\$	1396.00
				SG 24.....\$	1433.00
				SG 26.....\$	1470.00
				SG 28.....\$	1506.00
				SG 30.....\$	1543.00
				COM.....\$	1064.00

- Seat height: 19.25"
- Seat width: 23"
- Seat depth: 21"
- Arm height: 24.5"
- COM yardage: 3.7
- Tight seat cushion
- Rounded metal legs

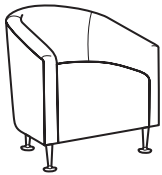

Item Description	W"	D"	H"	Fabric Grade	List Price
Benz Lounge Chair					
OC839-10	28.25	29	28	SG 04.....\$	986.00
				SG 05.....\$	995.00
				SG 06.....\$	1005.00
				SG 08.....\$	1025.00
				SG 10.....\$	1045.00
				SG 12.....\$	1065.00
				SG 14.....\$	1085.00
				SG 16.....\$	1105.00
				SG 18.....\$	1125.00
				SG 20.....\$	1145.00
				SG 22.....\$	1165.00
				SG 24.....\$	1185.00
				SG 26.....\$	1205.00
				SG 28.....\$	1224.00
				SG 30.....\$	1244.00
				COM.....\$	986.00

- Seat height: 18.5"
- Seat width: 22"
- Seat depth: 20"
- Arm height: 19.5"
- COM yardage: 3.2

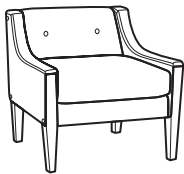

Item Description	W"	D"	H"	Fabric Grade	List Price
Carver Chair					
OC011-10LT	37.5	35	34.5	SG 04.....\$	2288.00
				SG 05.....\$	2309.00
				SG 06.....\$	2330.00
				SG 08.....\$	2371.00
				SG 10.....\$	2413.00
				SG 12.....\$	2455.00
				SG 14.....\$	2497.00
				SG 16.....\$	2539.00
				SG 18.....\$	2580.00
				SG 20.....\$	2622.00
				SG 22.....\$	2664.00
				SG 24.....\$	2706.00
				SG 26.....\$	2748.00
				SG 28.....\$	2790.00
				SG 30.....\$	2831.00
				COM.....\$	2288.00

- Seat height: 18"
- Seat width: 20.5"
- Seat depth: 20.5"
- Arm height: 27"
- COM yardage: 4.2
- Rotating tablet attached to right arm
- Legs available in brushed nickel only

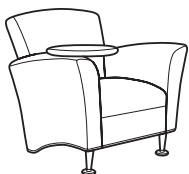

Item Description	W"	D"	H"	Fabric Grade	List Price
Armstrong Armless Chair					
OC003-19	27	35	37.75	SG 04.....\$	1260.00
				SG 05.....\$	1280.00
				SG 06.....\$	1301.00
				SG 08.....\$	1342.00
				SG 10.....\$	1382.00
				SG 12.....\$	1423.00
				SG 14.....\$	1464.00
				SG 16.....\$	1505.00
				SG 18.....\$	1546.00
				SG 20.....\$	1586.00
				SG 22.....\$	1627.00
				SG 24.....\$	1668.00
				SG 26.....\$	1709.00
				SG 28.....\$	1750.00
				SG 30.....\$	1791.00
				COM.....\$	1260.00

- Seat height: 19.25"
- Seat width: 27"
- Seat depth: 22"
- COM yardage: 4.1

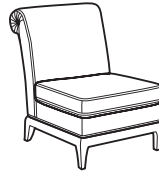

Item Description	W"	D"	H"	Fabric Grade	List Price
Banting Stackable Dining Chair					
OC010-10	23.25	25.25	36.75	SG 04.....\$	1023.00
				SG 05.....\$	1029.00
				SG 06.....\$	1034.00
				SG 08.....\$	1045.00
				SG 10.....\$	1056.00
				SG 12.....\$	1067.00
				SG 14.....\$	1078.00
				SG 16.....\$	1089.00
				SG 18.....\$	1100.00
				SG 20.....\$	1111.00
				SG 22.....\$	1122.00
				SG 24.....\$	1133.00
				SG 26.....\$	1144.00
				SG 28.....\$	1155.00
				SG 30.....\$	1166.00
				COM.....\$	1023.00

- Seat height: 20"
- Seat width: 19"
- Seat depth: 18.5"
- Arm height: 25.5"
- COM yardage: 1.1



Item Description	W"	D"	H"	Fabric Grade	List Price
Carver Chair					
OC011-10	34.5	33	34.5	SG 04.....\$	1181.00
				SG 05.....\$	1217.00
				SG 06.....\$	1253.00
				SG 08.....\$	1326.00
				SG 10.....\$	1399.00
				SG 12.....\$	1471.00
				SG 14.....\$	1544.00
				SG 16.....\$	1617.00
				SG 18.....\$	1689.00
				SG 20.....\$	1762.00
				SG 22.....\$	1835.00
				SG 24.....\$	1907.00
				SG 26.....\$	1980.00
				SG 28.....\$	2053.00
				SG 30.....\$	2126.00
				COM.....\$	1181.00

- Seat height: 18"
- Seat width: 20.5"
- Seat depth: 20.5"
- Arm height: 26.5"
- COM yardage: 7.3
- Legs available in brushed nickel only

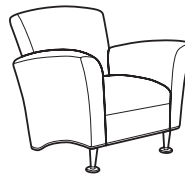

Item Description	W"	D"	H"	Fabric Grade	List Price
Carver Chair					
OC011-10RT	37.5	35	34.5	SG 04.....\$	2288.00
				SG 05.....\$	2309.00
				SG 06.....\$	2330.00
				SG 08.....\$	2371.00
				SG 10.....\$	2413.00
				SG 12.....\$	2455.00
				SG 14.....\$	2497.00
				SG 16.....\$	2539.00
				SG 18.....\$	2580.00
				SG 20.....\$	2622.00
				SG 22.....\$	2664.00
				SG 24.....\$	2706.00
				SG 26.....\$	2748.00
				SG 28.....\$	2790.00
				SG 30.....\$	2831.00
				COM.....\$	2288.00

- Seat height: 18"
- Seat width: 20.5"
- Seat depth: 20.5"
- Arm height: 27"
- COM yardage: 4.2
- Rotating tablet attached to left arm
- Legs available in brushed nickel only

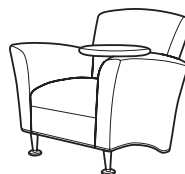



Seating Solutions

Made-to-Order Accent Chairs

Item Description	W"	D"	H"	Fabric Grade	List Price
Cowen Bar-Height Stool				SG 04.....\$	980.00
OC914-16	18	21	40	SG 05.....\$	987.00
				SG 06.....\$	994.00
				SG 08.....\$	1008.00
				SG 10.....\$	1022.00
				SG 12.....\$	1036.00
				SG 14.....\$	1050.00
				SG 16.....\$	1064.00
				SG 18.....\$	1078.00
				SG 20.....\$	1092.00
				SG 22.....\$	1106.00
				SG 24.....\$	1120.00
				SG 26.....\$	1133.00
				SG 28.....\$	1147.00
				SG 30.....\$	1161.00
				COM.....\$	980.00



- Seat height: 30"
- Seat width: 18"
- Seat depth: 20"
- COM yardage: 1.4

Item Description	W"	D"	H"	Fabric Grade	List Price
Cowen Armless Side Chair				SG 04.....\$	1094.00
OC914-19	17.75	22	29	SG 05.....\$	1102.00
				SG 06.....\$	1110.00
				SG 08.....\$	1126.00
				SG 10.....\$	1142.00
				SG 12.....\$	1158.00
				SG 14.....\$	1174.00
				SG 16.....\$	1190.00
				SG 18.....\$	1206.00
				SG 20.....\$	1222.00
				SG 22.....\$	1237.00
				SG 24.....\$	1253.00
				SG 26.....\$	1269.00
				SG 28.....\$	1285.00
				SG 30.....\$	1301.00
				COM.....\$	1094.00



- Seat height: 29"
- Seat width: 18"
- Seat depth: 18"
- COM yardage: 1.6

Crum Stool				SG 04.....\$	700.00
OC043-16	17	21.25	44.75	SG 05.....\$	703.00
				SG 06.....\$	705.00
				SG 08.....\$	710.00
				SG 10.....\$	715.00
				SG 12.....\$	720.00
				SG 14.....\$	725.00
				SG 16.....\$	730.00
				SG 18.....\$	735.00
				SG 20.....\$	740.00
				SG 22.....\$	745.00
				SG 24.....\$	750.00
				SG 26.....\$	755.00
				SG 28.....\$	760.00
				SG 30.....\$	765.00
				COM.....\$	700.00



- Seat height: 31.75"
- Seat width: 17"
- Seat depth: 16.5"
- COM yardage: 0.5

Crum Armless Dining Chair				SG 04.....\$	588.00
OC043-19	17	21.25	35	SG 05.....\$	590.00
				SG 06.....\$	593.00
				SG 08.....\$	597.00
				SG 10.....\$	602.00
				SG 12.....\$	607.00
				SG 14.....\$	612.00
				SG 16.....\$	617.00
				SG 18.....\$	622.00
				SG 20.....\$	627.00
				SG 22.....\$	632.00
				SG 24.....\$	637.00
				SG 26.....\$	642.00
				SG 28.....\$	647.00
				SG 30.....\$	652.00
				COM.....\$	588.00



- Seat height: 19.5"
- Seat width: 17"
- Seat depth: 16.5"
- COM yardage: 0.5

Eames Dining Chair				SG 04.....\$	795.00
O1038-10	23	24.5	35.75	SG 05.....\$	801.00
				SG 06.....\$	806.00
				SG 08.....\$	817.00
				SG 10.....\$	828.00
				SG 12.....\$	839.00
				SG 14.....\$	850.00
				SG 16.....\$	861.00
				SG 18.....\$	872.00
				SG 20.....\$	883.00
				SG 22.....\$	894.00
				SG 24.....\$	905.00
				SG 26.....\$	916.00
				SG 28.....\$	927.00
				SG 30.....\$	938.00
				COM.....\$	792.00

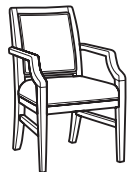

- Seat height: 19.25"
- Seat width: 19"
- Seat depth: 18.5"
- Arm height: 26.5"
- COM yardage: 1.1

Eames Dining Chair				SG 04.....\$	1261.00
O1038-19	20.25	24.5	35.75	SG 05.....\$	1267.00
				SG 06.....\$	1272.00
				SG 08.....\$	1283.00
				SG 10.....\$	1294.00
				SG 12.....\$	1305.00
				SG 14.....\$	1316.00
				SG 16.....\$	1327.00
				SG 18.....\$	1338.00
				SG 20.....\$	1349.00
				SG 22.....\$	1360.00
				SG 24.....\$	1371.00
				SG 26.....\$	1382.00
				SG 28.....\$	1393.00
				SG 30.....\$	1404.00
				COM.....\$	1261.00



- Seat height: 19.25"
- Seat width: 20.5"
- Seat depth: 18.5"
- COM yardage: 1.1

Eames Dining Chair				SG 04.....\$	865.00
O1038-102	23	24.5	35.75	SG 05.....\$	871.00
				SG 06.....\$	876.00
				SG 08.....\$	887.00
				SG 10.....\$	898.00
				SG 12.....\$	909.00
				SG 14.....\$	920.00
				SG 16.....\$	931.00
				SG 18.....\$	942.00
				SG 20.....\$	953.00
				SG 22.....\$	964.00
				SG 24.....\$	975.00
				SG 26.....\$	986.00
				SG 28.....\$	997.00
				SG 30.....\$	1008.00
				COM.....\$	865.00



- Seat height: 19.25"
- Seat width: 19"
- Seat depth: 18.5"
- Arm height: 26.5"
- COM yardage: 1.1

Eastman Chair				SG 04.....\$	1185.00
OC008-10	33	36	37	SG 05.....\$	1207.00
				SG 06.....\$	1229.00
				SG 08.....\$	1273.00
				SG 10.....\$	1317.00
				SG 12.....\$	1361.00
				SG 14.....\$	1404.00
				SG 16.....\$	1448.00
				SG 18.....\$	1492.00
				SG 20.....\$	1536.00
				SG 22.....\$	1580.00
				SG 24.....\$	1624.00
				SG 26.....\$	1667.00
				SG 28.....\$	1711.00
				SG 30.....\$	1755.00
				COM.....\$	1185.00

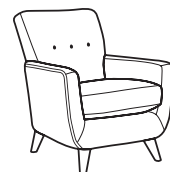

- Seat height: 20"
- Seat width: 23"
- Seat depth: 21"
- Arm height: 25"
- COM yardage: 4.4

Seating Solutions



FLEX STEEL®
CONTRACT

Made-to-Order Accent Chairs

Item Description

Model Number	W"	D"	H"	Fabric Grade	List Price
Epperson Armless Dining Chair OC040-19	18.25	21.5	36	SG 04.....\$	1012.00
				SG 05.....\$	1021.00
				SG 06.....\$	1030.00
				SG 08.....\$	1048.00
				SG 10.....\$	1066.00
				SG 12.....\$	1083.00
				SG 14.....\$	1101.00
				SG 16.....\$	1119.00
				SG 18.....\$	1137.00
				SG 20.....\$	1155.00
				SG 22.....\$	1173.00
				SG 24.....\$	1191.00
				SG 26.....\$	1209.00
				SG 28.....\$	1227.00
				SG 30.....\$	1245.00
				COM.....\$	1012.00

- Seat height: 21"
- Seat width: 18.25"
- Seat depth: 17"
- COM yardage: 1.8



Fox Dining Chair

Model Number	W"	D"	H"	Fabric Grade	List Price
Fox Dining Chair OC050-10	26.5	25	37.5	SG 04.....\$	812.00
				SG 05.....\$	818.00
				SG 06.....\$	824.00
				SG 08.....\$	836.00
				SG 10.....\$	848.00
				SG 12.....\$	860.00
				SG 14.....\$	872.00
				SG 16.....\$	884.00
				SG 18.....\$	896.00
				SG 20.....\$	908.00
				SG 22.....\$	920.00
				SG 24.....\$	932.00
				SG 26.....\$	944.00
				SG 28.....\$	956.00
				SG 30.....\$	968.00
				COM.....\$	812.00

- Seat height: 18.75"
- Seat width: 20"
- Seat depth: 18.5"
- Arm height: 24.25"
- COM yardage: 1.2



Franklin Dining Chair

Model Number	W"	D"	H"	Fabric Grade	List Price
Franklin Dining Chair OC006-10	25	25	37	SG 04.....\$	929.00
				SG 05.....\$	936.00
				SG 06.....\$	943.00
				SG 08.....\$	957.00
				SG 10.....\$	971.00
				SG 12.....\$	985.00
				SG 14.....\$	999.00
				SG 16.....\$	1012.00
				SG 18.....\$	1026.00
				SG 20.....\$	1040.00
				SG 22.....\$	1054.00
				SG 24.....\$	1068.00
				SG 26.....\$	1082.00
				SG 28.....\$	1096.00
				SG 30.....\$	1110.00
				COM.....\$	929.00

- Seat height: 18.75"
- Seat width: 19"
- Seat depth: 18"
- Arm height: 25"
- COM yardage: 1.4



Galton Tablet Arm Chair

Model Number	W"	D"	H"	Fabric Grade	List Price
Galton Tablet Arm Chair O2677-10RT	32	30	31.75	SG 04.....\$	1124.00
				SG 05.....\$	1141.00
				SG 06.....\$	1159.00
				SG 08.....\$	1194.00
				SG 10.....\$	1229.00
				SG 12.....\$	1263.00
				SG 14.....\$	1298.00
				SG 16.....\$	1333.00
				SG 18.....\$	1368.00
				SG 20.....\$	1403.00
				SG 22.....\$	1438.00
				SG 24.....\$	1472.00
				SG 26.....\$	1507.00
				SG 28.....\$	1542.00
				SG 30.....\$	1577.00
				COM.....\$	1124.00

- Seat height: 19"
- Seat width: 20.5"
- Seat depth: 21.25"
- Arm height: 24.5"
- COM yardage: 3.5



Item Description

Model Number	W"	D"	H"	Fabric Grade	List Price
Finley Armless Dining Chair OC047-19	23.75	27.5	37.75	SG 04.....\$	929.00
				SG 05.....\$	941.00
				SG 06.....\$	953.00
				SG 08.....\$	977.00
				SG 10.....\$	1001.00
				SG 12.....\$	1025.00
				SG 14.....\$	1049.00
				SG 16.....\$	1073.00
				SG 18.....\$	1097.00
				SG 20.....\$	1121.00
				SG 22.....\$	1144.00
				SG 24.....\$	1168.00
				SG 26.....\$	1192.00
				SG 28.....\$	1216.00
				SG 30.....\$	1240.00
				COM.....\$	929.00

- Seat height: 20"
- Seat width: 23.75"
- Seat depth: 20"
- COM yardage: 2.4



Fox Armless Dining Chair

Model Number	W"	D"	H"	Fabric Grade	List Price
Fox Armless Dining Chair OC050-19	24.5	25	37.5	SG 04.....\$	810.00
				SG 05.....\$	815.00
				SG 06.....\$	821.00
				SG 08.....\$	832.00
				SG 10.....\$	843.00
				SG 12.....\$	853.00
				SG 14.....\$	864.00
				SG 16.....\$	875.00
				SG 18.....\$	886.00
				SG 20.....\$	897.00
				SG 22.....\$	908.00
				SG 24.....\$	919.00
				SG 26.....\$	930.00
				SG 28.....\$	941.00
				SG 30.....\$	952.00
				COM.....\$	810.00

- Seat height: 19.75"
- Seat width: 22"
- Seat depth: 19.5"
- COM yardage: 1.1



Galton Tablet Arm Chair

Model Number	W"	D"	H"	Fabric Grade	List Price
Galton Tablet Arm Chair O2677-10LT	32	30	31.75	SG 04.....\$	1124.00
				SG 05.....\$	1141.00
				SG 06.....\$	1159.00
				SG 08.....\$	1194.00
				SG 10.....\$	1229.00
				SG 12.....\$	1263.00
				SG 14.....\$	1298.00
				SG 16.....\$	1333.00
				SG 18.....\$	1368.00
				SG 20.....\$	1403.00
				SG 22.....\$	1438.00
				SG 24.....\$	1472.00
				SG 26.....\$	1507.00
				SG 28.....\$	1542.00
				SG 30.....\$	1577.00
				COM.....\$	1124.00

- Seat height: 19"
- Seat width: 20.5"
- Seat depth: 21.25"
- Arm height: 24.5"
- COM yardage: 3.5



Hooke Armless Dining Chair

Model Number	W"	D"	H"	Fabric Grade	List Price
Hooke Armless Dining Chair OC044-19	19	24	35.5	SG 04.....\$	902.00
				SG 05.....\$	909.00
				SG 06.....\$	917.00
				SG 08.....\$	931.00
				SG 10.....\$	946.00
				SG 12.....\$	961.00
				SG 14.....\$	976.00
				SG 16.....\$	991.00
				SG 18.....\$	1006.00
				SG 20.....\$	1021.00
				SG 22.....\$	1036.00
				SG 24.....\$	1051.00
				SG 26.....\$	1066.00
				SG 28.....\$	1081.00
				SG 30.....\$	1096.00
				COM.....\$	902.00

- Seat height: 19.5"
- Seat width: 19"
- Seat depth: 18.5"
- COM yardage: 1.5
- Metal handle available in brushed nickel only





Seating Solutions

Made-to-Order Accent Chairs

Item Description	W"	D"	H"	Fabric Grade	List Price
Hopper Lounge Chair OC019-10	28.5	27.5	33.5	SG 04.....\$	1115.00
				SG 05.....\$	1128.00
				SG 06.....\$	1141.00
				SG 08.....\$	1167.00
				SG 10.....\$	1193.00
				SG 12.....\$	1219.00
				SG 14.....\$	1245.00
				SG 16.....\$	1271.00
				SG 18.....\$	1296.00
				SG 20.....\$	1322.00
				SG 22.....\$	1348.00
				SG 24.....\$	1374.00
				SG 26.....\$	1400.00
				SG 28.....\$	1426.00
				SG 30.....\$	1452.00
				COM.....\$	1115.00



- Seat height: 18"
- Seat width: 20.5"
- Seat depth: 19.5"
- Arm height: 23.5"
- COM yardage: 2.6
- Metal ferrules available in brushed brass only

Item Description	W"	D"	H"	Fabric Grade	List Price
Lamarr Dining Chair OC012-10	24	24.5	30	SG 04.....\$	947.00
				SG 05.....\$	956.00
				SG 06.....\$	965.00
				SG 08.....\$	983.00
				SG 10.....\$	1001.00
				SG 12.....\$	1019.00
				SG 14.....\$	1037.00
				SG 16.....\$	1055.00
				SG 18.....\$	1073.00
				SG 20.....\$	1091.00
				SG 22.....\$	1109.00
				SG 24.....\$	1126.00
				SG 26.....\$	1144.00
				SG 28.....\$	1162.00
				SG 30.....\$	1180.00
				COM.....\$	947.00

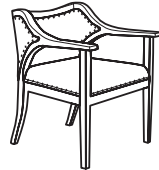

- Seat height: 18.5"
- Seat width: 20"
- Seat depth: 18.5"
- Arm height: 25"
- COM yardage: 1.8
- Nailhead trim standard

Macmillan Chair OC024-19	22	28.5	32	SG 04.....\$	1389.00
				SG 05.....\$	1400.00
				SG 06.....\$	1411.00
				SG 08.....\$	1433.00
				SG 10.....\$	1455.00
				SG 12.....\$	1477.00
				SG 14.....\$	1499.00
				SG 16.....\$	1521.00
				SG 18.....\$	1543.00
				SG 20.....\$	1565.00
				SG 22.....\$	1587.00
				SG 24.....\$	1609.00
				SG 26.....\$	1630.00
				SG 28.....\$	1652.00
				SG 30.....\$	1674.00
				COM.....\$	1389.00



- Seat height: 18"
- Seat width: 22"
- COM yardage: 2.2

Marx Chair OC001-10	31	31	32	SG 04.....\$	1481.00
				SG 05.....\$	1502.00
				SG 06.....\$	1523.00
				SG 08.....\$	1565.00
				SG 10.....\$	1607.00
				SG 12.....\$	1649.00
				SG 14.....\$	1691.00
				SG 16.....\$	1732.00
				SG 18.....\$	1774.00
				SG 20.....\$	1816.00
				SG 22.....\$	1858.00
				SG 24.....\$	1900.00
				SG 26.....\$	1941.00
				SG 28.....\$	1983.00
				SG 30.....\$	2025.00
				COM.....\$	1481.00

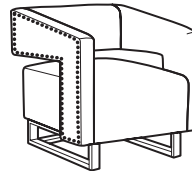

- Seat height: 19"
- Seat width: 22.5"
- Seat depth: 24"
- Arm height: 27.5"
- COM yardage: 4.2
- Nailhead trim standard

Moneo Dining Chair O1036-10	22	26.5	35.5	SG 04.....\$	805.00
				SG 05.....\$	810.00
				SG 06.....\$	816.00
				SG 08.....\$	827.00
				SG 10.....\$	838.00
				SG 12.....\$	849.00
				SG 14.....\$	859.00
				SG 16.....\$	870.00
				SG 18.....\$	881.00
				SG 20.....\$	892.00
				SG 22.....\$	903.00
				SG 24.....\$	914.00
				SG 26.....\$	925.00
				SG 28.....\$	936.00
				SG 30.....\$	947.00
				COM.....\$	805.00



- Seat height: 18.5"
- Seat width: 19"
- Seat depth: 18.5"
- Arm height: 25.5"
- COM yardage: 1.1

Moneo Dining Chair O1036-19	20.5	26.5	35.5	SG 04.....\$	986.00
				SG 05.....\$	991.00
				SG 06.....\$	997.00
				SG 08.....\$	1008.00
				SG 10.....\$	1019.00
				SG 12.....\$	1029.00
				SG 14.....\$	1040.00
				SG 16.....\$	1051.00
				SG 18.....\$	1062.00
				SG 20.....\$	1073.00
				SG 22.....\$	1084.00
				SG 24.....\$	1095.00
				SG 26.....\$	1106.00
				SG 28.....\$	1117.00
				SG 30.....\$	1128.00
				COM.....\$	986.00



- Seat height: 18.5"
- Seat width: 19"
- Seat depth: 18.5"
- COM yardage: 1.1

Moneo Dining Chair O1036-102	22	26.5	35.5	SG 04.....\$	846.00
				SG 05.....\$	852.00
				SG 06.....\$	857.00
				SG 08.....\$	868.00
				SG 10.....\$	879.00
				SG 12.....\$	890.00
				SG 14.....\$	901.00
				SG 16.....\$	912.00
				SG 18.....\$	923.00
				SG 20.....\$	934.00
				SG 22.....\$	945.00
				SG 24.....\$	956.00
				SG 26.....\$	967.00
				SG 28.....\$	978.00
				SG 30.....\$	989.00
				COM.....\$	846.00



- Seat height: 18.5"
- Seat width: 19"
- Seat depth: 18.5"
- Arm height: 25.5"
- COM yardage: 1.1

Montagu Dining Chair OC046-10	24	24.5	37	SG 04.....\$	1180.00
				SG 05.....\$	1188.00
				SG 06.....\$	1196.00
				SG 08.....\$	1212.00
				SG 10.....\$	1228.00
				SG 12.....\$	1244.00
				SG 14.....\$	1260.00
				SG 16.....\$	1276.00
				SG 18.....\$	1292.00
				SG 20.....\$	1308.00
				SG 22.....\$	1324.00
				SG 24.....\$	1340.00
				SG 26.....\$	1356.00
				SG 28.....\$	1372.00
				SG 30.....\$	1387.00
				COM.....\$	1180.00



- Seat height: 18.75"
- Seat width: 20"
- Seat depth: 19"
- Arm height: 26.5"
- COM yardage: 1.6

Seating Solutions



FLEXSTEEL®
CONTRACT

Made-to-Order Accent Chairs

Item Description

Model Number	W"	D"	H"	Fabric Grade	List Price
Montagu Dining Chair				SG 04.....	\$ 1280.00
OC046-10WR	24	24.5	37	SG 05.....	\$ 1286.00
				SG 06.....	\$ 1293.00
				SG 08.....	\$ 1305.00
				SG 10.....	\$ 1318.00
				SG 12.....	\$ 1331.00
				SG 14.....	\$ 1344.00
				SG 16.....	\$ 1357.00
				SG 18.....	\$ 1370.00
				SG 20.....	\$ 1383.00
				SG 22.....	\$ 1396.00
				SG 24.....	\$ 1409.00
				SG 26.....	\$ 1422.00
				SG 28.....	\$ 1435.00
				SG 30.....	\$ 1448.00
				COM.....	\$ 1280.00

- Seat height: 18.75"
- Seat width: 20"
- Seat depth: 19"
- Arm height: 26.5"
- COM yardage: 1.3



Montagu Dining Chair

OC046-102H	24	24.5	37	SG 04.....	\$ 1308.00
				SG 05.....	\$ 1316.00
				SG 06.....	\$ 1324.00
				SG 08.....	\$ 1340.00
				SG 10.....	\$ 1356.00
				SG 12.....	\$ 1372.00
				SG 14.....	\$ 1388.00
				SG 16.....	\$ 1404.00
				SG 18.....	\$ 1420.00
				SG 20.....	\$ 1436.00
				SG 22.....	\$ 1452.00
				SG 24.....	\$ 1468.00
				SG 26.....	\$ 1484.00
				SG 28.....	\$ 1500.00
				SG 30.....	\$ 1515.00
				COM.....	\$ 1308.00

- Seat height: 18.75"
- Seat width: 20"
- Seat depth: 19"
- Arm height: 26.5"
- COM yardage: 1.6



Otto Dining Chair

OC022-10	23	24	31	SG 04.....	\$ 1271.00
				SG 05.....	\$ 1282.00
				SG 06.....	\$ 1293.00
				SG 08.....	\$ 1315.00
				SG 10.....	\$ 1337.00
				SG 12.....	\$ 1358.00
				SG 14.....	\$ 1380.00
				SG 16.....	\$ 1402.00
				SG 18.....	\$ 1424.00
				SG 20.....	\$ 1446.00
				SG 22.....	\$ 1468.00
				SG 24.....	\$ 1490.00
				SG 26.....	\$ 1512.00
				SG 28.....	\$ 1534.00
				SG 30.....	\$ 1556.00
				COM.....	\$ 1271.00

- Seat height: 19.25"
- Seat width: 20"
- Seat depth: 18"
- Arm height: 25"
- COM yardage: 2.2

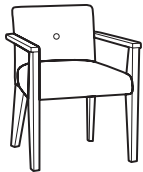

Sandford Stool

OC041-16	20.5	23	43.5	SG 04.....	\$ 1134.00
				SG 05.....	\$ 1141.00
				SG 06.....	\$ 1148.00
				SG 08.....	\$ 1162.00
				SG 10.....	\$ 1176.00
				SG 12.....	\$ 1190.00
				SG 14.....	\$ 1204.00
				SG 16.....	\$ 1218.00
				SG 18.....	\$ 1232.00
				SG 20.....	\$ 1245.00
				SG 22.....	\$ 1259.00
				SG 24.....	\$ 1273.00
				SG 26.....	\$ 1287.00
				SG 28.....	\$ 1301.00
				SG 30.....	\$ 1315.00
				COM.....	\$ 1134.00

- Seat height: 31.75"
- Seat width: 20.5"
- Seat depth: 18.5"
- COM yardage: 1.4



Item Description

Model Number	W"	D"	H"	Fabric Grade	List Price
Montagu Dining Chair				SG 04.....	\$ 1232.00
OC046-102	24	24.5	37	SG 05.....	\$ 1240.00
				SG 06.....	\$ 1248.00
				SG 08.....	\$ 1264.00
				SG 10.....	\$ 1280.00
				SG 12.....	\$ 1296.00
				SG 14.....	\$ 1312.00
				SG 16.....	\$ 1328.00
				SG 18.....	\$ 1344.00
				SG 20.....	\$ 1360.00
				SG 22.....	\$ 1376.00
				SG 24.....	\$ 1392.00
				SG 26.....	\$ 1408.00
				SG 28.....	\$ 1423.00
				SG 30.....	\$ 1439.00
				COM.....	\$ 1232.00

- Seat height: 18.75"
- Seat width: 20"
- Seat depth: 19"
- Arm height: 26.5"
- COM yardage: 1.6



Nobel Chair

OC025-10	33	32	32.25	SG 04.....	\$ 1484.00
				SG 05.....	\$ 1504.00
				SG 06.....	\$ 1523.00
				SG 08.....	\$ 1562.00
				SG 10.....	\$ 1601.00
				SG 12.....	\$ 1640.00
				SG 14.....	\$ 1678.00
				SG 16.....	\$ 1717.00
				SG 18.....	\$ 1756.00
				SG 20.....	\$ 1795.00
				SG 22.....	\$ 1834.00
				SG 24.....	\$ 1872.00
				SG 26.....	\$ 1911.00
				SG 28.....	\$ 1950.00
				SG 30.....	\$ 1989.00
				COM.....	\$ 1484.00

- Seat height: 19.5"
- Seat width: 25"
- Seat depth: 22.5"
- Arm height: 24"
- COM yardage: 3.9



Philo Chair

OC049-10	28.25	27.75	37.25	SG 04.....	\$ 1208.00
				SG 05.....	\$ 1223.00
				SG 06.....	\$ 1237.00
				SG 08.....	\$ 1266.00
				SG 10.....	\$ 1295.00
				SG 12.....	\$ 1324.00
				SG 14.....	\$ 1353.00
				SG 16.....	\$ 1381.00
				SG 18.....	\$ 1410.00
				SG 20.....	\$ 1439.00
				SG 22.....	\$ 1468.00
				SG 24.....	\$ 1497.00
				SG 26.....	\$ 1526.00
				SG 28.....	\$ 1555.00
				SG 30.....	\$ 1584.00
				COM.....	\$ 1208.00

- Seat height: 20.25"
- Seat width: 20.5"
- Seat depth: 18"
- Arm height: 24.5"
- COM yardage: 2.9



Sandford Armless Dining Chair

OC041-19	20.5	23.5	32	SG 04.....	\$ 876.00
				SG 05.....	\$ 884.00
				SG 06.....	\$ 891.00
				SG 08.....	\$ 906.00
				SG 10.....	\$ 921.00
				SG 12.....	\$ 936.00
				SG 14.....	\$ 951.00
				SG 16.....	\$ 966.00
				SG 18.....	\$ 981.00
				SG 20.....	\$ 996.00
				SG 22.....	\$ 1011.00
				SG 24.....	\$ 1025.00
				SG 26.....	\$ 1040.00
				SG 28.....	\$ 1055.00
				SG 30.....	\$ 1070.00
				COM.....	\$ 876.00

- Seat height: 19"
- Seat width: 20.5"
- Seat depth: 19.5"
- COM yardage: 1.5





Seating Solutions

Made-to-Order Accent Chairs

Item Description						Item Description					
Model Number	W"	D"	H"	Fabric Grade	List Price	Model Number	W"	D"	H"	Fabric Grade	List Price
Sholes Dining Chair						Sholes Armless Dining Chair					
OC048-10	23.75	23	36.5	SG 04.....	\$ 796.00	OC048-19	20.5	23	36.5	SG 04.....	\$ 731.00
				SG 05.....	\$ 804.00					SG 05.....	\$ 739.00
				SG 06.....	\$ 812.00					SG 06.....	\$ 747.00
				SG 08.....	\$ 828.00					SG 08.....	\$ 763.00
				SG 10.....	\$ 843.00					SG 10.....	\$ 779.00
				SG 12.....	\$ 859.00					SG 12.....	\$ 795.00
				SG 14.....	\$ 875.00					SG 14.....	\$ 811.00
				SG 16.....	\$ 891.00					SG 16.....	\$ 827.00
				SG 18.....	\$ 907.00					SG 18.....	\$ 843.00
				SG 20.....	\$ 923.00					SG 20.....	\$ 859.00
				SG 22.....	\$ 939.00					SG 22.....	\$ 874.00
				SG 24.....	\$ 955.00					SG 24.....	\$ 890.00
				SG 26.....	\$ 971.00					SG 26.....	\$ 906.00
				SG 28.....	\$ 987.00					SG 28.....	\$ 922.00
				SG 30.....	\$ 1003.00					SG 30.....	\$ 938.00
				COM.....	\$ 796.00					COM.....	\$ 731.00



Stine Lounge Chair					
OC016-10	32	34	43	SG 04.....	\$ 1586.00
				SG 05.....	\$ 1616.00
				SG 06.....	\$ 1645.00
				SG 08.....	\$ 1704.00
				SG 10.....	\$ 1763.00
				SG 12.....	\$ 1821.00
				SG 14.....	\$ 1880.00
				SG 16.....	\$ 1939.00
				SG 18.....	\$ 1998.00
				SG 20.....	\$ 2056.00
				SG 22.....	\$ 2115.00
				SG 24.....	\$ 2174.00
				SG 26.....	\$ 2233.00
				SG 28.....	\$ 2291.00
				SG 30.....	\$ 2350.00
				COM.....	\$ 1586.00

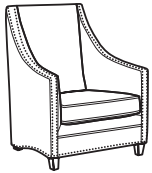

- Seat height: 18.5"
- Seat width: 20.5"
- Seat depth: 18.5"
- Arm height: 26"
- COM yardage: 1.6

- Seat height: 18.5"
- Seat width: 20.5"
- Seat depth: 18.5"
- COM yardage: 1.6

- Seat height: 19"
- Seat width: 24.5"
- Seat depth: 22"
- Arm height: 25"
- COM yardage: 5.9
- Nailhead trim standard

Seating Solutions



FLEXSTEEL®
CONTRACT

Made-to-Order Ottomans & Benches

Item Description

Model Number	W"	D"	H"	Fabric Grade	List Price
Alva Ottoman OC036-08	16.5	16.5	19	SG 04.....\$	377.00
				SG 05.....\$	384.00
				SG 06.....\$	391.00
				SG 08.....\$	405.00
				SG 10.....\$	419.00
				SG 12.....\$	433.00
				SG 14.....\$	446.00
				SG 16.....\$	460.00
				SG 18.....\$	474.00
				SG 20.....\$	488.00
				SG 22.....\$	502.00
				SG 24.....\$	516.00
				SG 26.....\$	530.00
				SG 28.....\$	544.00
				SG 30.....\$	558.00
				COM.....\$	377.00

• COM yardage: 1.4

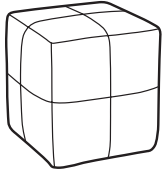

Bell Ottoman OC018-08D	16	18	18\$	800.00
---------------------------	----	----	----	---------	--------

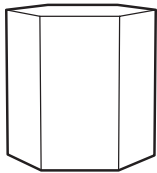

Bell Ottoman OC018-08G	16	18	18\$	696.00
---------------------------	----	----	----	---------	--------

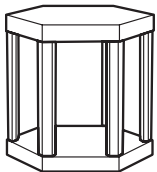

Borda Bench OC033-21	52	16	18.5	SG 04.....\$	988.00
				SG 05.....\$	997.00
				SG 06.....\$	1005.00
				SG 08.....\$	1022.00
				SG 10.....\$	1039.00
				SG 12.....\$	1056.00
				SG 14.....\$	1073.00
				SG 16.....\$	1090.00
				SG 18.....\$	1107.00
				SG 20.....\$	1124.00
				SG 22.....\$	1140.00
				SG 24.....\$	1157.00
				SG 26.....\$	1174.00
				SG 28.....\$	1191.00
				SG 30.....\$	1208.00
				COM.....\$	988.00

• COM yardage: 1.7
• Base available in brushed nickel only

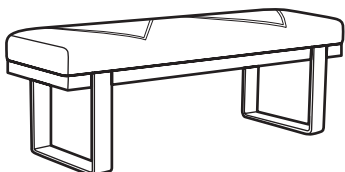

Item Description

Model Number	W"	D"	H"	Fabric Grade	List Price
Alvar Ottoman OC726-08	24	21	17	SG 04.....\$	555.00
				SG 05.....\$	562.00
				SG 06.....\$	569.00
				SG 08.....\$	583.00
				SG 10.....\$	597.00
				SG 12.....\$	611.00
				SG 14.....\$	625.00
				SG 16.....\$	639.00
				SG 18.....\$	653.00
				SG 20.....\$	667.00
				SG 22.....\$	681.00
				SG 24.....\$	695.00
				SG 26.....\$	709.00
				SG 28.....\$	723.00
				SG 30.....\$	737.00
				COM.....\$	555.00

• COM yardage: 1.4

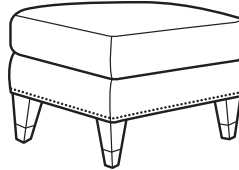

Bell Ottoman OC018-08E	16	18	18	SG 04.....\$	403.00
				SG 05.....\$	410.00
				SG 06.....\$	417.00
				SG 08.....\$	431.00
				SG 10.....\$	445.00
				SG 12.....\$	459.00
				SG 14.....\$	473.00
				SG 16.....\$	487.00
				SG 18.....\$	501.00
				SG 20.....\$	514.00
				SG 22.....\$	528.00
				SG 24.....\$	542.00
				SG 26.....\$	556.00
				SG 28.....\$	570.00
				SG 30.....\$	584.00
				COM.....\$	403.00

• COM yardage: 1.4
• Glides
• Works as a stand-alone piece or in a group with other Bell Ottomans

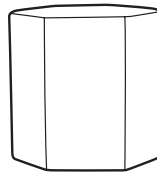

Blair Bench OC027-21	48	18	22	SG 04.....\$	1343.00
				SG 05.....\$	1363.00
				SG 06.....\$	1383.00
				SG 08.....\$	1422.00
				SG 10.....\$	1462.00
				SG 12.....\$	1502.00
				SG 14.....\$	1542.00
				SG 16.....\$	1582.00
				SG 18.....\$	1621.00
				SG 20.....\$	1661.00
				SG 22.....\$	1701.00
				SG 24.....\$	1741.00
				SG 26.....\$	1781.00
				SG 28.....\$	1821.00
				SG 30.....\$	1860.00
				COM.....\$	1343.00

• Seat height: 19.5"
• Seat width: 30"
• Seat depth: 18"
• Arm height: 22.25"
• COM yardage: 4.0

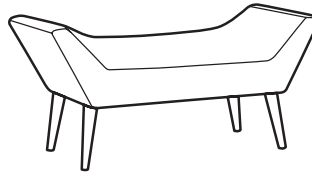

Colt Ottoman OC007-08	27	22	18	SG 04.....\$	455.00
				SG 05.....\$	464.00
				SG 06.....\$	473.00
				SG 08.....\$	491.00
				SG 10.....\$	509.00
				SG 12.....\$	526.00
				SG 14.....\$	544.00
				SG 16.....\$	562.00
				SG 18.....\$	580.00
				SG 20.....\$	598.00
				SG 22.....\$	616.00
				SG 24.....\$	634.00
				SG 26.....\$	652.00
				SG 28.....\$	670.00
				SG 30.....\$	688.00
				COM.....\$	455.00

• COM yardage: 1.8

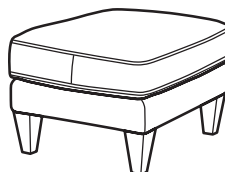



Seating Solutions

Made-to-Order Ottomans & Benches

Item Description	W"	D"	H"	Fabric Grade	List Price
Cusa Storage Ottoman OC034-095K	19	19	19	SG 04.....\$	578.00
				SG 05.....\$	585.00
				SG 06.....\$	593.00
				SG 08.....\$	607.00
				SG 10.....\$	622.00
				SG 12.....\$	637.00
				SG 14.....\$	652.00
				SG 16.....\$	667.00
				SG 18.....\$	682.00
				SG 20.....\$	697.00
				SG 22.....\$	712.00
				SG 24.....\$	727.00
				SG 26.....\$	742.00
				SG 28.....\$	757.00
				SG 30.....\$	772.00
				COM.....\$	578.00

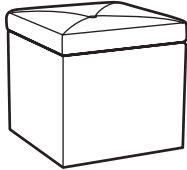

Elion Ottoman OC030-08T	16	16	21	SG 04.....\$	457.00
				SG 05.....\$	466.00
				SG 06.....\$	475.00
				SG 08.....\$	493.00
				SG 10.....\$	511.00
				SG 12.....\$	529.00
				SG 14.....\$	547.00
				SG 16.....\$	565.00
				SG 18.....\$	582.00
				SG 20.....\$	600.00
				SG 22.....\$	618.00
				SG 24.....\$	636.00
				SG 26.....\$	654.00
				SG 28.....\$	672.00
				SG 30.....\$	690.00
				COM.....\$	457.00

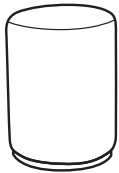

Jung Bench OC013-21	44.5	18	19.5	SG 04.....\$	1107.00
				SG 05.....\$	1115.00
				SG 06.....\$	1123.00
				SG 08.....\$	1139.00
				SG 10.....\$	1155.00
				SG 12.....\$	1171.00
				SG 14.....\$	1187.00
				SG 16.....\$	1203.00
				SG 18.....\$	1219.00
				SG 20.....\$	1235.00
				SG 22.....\$	1250.00
				SG 24.....\$	1266.00
				SG 26.....\$	1282.00
				SG 28.....\$	1298.00
				SG 30.....\$	1314.00
				COM.....\$	1107.00

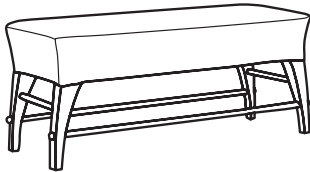

Maas Ottoman O2570-08	30.75	22.5	19.5	SG 04.....\$	576.00
				SG 05.....\$	587.00
				SG 06.....\$	599.00
				SG 08.....\$	621.00
				SG 10.....\$	644.00
				SG 12.....\$	667.00
				SG 14.....\$	690.00
				SG 16.....\$	713.00
				SG 18.....\$	736.00
				SG 20.....\$	759.00
				SG 22.....\$	782.00
				SG 24.....\$	805.00
				SG 26.....\$	828.00
				SG 28.....\$	850.00
				SG 30.....\$	873.00
				COM.....\$	576.00

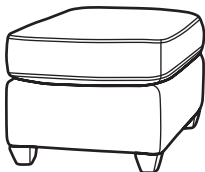

Item Description	W"	D"	H"	Fabric Grade	List Price
Elion Ottoman OC030-08S	16	16	16	SG 04.....\$	457.00
				SG 05.....\$	466.00
				SG 06.....\$	475.00
				SG 08.....\$	493.00
				SG 10.....\$	511.00
				SG 12.....\$	529.00
				SG 14.....\$	547.00
				SG 16.....\$	565.00
				SG 18.....\$	582.00
				SG 20.....\$	600.00
				SG 22.....\$	618.00
				SG 24.....\$	636.00
				SG 26.....\$	654.00
				SG 28.....\$	672.00
				SG 30.....\$	690.00
				COM.....\$	457.00

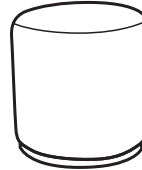

Graves Ottoman O2088-08	28	19	16.25	SG 04.....\$	547.00
				SG 05.....\$	556.00
				SG 06.....\$	564.00
				SG 08.....\$	581.00
				SG 10.....\$	598.00
				SG 12.....\$	615.00
				SG 14.....\$	632.00
				SG 16.....\$	649.00
				SG 18.....\$	666.00
				SG 20.....\$	683.00
				SG 22.....\$	700.00
				SG 24.....\$	717.00
				SG 26.....\$	734.00
				SG 28.....\$	751.00
				SG 30.....\$	768.00
				COM.....\$	547.00

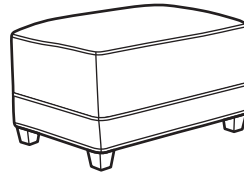

Kahn Ottoman O2083-08	24.75	20	17.5	SG 04.....\$	461.00
				SG 05.....\$	470.00
				SG 06.....\$	479.00
				SG 08.....\$	498.00
				SG 10.....\$	517.00
				SG 12.....\$	536.00
				SG 14.....\$	555.00
				SG 16.....\$	574.00
				SG 18.....\$	593.00
				SG 20.....\$	612.00
				SG 22.....\$	631.00
				SG 24.....\$	650.00
				SG 26.....\$	669.00
				SG 28.....\$	688.00
				SG 30.....\$	706.00
				COM.....\$	461.00

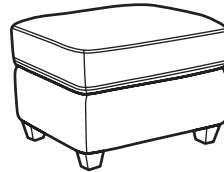

Perry Ottoman OC035-08A	36.25	36.25	19	SG 04.....\$	2146.00
				SG 05.....\$	2160.00
				SG 06.....\$	2175.00
				SG 08.....\$	2203.00
				SG 10.....\$	2232.00
				SG 12.....\$	2261.00
				SG 14.....\$	2290.00
				SG 16.....\$	2319.00
				SG 18.....\$	2348.00
				SG 20.....\$	2377.00
				SG 22.....\$	2406.00
				SG 24.....\$	2434.00
				SG 26.....\$	2463.00
				SG 28.....\$	2492.00
				SG 30.....\$	2521.00
				COM.....\$	2146.00

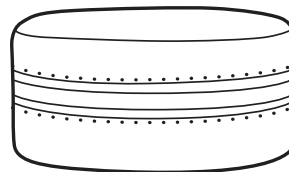

Seating Solutions



FLEXSTEEL®
CONTRACT

Made-to-Order Ottomans & Benches

Item Description

Model Number	W"	D"	H"	Fabric Grade	List Price
Tull Ottoman				SG 04.....	\$ 512.00
OC029-08	19	19	12.5	SG 05.....	\$ 524.00
				SG 06.....	\$ 537.00
				SG 08.....	\$ 562.00
				SG 10.....	\$ 587.00
				SG 12.....	\$ 612.00
				SG 14.....	\$ 636.00
				SG 16.....	\$ 661.00
				SG 18.....	\$ 686.00
				SG 20.....	\$ 711.00
				SG 22.....	\$ 736.00
				SG 24.....	\$ 761.00
				SG 26.....	\$ 786.00
				SG 28.....	\$ 811.00
				SG 30.....	\$ 836.00
				COM.....	\$ 512.00

• COM yardage: 2.5

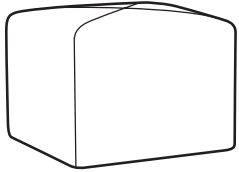

Walker Ottoman				SG 04.....	\$ 723.00
OC026-08	48	28	18	SG 05.....	\$ 739.00
				SG 06.....	\$ 755.00
				SG 08.....	\$ 787.00
				SG 10.....	\$ 819.00
				SG 12.....	\$ 851.00
				SG 14.....	\$ 883.00
				SG 16.....	\$ 914.00
				SG 18.....	\$ 946.00
				SG 20.....	\$ 978.00
				SG 22.....	\$ 1010.00
				SG 24.....	\$ 1042.00
				SG 26.....	\$ 1074.00
				SG 28.....	\$ 1106.00
				SG 30.....	\$ 1137.00
				COM.....	\$ 723.00

• COM yardage: 3.2

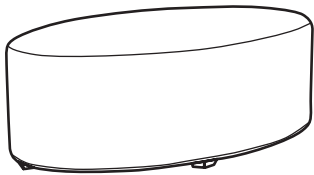

Item Description

Model Number	W"	D"	H"	Fabric Grade	List Price
Vicker Ottoman				SG 04.....	\$ 476.00
OC039-08	18	18	19	SG 05.....	\$ 483.00
				SG 06.....	\$ 490.00
				SG 08.....	\$ 504.00
				SG 10.....	\$ 518.00
				SG 12.....	\$ 532.00
				SG 14.....	\$ 546.00
				SG 16.....	\$ 560.00
				SG 18.....	\$ 574.00
				SG 20.....	\$ 588.00
				SG 22.....	\$ 602.00
				SG 24.....	\$ 615.00
				SG 26.....	\$ 629.00
				SG 28.....	\$ 643.00
				SG 30.....	\$ 657.00
				COM.....	\$ 476.00

• COM yardage: 1.4
• Legs available in brushed nickel only

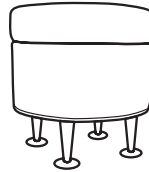

Walker Ottoman				SG 04.....	\$ 884.00
OC026-08NC	48	28	18	SG 05.....	\$ 900.00
				SG 06.....	\$ 916.00
				SG 08.....	\$ 948.00
				SG 10.....	\$ 980.00
				SG 12.....	\$ 1012.00
				SG 14.....	\$ 1044.00
				SG 16.....	\$ 1075.00
				SG 18.....	\$ 1107.00
				SG 20.....	\$ 1139.00
				SG 22.....	\$ 1171.00
				SG 24.....	\$ 1203.00
				SG 26.....	\$ 1235.00
				SG 28.....	\$ 1267.00
				SG 30.....	\$ 1298.00
				COM.....	\$ 884.00

• COM yardage: 3.2
• Nailhead trim standard

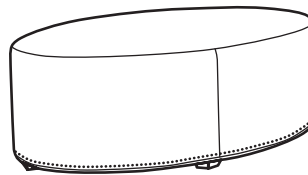



Seating Solutions

Made-to-Order Recliners

Item Description	W"	D"	H"	Fabric Grade	List Price
Firefighter Recliner F217R-500	37	38-66	42	SG 04.....\$	1616.00
				SG 06.....\$	1669.00
				SG 08.....\$	1721.00
				SG 10.....\$	1774.00
				SG 12.....\$	1827.00
				SG 14.....\$	1880.00
				SG 16.....\$	1932.00
				SG 18.....\$	1985.00
				SG 20.....\$	2038.00
				SG 22.....\$	2091.00
				SG 26.....\$	2196.00
				COM.....\$	1616.00



• Seat height: 20"					
• Seat width: 20"					
• Seat depth: 21"					
• Arm height: 24"					
• COM yardage: 6.5					

Item Description	W"	D"	H"	Fabric Grade	List Price
Firefighter Recliner F238R-500	37	37-63.5	40	SG 04.....\$	1725.00
				SG 06.....\$	1781.00
				SG 08.....\$	1837.00
				SG 10.....\$	1893.00
				SG 12.....\$	1948.00
				SG 14.....\$	2004.00
				SG 16.....\$	2060.00
				SG 18.....\$	2116.00
				SG 20.....\$	2171.00
				SG 22.....\$	2227.00
				SG 26.....\$	2339.00
				COM.....\$	1725.00

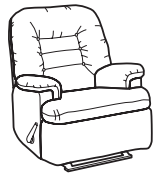

• Seat height: 18"					
• Seat width: 20"					
• Seat depth: 21"					
• Arm height: 23"					
• COM yardage: 7.0					

Item Description	W"	D"	H"	Fabric Grade	List Price
Firefighter Recliner F289R-501	41	44-73	47	SG 04.....\$	1976.00
				SG 06.....\$	2048.00
				SG 08.....\$	2120.00
				SG 10.....\$	2192.00
				SG 12.....\$	2263.00
				SG 14.....\$	2335.00
				SG 16.....\$	2407.00
				SG 18.....\$	2478.00
				SG 20.....\$	2550.00
				SG 22.....\$	2622.00
				SG 26.....\$	2765.00
				COM.....\$	1976.00



Item Description	W"	D"	H"	Fabric Grade	List Price
Firefighter Recliner F218R-500	38	36-64	40	SG 04.....\$	1952.00
				SG 06.....\$	2026.00
				SG 08.....\$	2101.00
				SG 10.....\$	2176.00
				SG 12.....\$	2250.00
				SG 14.....\$	2325.00
				SG 16.....\$	2400.00
				SG 18.....\$	2474.00
				SG 20.....\$	2549.00
				SG 22.....\$	2624.00
				SG 26.....\$	2773.00
				COM.....\$.00



• Seat height: 20"					
• Seat width: 22"					
• Seat depth: 20"					
• Arm height: 25"					
• COM yardage: 8.5					

Item Description	W"	D"	H"	Fabric Grade	List Price
Firefighter Recliner F277R-500	29.5	35-64.5	41	SG 04.....\$	1466.00
				SG 06.....\$	1513.00
				SG 08.....\$	1560.00
				SG 10.....\$	1607.00
				SG 12.....\$	1653.00
				SG 14.....\$	1700.00
				SG 16.....\$	1747.00
				SG 18.....\$	1794.00
				SG 20.....\$	1841.00
				SG 22.....\$	1887.00
				SG 26.....\$	1981.00
				COM.....\$	1466.00



• Seat height: 18.5"					
• Seat width: 22"					
• Seat depth: 20"					
• Arm height: 21.5"					
• COM yardage: 6.0					

Item Description	W"	D"	H"	Fabric Grade	List Price
Firefighter Recliner F482R-500	40	39-67	41	SG 04.....\$	2029.00
				SG 06.....\$	2097.00
				SG 08.....\$	2165.00
				SG 10.....\$	2232.00
				SG 12.....\$	2300.00
				SG 14.....\$	2368.00
				SG 16.....\$	2435.00
				SG 18.....\$	2503.00
				SG 20.....\$	2571.00
				SG 22.....\$	2639.00
				SG 26.....\$	2774.00
				COM.....\$	2029.00



Seating Solutions



FLEXSTEEL®
CONTRACT

Made-to-Order Zoll Collection

Item Description

Model Number	W"	D"	H"	Fabric Grade	List Price
Zoll Single Armless Chair					
OC054-1924	24.25	24.25	29.75	SG 04.....	\$ 737.00
				SG 05.....	\$ 748.00
				SG 06.....	\$ 759.00
				SG 08.....	\$ 781.00
				SG 10.....	\$ 803.00
				SG 12.....	\$ 825.00
				SG 14.....	\$ 847.00
				SG 16.....	\$ 869.00
				SG 18.....	\$ 891.00
				SG 20.....	\$ 913.00
				SG 22.....	\$ 935.00
				SG 24.....	\$ 956.00
				SG 26.....	\$ 978.00
				SG 28.....	\$ 1000.00
				SG 30.....	\$ 1022.00
				COM.....	\$ 737.00

- Seat height: 18"
- Seat width: 25"
- Seat depth: 18"
- COM yardage: 2.2
- Metal legs require installation

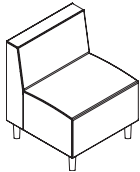

Zoll Single Ottoman

Model Number	W"	D"	H"	Fabric Grade	List Price
OC054-0824	24	24	18	SG 04.....	\$ 526.00
				SG 05.....	\$ 533.00
				SG 06.....	\$ 541.00
				SG 08.....	\$ 556.00
				SG 10.....	\$ 571.00
				SG 12.....	\$ 586.00
				SG 14.....	\$ 601.00
				SG 16.....	\$ 616.00
				SG 18.....	\$ 630.00
				SG 20.....	\$ 645.00
				SG 22.....	\$ 660.00
				SG 24.....	\$ 675.00
				SG 26.....	\$ 690.00
				SG 28.....	\$ 705.00
				SG 30.....	\$ 720.00
				COM.....	\$ 526.00

- COM yardage: 1.5
- Metal legs require installation

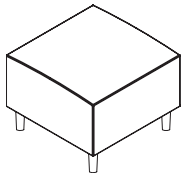

Item Description

Model Number	W"	D"	H"	Fabric Grade	List Price
Zoll Double Armless Chair					
OC054-1936	36.25	24.25	29.75	SG 04.....	\$ 830.00
				SG 05.....	\$ 844.00
				SG 06.....	\$ 857.00
				SG 08.....	\$ 884.00
				SG 10.....	\$ 911.00
				SG 12.....	\$ 938.00
				SG 14.....	\$ 965.00
				SG 16.....	\$ 992.00
				SG 18.....	\$ 1018.00
				SG 20.....	\$ 1045.00
				SG 22.....	\$ 1072.00
				SG 24.....	\$ 1099.00
				SG 26.....	\$ 1126.00
				SG 28.....	\$ 1153.00
				SG 30.....	\$ 1180.00
				COM.....	\$ 830.00

- Seat height: 18"
- Seat width: 25"
- Seat depth: 18"
- COM yardage: 2.7
- Metal legs require installation

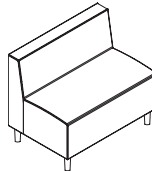

Zoll Double Ottoman

Model Number	W"	D"	H"	Fabric Grade	List Price
OC054-0836	36.25	24	18	SG 04.....	\$ 595.00
				SG 05.....	\$ 604.00
				SG 06.....	\$ 613.00
				SG 08.....	\$ 631.00
				SG 10.....	\$ 649.00
				SG 12.....	\$ 667.00
				SG 14.....	\$ 685.00
				SG 16.....	\$ 703.00
				SG 18.....	\$ 721.00
				SG 20.....	\$ 738.00
				SG 22.....	\$ 756.00
				SG 24.....	\$ 774.00
				SG 26.....	\$ 792.00
				SG 28.....	\$ 810.00
				SG 30.....	\$ 828.00
				COM.....	\$ 595.00

- COM yardage: 1.8
- Metal legs require installation

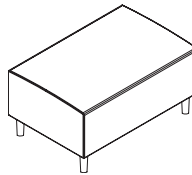











Seating Solutions

DMI COLLECTION

In-Stock Executive, Management, & Task Chairs

Item Description	W"	D"	H"	Weight	Cubic	List	Features
Model Number				Lbs.	Ft.	Price	
 Belmont Executive Leather High Back Chair 713_-80	26.5	28.5	45-48	71	17.4	\$ 1285.00	<ul style="list-style-type: none"> • 7130 Executive Cherry finish • 7132 Brown Cherry finish • Upholstered in black leather • Five star base • Knee tilt mechanism • 18" seat depth • Seat height adjusts from 20"-23"
 Belmont Executive Leather Med Back Chair 713_-81	26.5	28.5	38.5-42.5	63	12.5	\$ 1168.00	<ul style="list-style-type: none"> • 7130 Executive Cherry finish • 7132 Brown Cherry finish • Upholstered in black leather • Five star base • Knee tilt mechanism • 18" seat depth • Seat height adjusts from 20"-23"
 Hadley Roll Arm Executive Desk Chair in Black Leather 6940-1101 6940-1105 6940-1106	27 27 27	29.75 29.75 29.75	43-46.5 43-46.5 43-46.5	64 64 64	16.2 16.2 16.2	\$ 700.00 \$ 700.00 \$ 700.00	<ul style="list-style-type: none"> • -1101 Executive Mahogany frame (7350) • -1105 English Cherry frame (7990) • -1106 Bordeaux Cherry frame (7688) • Gas lift; swivel tilt mechanism; five star hooded caster base • Seat width: 23"; seat depth: 19.5"; seat height: 19"-22.5
 Lotus High Back Desk Chair 6060-80	26	28	45.5-48	65	15	\$ 675.00	<ul style="list-style-type: none"> • Chrome frame with black synthetic leather cover • Swivel-tilt mechanism • Gas lift • Seat width: 19.75"; seat depth: 19.5"; seat height: 18.5-22.5"
 Lotus Mid Back Desk Chair 6060-81	25	26	41-43.5	51	13.3	\$ 625.00	<ul style="list-style-type: none"> • Chrome frame with black synthetic leather cover • Swivel-tilt mechanism • Gas lift • Seat width: 19.75"; seat depth: 19.5"; seat height: 18-22.5"
 Pantera Metal High Back Desk Chair 6041-80B 6041-80T 6041-80W	22.5 22.5 22.5	26 26 26	43-46 43-46 43-46	50 50 50	10.6 10.6 10.6	\$ 524.00 \$ 524.00 \$ 524.00	<ul style="list-style-type: none"> • Chrome frame with black (B), tan (T) or white (W) synthetic leather cover • Pneumatic knee-tilt • Swivel-tilt • Front lock-out • Seat width: 18.5"; seat depth: 17.5"; seat height: 19-22"
 Pantera Metal Low Back Desk Chair 6041-81B 6041-81T 6041-81W	22.5 22.5 22.5	24.5 24.5 24.5	36-39 36-39 36-39	18 18 18	9.4 9.4 9.4	\$ 512.00 \$ 512.00 \$ 512.00	<ul style="list-style-type: none"> • Chrome frame with black (B), tan (T) or white (W) synthetic leather cover • Pneumatic knee-tilt • Swivel-tilt • Front lock-out • Seat width: 18.5"; seat depth: 17.5"; seat height: 19-22"
 Pantera Plus Task Chair 6301-80B 6301-80W	24.75-27.5 24.75-27.5	23.5 23.5	43-47 43-47	65 65	15.5 15.5	\$ 765.00 \$ 765.00	<ul style="list-style-type: none"> • Chrome frame with black (B) or white (W) synthetic leather cover • Pneumatic knee-tilt • Swivel • Front lock-out • Adjustable arm width • Seat width: 19.5"; seat depth: 20"; seat height: 22-27.75"
 Rue De Lyon Task Chair 7684-861	24.5	22.5	41.5-45.5	76	19.2	\$ 1038.00	<ul style="list-style-type: none"> • 7684 Ruby Cabernet finished frame • Black leather upholstery • Gas lift • Swivel tilt mechanism • Five star hooded caster base • Seat width: 19.25"; seat depth: 21"; seat height: 19.5-22.75"



Seating Solutions



FLEXSTEEL®
CONTRACT

In-Stock Executive, Management, & Task Chairs

DMI COLLECTION







Item Description Model Number	W"	D"	H"	Weight Lbs.	Cubic Ft.	List Price	List Price	Features
	Swan Executive High Back Chair with Upholstered Arms							<ul style="list-style-type: none"> • 7302 Sedona Cherry finished frame • 7480 West Indies Cherry finished frame • 7684 Ruby Cabernet finished frame • Black leather upholstery • Gas lift; swivel tilt mechanism • Five star hooded caster base • Seat width: 20.5"; seat depth: 19.5"; seat height: 20.5-23.5"
	7302-835	28.75	29.75	41.5-44.5	74	17.4	\$ 1089.00	
	7480-835	28.75	29.75	41.5-44.5	74	17.4	\$ 1089.00	
	7684-835	28.75	29.75	41.5-44.5	74	17.4	\$ 1089.00	
	Swan Executive High Back Chair with Wood/Upholstered Arms							<ul style="list-style-type: none"> • 7302 Sedona Cherry finished frame • 7480 West Indies Cherry finished frame • 7684 Ruby Cabernet finished frame • Black leather upholstery • Gas lift; swivel tilt mechanism • Five star hooded caster base • Seat width: 19.25"; seat depth: 20"; seat height: 20-24"
	7302-836	28.75	29.75	40.5-43.75	74	17.4	\$ 1089.00	
	7480-836	28.75	29.75	40.5-43.75	74	17.4	\$ 1089.00	
	7684-836	28.75	29.75	40.5-43.75	74	17.4	\$ 1089.00	
	Whittle Gooseneck Arm Desk Chair							<ul style="list-style-type: none"> • 6000 frame matches the 7207, 7859 Cocoa Cherry finish • 7684 Ruby Cabernet finished frame • Black leather upholstery • Gas lift; swivel tilt mechanism • Five star hooded caster base • Seat width: 24.5"; seat depth: 21.5"; seat height: 20-24"
	6000-841	24.5	24	41.5-45.5	70	18.7	\$ 1109.00	
	7684-841	24.5	24	41.5-45.5	70	18.7	\$ 1109.00	



Seating Solutions

DMI COLLECTION

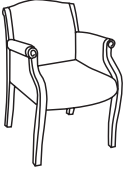
In-Stock Guest Chairs

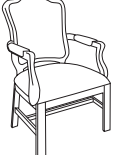
Item Description Model Number	W"	D"	H"	Weight Lbs.	Cubic Ft.	List Price	List Price	Features	
	Bently Guest Chair								
	6133-2003	24.75	24.5	35.5	29	14.8	\$	555.00	<ul style="list-style-type: none"> -2003 Cherry frame coordinates with 7041HM, 7130 -2004 Cherry frame -2012 Mocha frame coordinates with 7004, 7020, 7040MC -2014 Mahogany frame coordinates with 7006, 7042MH Seat width: 20"; seat depth: 19.5"; seat height: 17"
	6133-2004	24.75	24.5	35.5	29	14.8	\$	555.00	
	6133-2012	24.75	24.5	35.5	29	14.8	\$	555.00	
6133-2014	24.75	24.5	35.5	29	14.8	\$	555.00		
	Bently Guest Chair								
	6501-2002	24	25.5	35.5	28	14.8	\$	558.00	<ul style="list-style-type: none"> -2002 Cherry frame coordinates with 7132 -2003 Cherry frame coordinates with 7041HM, 7130 -2004 Cherry frame -2012 Mocha frame coordinates with 7004, 7020, 7040MC Seat width: 20"; seat depth: 19.25"; seat height: 17"
	6501-2003	24	25.5	35.5	28	14.8	\$	558.00	
	6501-2004	24	25.5	35.5	28	14.8	\$	558.00	
6501-2012	24	25.5	35.5	28	14.8	\$	558.00		
	Bently Guest Chair								
	6510-2003FP	21.5	24	37	27	8.1	\$	320.00	<ul style="list-style-type: none"> -2003 Cherry frame coordinates with 7041HM, 7130 -2004 Cherry frame -2012 Mocha frame coordinates with 7004, 7020, 7040MC -2013 Cognac frame coordinates with 7005 -2014 Mahogany frame coordinates with 7006, 7042MH Chair requires assembly Seat width: 19"; seat depth: 18.5"; seat height: 20.25"
	6510-2004FP	21.5	24	37	27	8.1	\$	320.00	
	6510-2012FP	21.5	24	37	27	8.1	\$	320.00	
	6510-2013FP	21.5	24	37	27	8.1	\$	320.00	
6510-2014FP	21.5	24	37	27	8.1	\$	320.00		
	Bently Guest Chair								
	6520-2002	24	24	35.5	30	14.4	\$	439.00	<ul style="list-style-type: none"> -2002 Cherry frame coordinates with 7132 -2003 Cherry frame coordinates with 7041HM, 7130 -2004 Cherry frame -2012 Mocha frame coordinates with 7004, 7020, 7040MC Seat width: 20"; seat depth: 19.25"; seat height: 17"
	6520-2003	24	24	35.5	30	14.4	\$	439.00	
	6520-2004	24	24	35.5	30	14.4	\$	439.00	
6520-2012	24	24	35.5	30	14.4	\$	439.00		
	Faraday Traditional Guest Chair								
	6855-2201	25	26	34	50	15.0	\$	688.00	<ul style="list-style-type: none"> -1101 Executive Mahogany frame (7350) -1105 English Cherry frame (7990) -1106 Bordeaux Cherry frame (7688) Burgundy fabric cover Seat width: 18.5"; seat depth: 17"; seat height: 17.75"
	6855-2205	25	26	34	50	15.0	\$	688.00	
	6855-2206	25	26	34	50	15.0	\$	688.00	
	Lotus Guest Chair								
6060-82	25	26	39.5	48	12.4	\$	499.00	<ul style="list-style-type: none"> Chrome frame with black synthetic leather cover Seat width: 19.5"; seat depth: 19.5"; seat height: 23.5" 	
	Pantera Metal & Leather Guest Chair								
	6041-82B	20.5	24.25	36	40	5.6	\$	497.00	<ul style="list-style-type: none"> Chrome frame with black (B), tan (T) or white (W) synthetic leather cover Assembly required Seat width: 18.5"; seat depth: 17.5"; seat height: 18"
	6041-82T	20.5	24.25	36	40	5.6	\$	497.00	
6041-82W	20.5	24.25	36	40	5.6	\$	497.00		
	Rue De Lyon Guest Chair								
7684-871	24.5	22.5	43.5	49	17.2	\$	981.00	<ul style="list-style-type: none"> 7684 Ruby Cabernet finished frame Black leather upholstery Seat width: 19.25"; seat depth: 21.25"; seat height: 23" 	



Seating Solutions



FLEXSTEEL®
CONTRACT

In-Stock Guest Chairs

DMI COLLECTION

	Item Description			Weight Lbs.	Cubic Ft.	List Price	List Price	Features
	Model Number	W"	D"					
	Swan High Back Guest Chair							
	7302-821	27.5	28	41	55	21.6	\$ 1015.00	• 7302 Sedona Cherry finished frame
	7480-821	27.5	28	41	55	21.6	\$ 1015.00	• 7480 West Indies Cherry finished frame
	7684-821	27.5	28	41	55	21.6	\$ 1015.00	• 7684 Ruby Cabernet finished frame • Black leather upholstery • Seat width: 17-19.5"; seat depth: 18"; seat height: 19"
	Whittle Gooseneck Guest Chair							
	6000-851	24.5	24	43.5	49	23.2	\$ 1003.00	• 7207, 7859 Cocoa Cherry finished frame
	7684-851	24.5	24	43.5	49	23.2	\$ 1003.00	• 7684 Ruby Cabernet finished frame • Black leather upholstery • Seat width: 21.75"; seat depth: 20"; seat height: 19"



Seating Solutions

DMI COLLECTION

In-Stock Collections

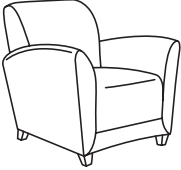
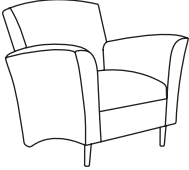
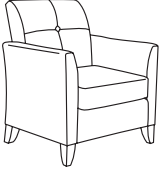
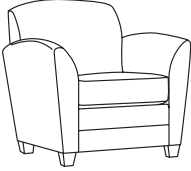
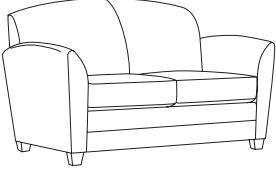
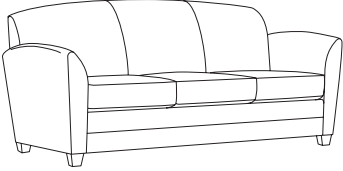
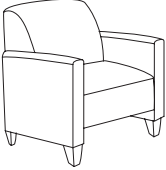
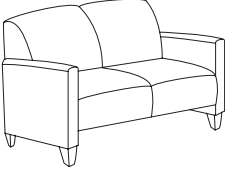
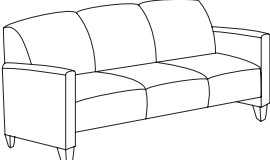
Item Description Model Number	W"	D"	H"	Weight Lbs.	Cubic Ft.	List Price	Features	
	Charisma Chair*							
	OC2008-10-4-B4980*	32	35	34	80	25.4	\$ 1355.00	<ul style="list-style-type: none"> • Stocked with Mocha legs only • D1621-Tea Time Olive (Grade 4) • B4980-Winslow Cashew (Grade 4) • Seat width: 20"; seat depth: 22.25"; seat height: 18.25"; arm height: 25.75"
OC2008-10-4-D1621*	32	35	34	80	25.4	\$ 1355.00		
	Charisma Chair*							
	OC2416-10-HD-B4980*	34.5	33	34.5	85	32.5	\$ 1387.00	<ul style="list-style-type: none"> • Stocked with metal legs only • D1621-Tea Time Olive (Grade 4) • B4980-Winslow Cashew (Grade 4) • Seat width: 20.5"; seat depth: 20.5"; seat height: 18"; arm height: 26.5"
OC2416-10-HD-D1621*	34.5	33	34.5	85	32.5	\$ 1387.00		
	Charisma Chair*							
	OC2735-10-4-B4980*	30	29	36.5	68	32.5	\$ 1586.00	<ul style="list-style-type: none"> • Stocked with Mocha legs only • D1621-Tea Time Olive (Grade 4) • B4980-Winslow Cashew (Grade 4) • Seat width: 20"; seat depth: 22.25"; seat height: 18.25"; arm height: 25.75"
OC2735-10-4-D1621*	30	29	36.5	68	32.5	\$ 1586.00		
	LeMans Chair*							
	CH100-10-5-B5000*	32	35.5	35	89	29.1	\$ 1164.00	<ul style="list-style-type: none"> • Stocked with black legs only • 5000-Black (Grade 4) • 5070-Java/Brown (Grade 4) • 5080-Buff (Grade 4) • Seat width: 20"; seat depth: 21"; seat height: 18.5"; arm height: 26.25"
	CH100-10-5-B5070*	32	35.5	35	89	29.1	\$ 1164.00	
	CH100-10-5-B5080*	32	35.5	35	89	29.1	\$ 1164.00	
	LeMans Loveseat*							
	CH100-20-5-B5000*	58.5	35.5	35	127	53.6	\$ 1998.00	<ul style="list-style-type: none"> • Stocked with black legs only • 5000-Black (Grade 4) • 5070-Java/Brown (Grade 4) • 5080-Buff (Grade 4) • Seat width: 46.5"; seat depth: 21"; seat height: 18.5"; arm height: 26.25"
	CH100-20-5-B5070*	58.5	35.5	35	127	53.6	\$ 1998.00	
	CH100-20-5-B5080*	58.5	35.5	35	127	53.6	\$ 1998.00	
	LeMans Sofa*							
	CH100-31-5-B5000*	78.5	35.5	35	150	71.0	\$ 2415.00	<ul style="list-style-type: none"> • Stocked with black legs only • 5000-Black (Grade 4) • 5070-Java/Brown (Grade 4) • 5080-Buff (Grade 4) • Seat width: 66.5"; seat depth: 21"; seat height: 18.5"; arm height: 26.25"
	CH100-31-5-B5070*	78.5	35.5	35	150	71.0	\$ 2415.00	
	CH100-31-5-B5080*	78.5	35.5	35	150	71.0	\$ 2415.00	
	Monaco Chair*							
	CD001-10-5-B5000*	33	32	34	41	24.8	\$ 1662.00	<ul style="list-style-type: none"> • Stocked with black legs only • 5000-Black (Grade 4) • 5070-Java/Brown (Grade 4) • 5080-Buff (Grade 4) • Seat width: 25"; seat depth: 20"; seat height: 19"; arm height: 25"
	CD001-10-5-B5070*	33	32	34	41	24.8	\$ 1662.00	
	CD001-10-5-B5080*	33	32	34	41	24.8	\$ 1662.00	
	Monaco Loveseat*							
	CD001-20-5-B5000*	52	32	34	59	38.8	\$ 1988.00	<ul style="list-style-type: none"> • Stocked with black legs only • 5000-Black (Grade 4) • 5070-Java/Brown (Grade 4) • 5080-Buff (Grade 4) • Seat width: 43"; seat depth: 20"; seat height: 19"; arm height: 25"
	CD001-20-5-B5070*	52	32	34	59	38.8	\$ 1988.00	
	CD001-20-5-B5080*	52	32	34	59	38.8	\$ 1988.00	
	Monaco Sofa*							
	CD001-30-5-B5000*	73	32	34	76	53.1	\$ 2365.00	<ul style="list-style-type: none"> • Stocked with black legs only • 5000-Black (Grade 4) • 5070-Java/Brown (Grade 4) • 5080-Buff (Grade 4) • Seat width: 64"; seat depth: 20"; seat height: 19"; arm height: 25"
	CD001-30-5-B5070*	73	32	34	76	53.1	\$ 2365.00	
	CD001-30-5-B5080*	73	32	34	76	53.1	\$ 2365.00	

* Items within this collection marked with an asterisk are GSA items.

Seating Solutions



FLEXSTEEL®
CONTRACT

In-Stock Collections

DMI COLLECTION

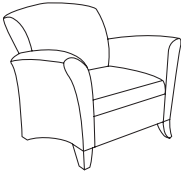
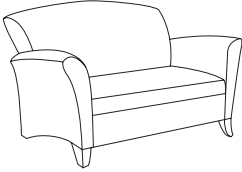
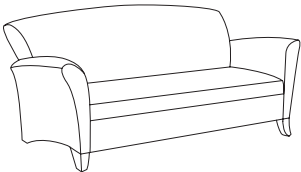
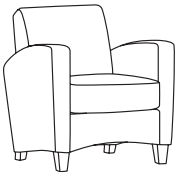
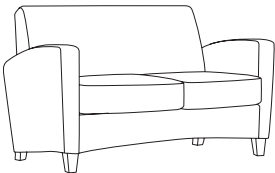
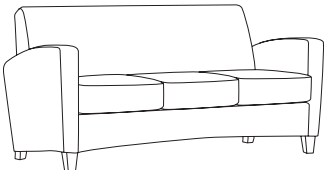
Item Description Model Number	W"	D"	H"	Weight Lbs.	Cubic Ft.	List		
						Price	Features	
 Monza Chair* DA011-10-5-B5000* DA011-10-5-B5070* DA011-10-5-B5080*	34.75	33	35.5	55	28.7	\$	1562.00	<ul style="list-style-type: none"> • Stocked with black legs only • 5000-Black (Grade 4) • 5070-Java/Brown (Grade 4) • 5080-Buff (Grade 4) • Seat width: 20"; seat depth: 20.5"; seat height: 19"; arm height: 26.5"
	34.75	33	35.5	55	28.7	\$	1562.00	
	34.75	33	35.5	55	28.7	\$	1562.00	
	34.75	33	35.5	55	28.7	\$	1562.00	
 Monza Loveseat* DA011-20-5-B5000* DA011-20-5-B5070* DA011-20-5-B5080*	54	33.5	35.5	80	46.5	\$	1992.00	<ul style="list-style-type: none"> • Stocked with black legs only • 5000-Black (Grade 4) • 5070-Java/Brown (Grade 4) • 5080-Buff (Grade 4) • Seat width: 39.5"; seat depth: 20.5"; seat height: 19.5"; arm height: 26.5"
	54	33.5	35.5	80	46.5	\$	1992.00	
	54	33.5	35.5	80	46.5	\$	1992.00	
	54	33.5	35.5	80	46.5	\$	1992.00	
 Monza Sofa* DA011-31-5-B5000* DA011-31-5-B5070* DA011-31-5-B5080*	82	33.5	35.5	116	60.7	\$	2432.00	<ul style="list-style-type: none"> • Stocked with black legs only • 5000-Black (Grade 4) • 5070-Java/Brown (Grade 4) • 5080-Buff (Grade 4) • Seat width: 67.25"; seat depth: 20.5"; seat height: 19.5"; arm height: 26.5"
	82	33.5	35.5	116	60.7	\$	2432.00	
	82	33.5	35.5	116	60.7	\$	2432.00	
	82	33.5	35.5	116	60.7	\$	2432.00	
 Sebring Chair* CH108-10-5-B-5000* CH108-10-5-B-5070* CH108-10-5-B-5080*	30	32	34	73	24.8	\$	1378.00	<ul style="list-style-type: none"> • Stocked with black legs only • 5000-Black (Grade 4) • 5070-Java/Brown (Grade 4) • 5080-Buff (Grade 4) • Seat width: 20"; seat depth: 20.5"; seat height: 19"; arm height: 26.5"
	30	32	34	73	24.8	\$	1378.00	
	30	32	34	73	24.8	\$	1378.00	
	30	32	34	73	24.8	\$	1378.00	
 Sebring Loveseat* CH108-20-5-B-5000* CH108-20-5-B-5070* CH108-20-5-B-5080*	50	32	34	112	41.9	\$	1806.00	<ul style="list-style-type: none"> • Stocked with black legs only • 5000-Black (Grade 4) • 5070-Java/Brown (Grade 4) • 5080-Buff (Grade 4) • Seat width: 40"; seat depth: 20.5"; seat height: 19"; arm height: 26.5"
	50	32	34	112	41.9	\$	1806.00	
	50	32	34	112	41.9	\$	1806.00	
	50	32	34	112	41.9	\$	1806.00	
 Sebring Sofa* CH108-30-5-B-5000* CH108-30-5-B-5070* CH108-30-5-B-5080*	70.5	32	34	140	56.8	\$	2253.00	<ul style="list-style-type: none"> • Stocked with black legs only • 5000-Black (Grade 4) • 5070-Java/Brown (Grade 4) • 5080-Buff (Grade 4) • Seat width: 60.5"; seat depth: 20.5"; seat height: 19"; arm height: 26.5"
	70.5	32	34	140	56.8	\$	2253.00	
	70.5	32	34	140	56.8	\$	2253.00	
	70.5	32	34	140	56.8	\$	2253.00	

* Items within this collection marked with an asterisk are GSA items.



Seating Solutions

In-Stock Zoll Collections

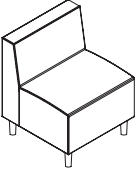
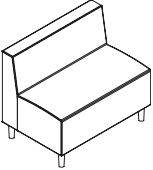
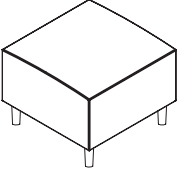
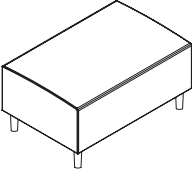
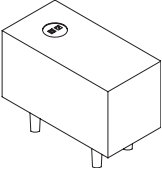
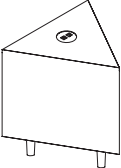

Item Description Model Number	W"	D"	H"	Weight Lbs.	Cubic Ft.	List Price	Features
 Single Armless Chair OC054-1924-A5922 OC054-1924-A5930 OC054-1924-A6010 OC054-1924-A6160	24.25	24.5	29.75	50	14.5	\$ 999.00	<ul style="list-style-type: none"> • Stocked fabrics A5922 (green fabric), A5930 (blue fabric), A6010 (white vinyl), and A6160 (deep orange vinyl) • Seat height: 18" • Seat width: 25" • Seat depth: 18" • Metal legs require installation
						\$ 999.00	
						\$ 1023.00	
						\$ 1023.00	
 Double Armless Chair OC054-1936-A5922 OC054-1936-A5930 OC054-1936-A6010 OC054-1936-A6160	36.25	24.5	29.75	65	18.3	\$ 1167.00	<ul style="list-style-type: none"> • Stocked fabrics A5922 (green fabric), A5930 (blue fabric), A6010 (white vinyl), and A6160 (deep orange vinyl) • Seat height: 18" • Seat width: 36.25" • Seat depth: 18" • Metal legs require installation
						\$ 1167.00	
						\$ 1197.00	
						\$ 1197.00	
 Single Ottoman OC054-0824-A5922 OC054-0824-A5930 OC054-0824-A6010 OC054-0824-A6160	24	24	18	22	8.6	\$ 722.00	<ul style="list-style-type: none"> • Stocked fabrics A5922 (green fabric), A5930 (blue fabric), A6010 (white vinyl), and A6160 (deep orange vinyl) • Metal legs require installation
						\$ 722.00	
						\$ 739.00	
						\$ 739.00	
 Double Ottoman OC054-0836-A5922 OC054-0836-A5930 OC054-0836-A6010 OC054-0836-A6160	36	24	18	30	12.6	\$ 815.00	<ul style="list-style-type: none"> • Stocked fabrics A5922 (green fabric), A5930 (blue fabric), A6010 (white vinyl), and A6160 (deep orange vinyl) • Metal legs require installation
						\$ 815.00	
						\$ 834.00	
						\$ 834.00	
 Rectangular Power Pod OC054-R1_	12	24	18		3.6	\$ 886.00	<ul style="list-style-type: none"> • Available in 7011 Smoke or 7012 Bourbon finishes • 2 USB ports; 1 outlet • Metal legs require installation
 Triangle Power Pod OC054-T1_	24	24	26		8.2	\$ 938.00	<ul style="list-style-type: none"> • Available in 7011 Smoke or 7012 Bourbon finishes • 2 USB ports; 1 outlet • Metal legs require installation

Seating Solutions



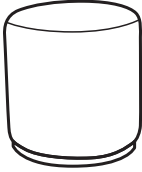
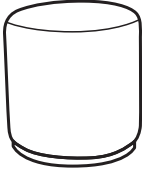

FLEXSTEEL®
CONTRACT

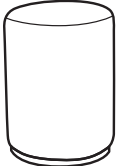
In-Stock Ottoman

	Item Description Model Number	W"	D"	H"	Weight Lbs.	Cubic Ft.	List Price	Features
	Elion Ottoman OC030-08S-A5922SM OC030-08S-A5922OV OC030-08S-A5930SM OC030-08S-A5930OV	16	16	16			\$ 511.00	<ul style="list-style-type: none"> • Stocked in select fabrics and finishes as a complement to the Zoll group • A5922 Green fabric (Grade 10) • A5930 Blue fabric (Grade 10) • SM Smoke standard finish • OV Old Vine standard finish
	Elion Ottoman OC030-08S-A6010SM OC030-08S-A6010OV OC030-08S-A6160SM OC030-08S-A6160OV	16	16	16			\$ 529.00	<ul style="list-style-type: none"> • Stocked in select vinyls and finishes as a complement to the Zoll group • A6010 White vinyl (Grade 12) • A6160 Deep Orange vinyl (Grade 12) • SM Smoke standard finish • OV Old Vine standard finish
	Elion Ottoman OC030-08T-A5922SM OC030-08T-A5922OV OC030-08T-A5930SM OC030-08T-A5930OV	16	16	21			\$ 511.00	<ul style="list-style-type: none"> • Stocked in select fabrics and finishes as a complement to the Zoll group • A5922 Green fabric (Grade 10) • A5930 Blue fabric (Grade 10) • SM Smoke standard finish • OV Old Vine standard finish
	Elion Ottoman OC030-08T-A6010SM OC030-08T-A6010OV OC030-08T-A6160SM OC030-08T-A6160OV	16	16	21			\$ 529.00	<ul style="list-style-type: none"> • Stocked in select vinyls and finishes as a complement to the Zoll group • A6010 White vinyl (Grade 12) • A6160 Deep Orange vinyl (Grade 12) • SM Smoke standard finish • OV Old Vine standard finish

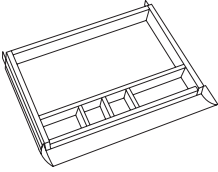
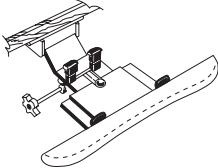
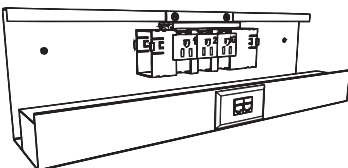

DMI COLLECTION

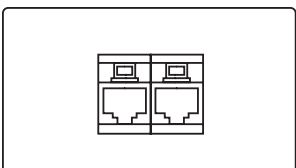
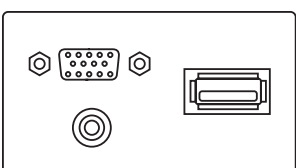
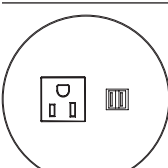
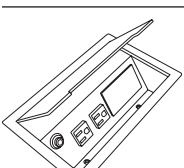
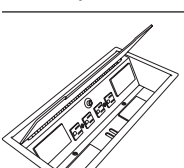
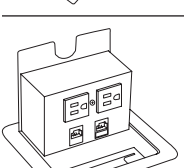

Item Description Model Number	W"	D"	H"	Weight Lbs.	Cubic Ft.	List Price	Features
 Optional Center Drawer 0000-2	20.5	18	2	6	0.7	\$ 96.00	• Black finish, compartmentalized drawer
 Deluxe Keyboard Support with Mouse Pad 0000-7	32	20		12	0.6	\$ 433.00	<ul style="list-style-type: none"> • Includes arm, clamp, palm rest and 17.75" track keyboard secures with knob operated clamp comfortable • Washable foam palm rest 5.75 of height adjustment +/- 15° of tilt adjustment • Steel constructed in a black matte finish
 19" J-Channel 0000-13	19	4	8	2	0.4	\$ 215.00	• Three electrical outlets one telecom plate cutout
 72" Starter Cable Cord for J-Channel 0000-64				1	0.1	\$ 189.00	
 Conference Table Telecom Plate 0000-22				1	0.4	\$ 132.00	<ul style="list-style-type: none"> • Two data ports RJ-45 • Fits into 0000-28, 0000-29, 0000-26, 0000-27
 Conference Table Telecom Plate 0000-23				1	0.4	\$ 315.00	<ul style="list-style-type: none"> • One each HDMI, VGA, stereo port • Fits into 0000-28, 0000-29, 0000-26, 0000-27
 Mini Cove Power Center 0000-24	4	4		1	0.4	\$ 420.00	• 0000-24 in Black
0000-25	4	4		1	0.4	\$ 420.00	• 0000-25 in Silver Powder Coat
Installation per Unit 0000-3199						\$ 497.00	<ul style="list-style-type: none"> • A power receptacle, two USB ports, and 72" cord • Fits in Keswick and Belmont EX Tables <p><i>Note: Orders for installations cannot be cancelled</i></p>
 Conference Table Power Center 0000-26				4	0.2	\$ 391.00	• 0000-26 in Black
0000-27				4	0.2	\$ 422.00	• 0000-27 in Pearl
Installation per Unit 0000-3199						\$ 497.00	<ul style="list-style-type: none"> • Table top unit with one duplex (two power outlets), 15 amp circuit breaker, third receptacle in bottom of unit for convenient outlet, cutout for one telecom plate, 72" cord; UL listed; CSA certified <p><i>Note: Orders for installations cannot be cancelled</i></p>
 Conference Table Power Center 0000-28				4	0.2	\$ 785.00	• 0000-28 in Black
0000-29				4	0.2	\$ 762.00	• 0000-29 in Pearl
Installation per Unit 0000-3199						\$ 497.00	<ul style="list-style-type: none"> • Table top unit with two duplexes (four power outlets), 15 amp circuit breaker, cutout for 4 telecom plate, 72" cord • UL listed; CSA certified <p><i>Note: Orders for installations cannot be cancelled</i></p>
 Conference Table Data / Power Center 0000-31				4	0.2	\$ 381.00	• 0000-31 in Black
0000-32				4	0.2	\$ 443.00	• 0000-32 in Silver Powder Coat
Installation per Unit 0000-3199						\$ 497.00	<ul style="list-style-type: none"> • Tabletop flip up unit with 2 power receptacles, 2 RJ-475 cat 6 connectors, 72" cord • UL listed; CSA certified <p><i>Note: Orders for installations cannot be cancelled</i></p>

Accessories



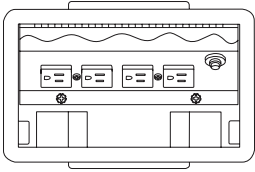
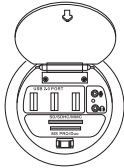
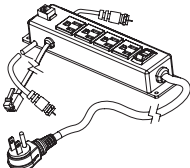
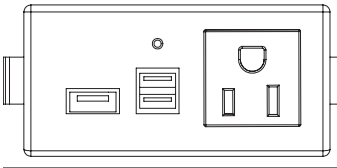
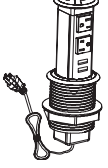
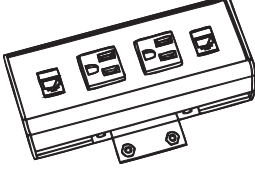
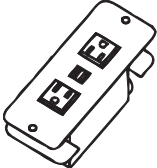
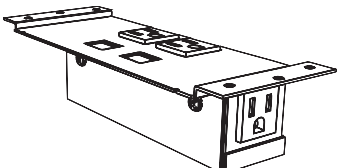

FLEXSTEEL®
CONTRACT

DMI COLLECTION

Item Description Model Number	W"	D"	H"	Weight Lbs.	Cubic Ft.	List		
						Price	Features	
 <p>Conference Table Power Center with Surge Protector 0000-35 0000-36</p>				4	0.2	\$	687.00	<ul style="list-style-type: none"> • 0000-35 in Black • 0000-36 in Pearl • Table top unit with two duplexes (four power outlets), 72" cord with molded plug, 15 amp circuit breaker • UL listed; CSA certified <p>Note: Orders for installations cannot be cancelled</p>
				4	0.2	\$	714.00	
	Installation per Unit 0000-3199						\$	
 <p>Hide-A-Dock 0000-38</p>	3.5	2.5	2.75	2	0.1	\$	113.00	<ul style="list-style-type: none"> • Black with flip-lid top • Three USB 2.0 ports with a total of 2A power, card reader with SD/SDHC/MMC, MS Pro/Duo slots, External audio jack, 100-240V AC/DC 2A adapter, 6' digital cable, combined 3.5mm headphone/microphone jack and USB type A jack • Fits in Causeway tops and Pimlico EX Tables
						\$	497.00	
	Installation per Unit 0000-3199						\$	
 <p>TVS4113 0000-40</p>	7.5	2	1.5	2	0.2	\$	82.00	<ul style="list-style-type: none"> • Four power outlets, phone jack with phone cable, TV cable • AC125V 12A 60Hz rating • Overload protect switch with indicator light • SJT 14AWG/3C power cord • Factory installation not available. Includes hardware for attachment to desired location.
						\$	82.00	
	Installation per Unit 0000-0099						\$	
 <p>PC710 0000-41</p>				2	0.2	\$	77.00	<ul style="list-style-type: none"> • Black, one AC grounded outlet, one USB pass through, two USB chargers per DCSV IA • AC 125V 60Hz 10A rating • 8' 16AWGX3C power cord with ground plug <p>Note: Orders for installations cannot be cancelled</p>
						\$	452.00	
	Installation per Unit 0000-0099						\$	
 <p>Pop-Up Power Station 0000-42</p>	3.5	3.5	10	3	0.4	\$	135.00	<ul style="list-style-type: none"> • Black, two outlets, two DCSV 2.14 USB ports • AC 125V 60Hz, 12A max rating • 6' SJT 14AWG/3C power cord • Requires minimum 12" clearance under mounted surface for correct operation • Fits in Causeway tops and Pimlico EX Tables
						\$	497.00	
	Installation per Unit 0000-3199						\$	
 <p>Seclusion Power/Data Center 0000-43</p>						\$	360.00	<ul style="list-style-type: none"> • Two electrical outlets, two RJ45 ports • Works with Inigo High Top Conference Tables
						\$	360.00	
	Installation per Unit 0000-3199						\$	
 <p>Cove Power Center 0000-44</p>	6.5	2.5	3.5	1	0.1	\$	465.00	<ul style="list-style-type: none"> • Two electrical receptacles, two USB ports
						\$	465.00	
	Installation per Unit 0000-3199						\$	
 <p>Villa Power Center 0000-45</p>	10	4	3	1	0.1	\$	540.00	<ul style="list-style-type: none"> • Two electrical outlets, two RJ45 ports • Power cord is not included, use 0000-62
						\$	540.00	
	Installation per Unit 0000-3199						\$	
 <p>Interconnecting Cable for Villa Power Center 0000-65</p>				1	0.1	\$	169.00	
						\$	169.00	
	Installation per Unit 0000-3199						\$	
 <p>Villa Grommet 0000-66</p>	3.25	5.5		1		\$	130.00	<ul style="list-style-type: none"> • Recommended Table Cutout: 3.00" x 5.25" • Minimum Table Thickness: 1.00"
						\$	130.00	
	Installation per Unit 0000-3199						\$	

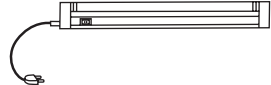

DMI COLLECTION

Item Description Model Number	W"	D"	H"	Weight Lbs.	Cubic Ft.	List Price	Features
Starter Cable Cords							• 15 amp
0000-61	72	2	1	1	0.1	\$ 205.00	
0000-62	54	2	1	1	0.1	\$ 290.00	
72" Connectory Cord							• Flexible metal; female/female end • Designed for use to daisy chaining power accessories together
0000-63	72	2	1	1	0.1	\$ 175.00	
 19" Task Light 0000-300	19	1.5	0.75	5	0.4	\$ 112.00	• 0000-300 is 16 watt lamp • 0000-400 is 21 watt lamp • Black framed fluorescent light • On/off switch
 35.75" Task Light 0000-400	35.75	1.5	0.75	8	0.2	\$ 147.00	• 10' SPT-2 black cord • UL & CUL listed
Optional Grommets for Conference Tables							• 0000-097 in Brushed Platinum finish • 0000-098 in Antique Brass finish • 0000-099 in Black finish <i>Note: Orders for installations cannot be cancelled</i>
0000-097				1	0.2	\$ 38.00	
0000-098				1	0.2	\$ 38.00	
0000-099				1	0.2	\$ 38.00	
Installation per Grommet						\$ 497.00	
0000-3199							

Installation Policy

- FLEXSTEEL COMMERCIAL will offer data port installations for Power and Data ports (P&D ports) sold by FLEXSTEEL COMMERCIAL, in standard, existing grommet locations on Expandable Tables, for a set installation fee listed in our price list.
- FLEXSTEEL COMMERCIAL will provide installations of P&D ports not sold by FLEXSTEEL COMMERCIAL in the existing grommet holes for a 35% up charge, provided the client supplies detailed drawings of direction the ports are to be installed and exact dimensions of the port.
- FLEXSTEEL COMMERCIAL Standard Conference Tables, outside the Ex-table program, are not engineered for data ports. There is no wire management support on the table or table bases. FLEXSTEEL COMMERCIAL may agree to install ports to these tables for a 50% up charge to standard installation charges if the client provides detailed signed off drawings for dimensions and locations of the ports. In these cases, FLEXSTEEL COMMERCIAL reserves the right to move data port locations if the desired location will interfere with table base support.
- Requests for grommets in conference tables without grommets are subject to a 35% up charge.
- In all cases, table orders with installed P&D ports, and grommets are not cancellable.

Accessories



FLEXSTEEL®
CONTRACT

DMI COLLECTION

Model Number	Item Description			Weight Lbs.	Cubic Ft.	List Price	Features	
	Model Number	W" D" H"						
	0000-101 18" x 68" (Black) \$407.00	0000-102 18" x 63" (Black) \$382.00	0000-103 18 x 44.5" (Black) \$312.00	0000-310 16.5" x 59.5" (Gray) \$264.00	0000-311 16.5" x 65.5" (Gray) \$264.00	0000-320 15.5" x 57" (Gray) \$264.00	0000-321 16.5" x 63" (Gray) \$256.00	0000-341 20.5" x 68" (Black) \$328.00
7004/7005/7006/7007-326			•					
7004/7005/7006/7007-426	•				•			
7004/7005/7006/7007-922		•						
7350-44							•	
7350-47							•	
7350-61					•	•		
7350-62					•	•		
7462-44							•	
7462-61						•		
7462-62							•	
7480-44						•		
7480-46							•	
7480-62						•		
7684-44				•				
7020/7027-61				•	•			
7020/7027-62				•	•			
7130/7132-62								•
7130/7132-63								•
7302-625								•
7302-404								•

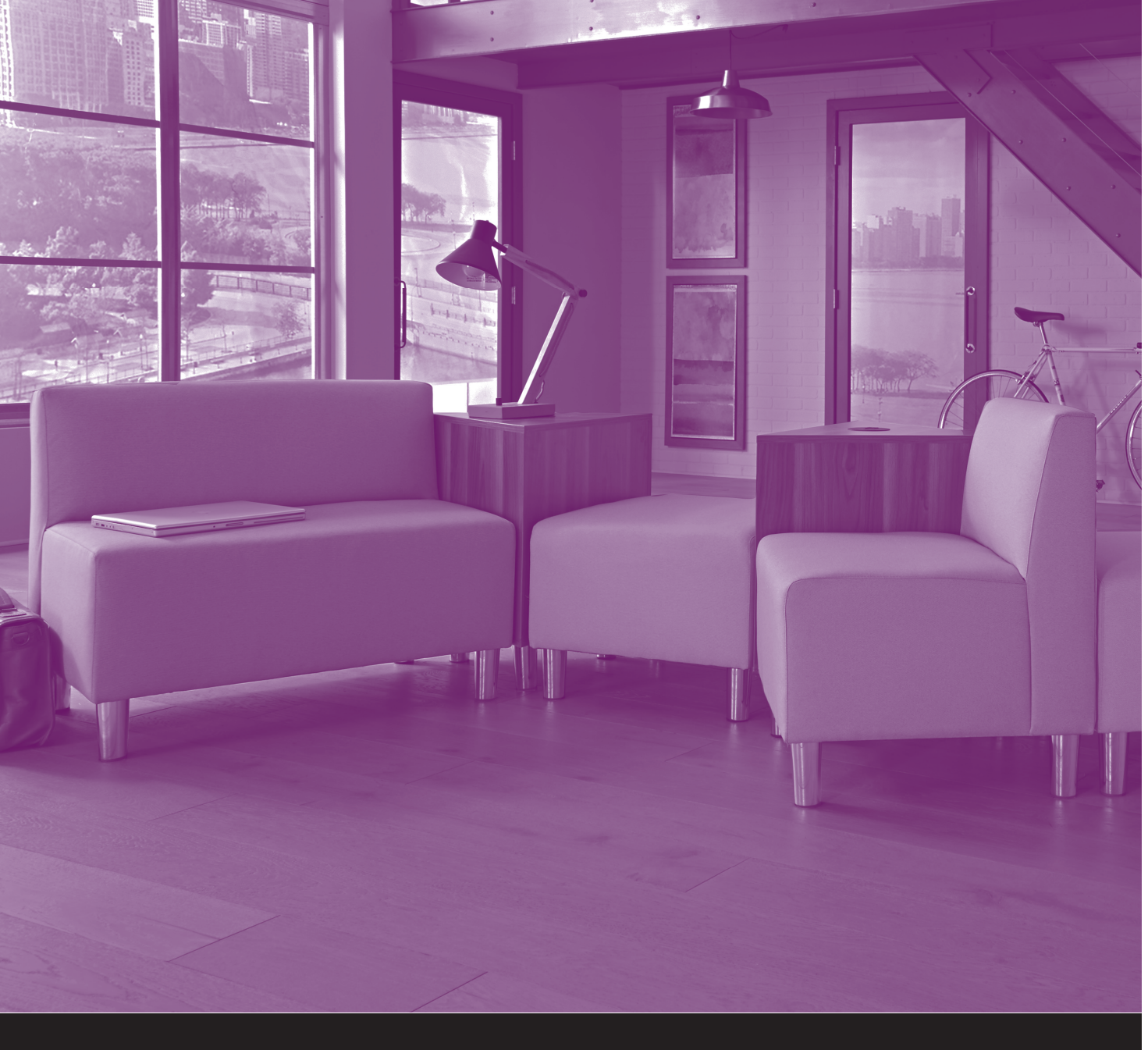

FLEXSTEEL®
CONTRACT

DMI COLLECTION

www.flexsteel.com

T 888.372.1927

© Flexsteel Industries, Inc. 1/1/2017